



# Service Repair Manual

## **Models**

# 936E WHEEL LOADER

---

[Previous Screen](#)

Product: WHEEL LOADER

Model: 936 WHEEL LOADER 33Z

Configuration: 936E WHEEL LOADER 33Z03091-UP (MACHINE) POWERED BY 3304 ENGINE

## Disassembly and Assembly 3304B and 3306B Engines for Caterpillar Built Machines

Media Number -SEN5598-09

Publication Date -01/01/2013

Date Updated -25/01/2013

i00985281

# Flywheel Housing - Remove and Install

SMCS - 1157-010

## Removal Procedure

Table 1

Required Tools			
Tool	Part Number	Part Description	Qty
A	138-7573	Link Bracket	2

### Start By:

- A. Remove the flywheel. Refer to Disassembly and Assembly, "Flywheel - Remove".
- B. Remove the crankshaft rear seal. Refer to Disassembly and Assembly, "Crankshaft Rear Seal - Remove".

---

### NOTICE

**Keep all parts clean from contaminants.**

**Contaminants may cause rapid wear and shortened component life.**

---

1. Remove the bolts that hold the oil pan plate to the flywheel housing. Loosen the remaining bolts that hold the oil pan plate in position. Put spacers between the cylinder block and the oil pan plate. This must be done in order to prevent damage to the gasket for the oil pan plate.

**Note:** If the gasket for the oil pan plate is damaged, the oil pan plate must be removed. Refer to Disassembly and Assembly, "Engine Oil Pan Plate - Remove and Install".

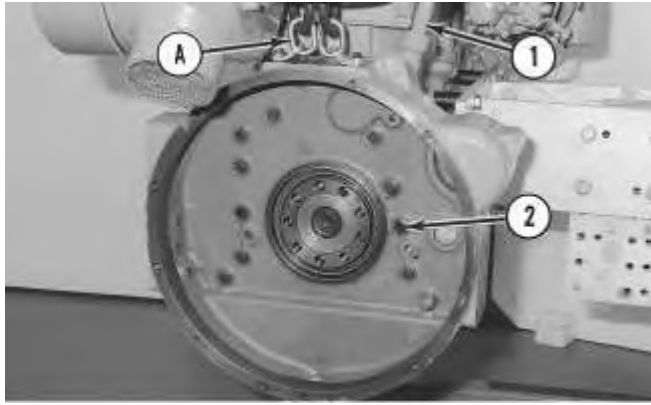

---

Illustration 1

g00516402

2. Remove turbocharger oil drain line (1) .
3. Install Tool (A) on the flywheel housing. Fasten a hoist to Tool (A) on the flywheel housing.
4. Remove all bolts (2) and the flywheel housing from the engine. The weight of the flywheel housing is 37 kg (82 lb).

## Installation Procedure

Table 2

Required Tools			
Tool	Part Number	Part Description	Qty
A	138-7573	Link Bracket	2

---

### NOTICE

**Keep all parts clean from contaminants.**

**Contaminants may cause rapid wear and shortened component life.**

---

1. Put the gasket in position and use a hoist to put the flywheel housing in position on the engine.
-

**<https://www.ebooklibonline.com>**

Hello dear friend!

Thank you very much for reading.

Enter the link into your browser.

The full manual is available for immediate download.

**<https://www.ebooklibonline.com>**

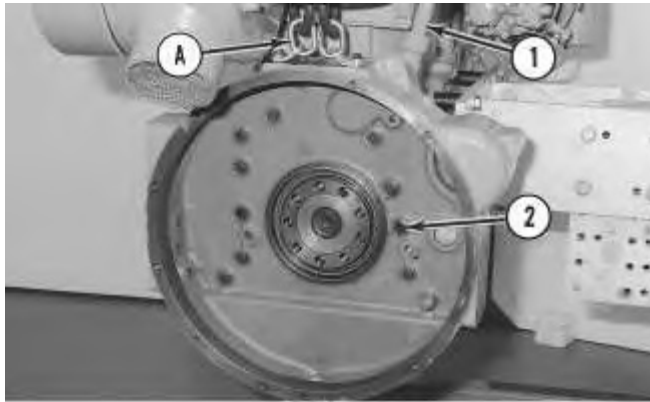

Illustration 2

g00516402

2. Install all bolts (2) that hold the flywheel in position on the engine. Tighten the bolts to a torque of  $100 \pm 14 \text{ N}\cdot\text{m}$  ( $74 \pm 10 \text{ lb ft}$ ).
3. Remove Tool (A) and the hoist from the engine.
4. Install turbocharger oil drain line (1) .
5. Trim the flywheel housing gasket so the gasket is even with the bottom of the cylinder block.

**Note:** If the oil pan plate was removed, install a new gasket and install the oil pan plate. Refer to Disassembly and Assembly, "Engine Oil Pan Plate - Remove and Install".

6. Apply **3S-6252** Sealant to the contact point between the oil pan plate gasket and the flywheel housing gasket.
7. Remove the spacers that were installed between the cylinder block and the oil pan plate. Install the bolts that hold the oil pan plate to the flywheel housing. Tighten the remaining bolts that hold the oil pan plate to the cylinder block.

### End By:

- a. Install the crankshaft rear seal. Refer to Disassembly and Assembly, "Crankshaft Rear Seal - Install".
- b. Install the flywheel. Refer to Disassembly and Assembly, "Flywheel - Install".

[Previous Screen](#)

Product: WHEEL LOADER

Model: 936 WHEEL LOADER 33Z

Configuration: 936E WHEEL LOADER 33Z03091-UP (MACHINE) POWERED BY 3304 ENGINE

## Disassembly and Assembly 3304B and 3306B Engines for Caterpillar Built Machines

Media Number -SEN5598-09

Publication Date -01/01/2013

Date Updated -25/01/2013

i01005265

# Vibration Damper and Pulley - Remove and Install

SMCS - 1205-010

## Removal Procedure

Table 1

Required Tools			
Tool	Part Number	Part Description	Qty
A	FT-0915	Adapter	1
	0S-1590	Bolt	6
	5F-7342	Adapter	2
	5F-7369	Puller Leg	2
	3H-0465	Push Puller Plate	4
	1B-4207	Full Nut	2
	8B-7560	Step Plate	1
	1P-0820	Hydraulic Puller	1
	4C-4865	Hand Hydraulic Pump	1

### Start By:

- A. Relieve the tension on the drive belt and remove the drive belt.

---

### NOTICE

**Keep all parts clean from contaminants.**

**Contaminants may cause rapid wear and shortened component life.**

---

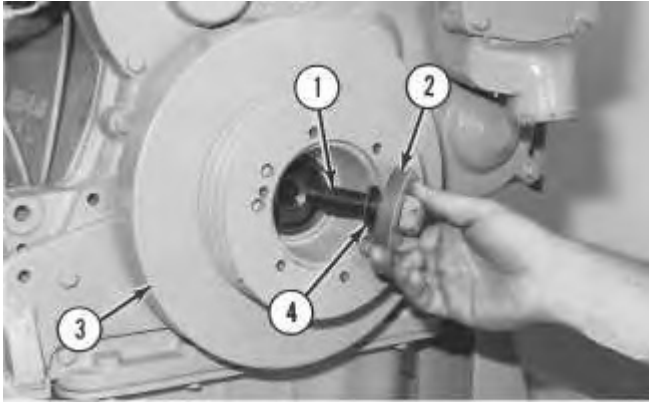

Illustration 1

g00515722

1. Remove bolt (1) and washer (2) from the crankshaft. Install spacers (4) on bolt (1). Add spacers in order to obtain approximately 3.18 mm (0.125 inch) of clearance between washer (2) and vibration damper (3). Install bolt (1), washer (2) and spacers (4) .

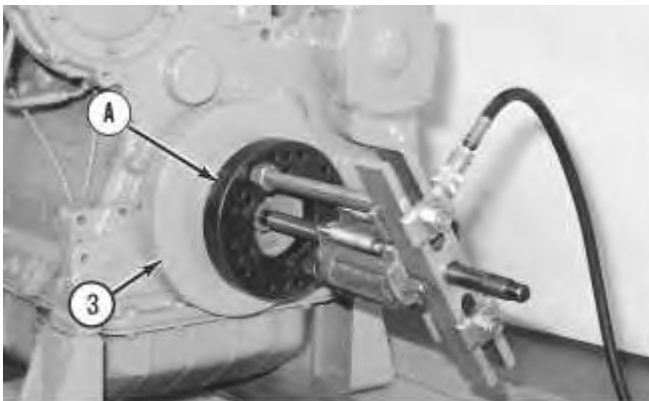

Illustration 2

g00515749

2. Install Tool (A), as shown. Loosen vibration damper (9) from the crankshaft.
3. Remove Tool (A), bolt (1), washer (2), spacers (4) and vibration damper (3) from the crankshaft.

## **Installation Procedure**

---

**NOTICE**

**Keep all parts clean from contaminants.**

**Contaminants may cause rapid wear and shortened component life.**

---

**Note:** Inspect the vibration damper for leaks and dents. If either condition exists, replace the vibration damper with a new part.

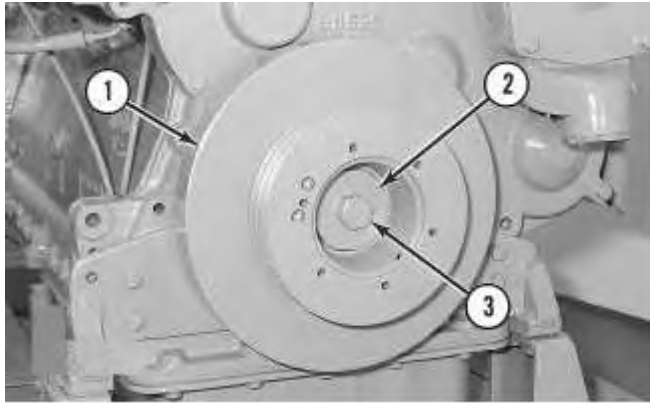

Illustration 3

g00515758

1. Put vibration damper (1) in position on the crankshaft and install washer (2) and bolt (3) .

**Note:** The flat side of washer (2) must be installed facing vibration damper (1) .

2. Tighten bolt (3) to a torque of 284 to 340 N·m (210 to 250 lb ft). Hit bolt (3) with a hammer and torque the bolt again to 284 to 340 N·m (210 to 250 lb ft).

**End By:** Install the drive belt and apply the correct tension.

---

Previous Screen

Product: WHEEL LOADER

Model: 936 WHEEL LOADER 33Z

Configuration: 936E WHEEL LOADER 33Z03091-UP (MACHINE) POWERED BY 3304 ENGINE

**Disassembly and Assembly  
3304B and 3306B Engines for Caterpillar Built Machines**

Media Number -SEN5598-09

Publication Date -01/01/2013

Date Updated -25/01/2013

i00990465

## Crankshaft Front Seal - Remove

SMCS - 1160-011

### Removal Procedure

Table 1

Required Tools			
Tool	Part Number	Part Description	Qty
A	1P-0510	Driver Group	1
B	5P-7315	Wear Sleeve Distorter Ring	1
C	5P-7312	Seal Distorter	1

**Start By:**

- A. Remove the vibration damper and the pulley. Refer to Disassembly and Assembly, "Vibration Damper and Pulley - Remove and Install".

---

**NOTICE**

**Keep all parts clean from contaminants.**

**Contaminants may cause rapid wear and shortened component life.**

---



---

**NOTICE**

**Care must be taken to ensure that fluids are contained during performance of inspection, maintenance, testing, adjusting and repair of the machine. Be prepared to collect the fluid with suitable containers before opening any compartment or disassembling any component containing fluids.**

**Refer to Special Publication, NENG2500, "Caterpillar Tools and Shop Products Guide", for tools and supplies suitable to collect and contain fluids in Caterpillar machines.**

**Dispose of all fluids according to local regulations and mandates.**

---

**Note:** When a crankshaft seal is replaced, the wear sleeve must also be replaced.

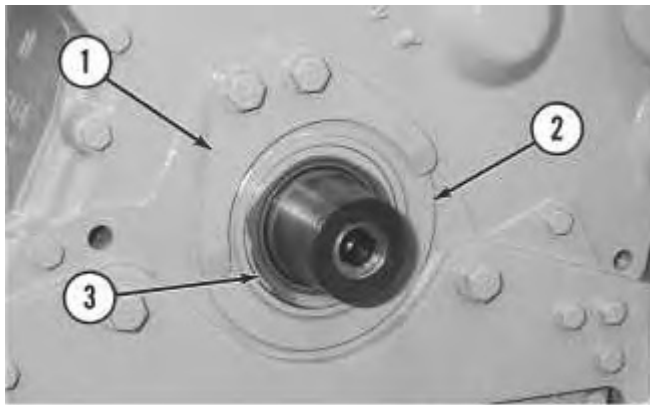

---

Illustration 1

g00504503

1. Remove the two bolts, washers, spacers and clamp (1) that holds crankshaft seal adapter (2) in position. Remove crankshaft seal adapter (2) and the O-ring seal from the engine.
  2. Use Tool (A) and a press to remove the crankshaft seal from crankshaft seal adapter (2) .
  3. Install the O-ring seal and crankshaft seal adapter (2) on the engine. Install the two bolts, washers, spacers and clamp (1) to hold crankshaft seal adapter (2) in position.
-

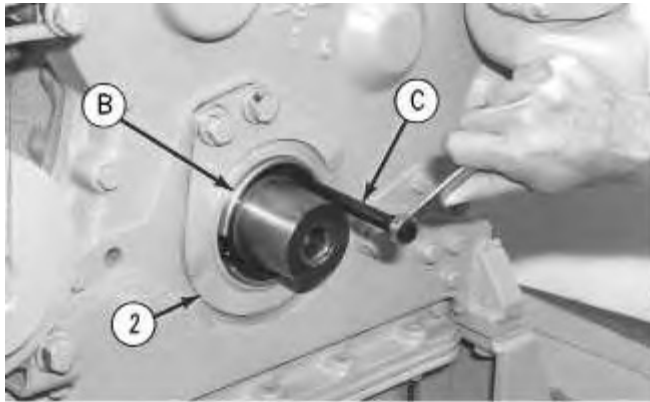

Illustration 2

g00510634

4. Install Tool (B) in the bore of seal adapter (2), as shown.

---

### NOTICE

**Care should be taken to ensure that the seal distorter does not cut through the wear sleeve. Damage to the crankshaft surface may occur leading to possible oil seal leaks.**

---

5. Install Tool (C) between Tool (B) and the wear sleeve. Turn Tool (C) with a wrench, until the edge of the tool makes a flat crease in the wear sleeve. Repeat this process until there are enough creases in the wear sleeve in order to allow the wear sleeve to be slipped off the end of the crankshaft.
6. Remove Tools (B) and (C). Remove the wear sleeve by hand.

Previous Screen

Product: WHEEL LOADER

Model: 936 WHEEL LOADER 33Z

Configuration: 936E WHEEL LOADER 33Z03091-UP (MACHINE) POWERED BY 3304 ENGINE

**Disassembly and Assembly  
3304B and 3306B Engines for Caterpillar Built Machines**

Media Number -SEN5598-09

Publication Date -01/01/2013

Date Updated -25/01/2013

i06015907

## Crankshaft Front Seal - Install

SMCS - 1160-012

### Installation Procedure

Table 1

Required Tools			
Tool	Part Number	Part Description	Qty
A	4C-8982 <sup>(1)</sup>	Installer	1
	438-9547 <sup>(2)</sup>	Installer	1
	7F-8022	Bolt	1

<sup>(1)</sup> Use to install 9Y-9895 seal

<sup>(2)</sup> Use to install 362-8853 seal

---

**NOTICE**

**Keep all parts clean from contaminants.**

**Contaminants may cause rapid wear and shortened component life.**

---

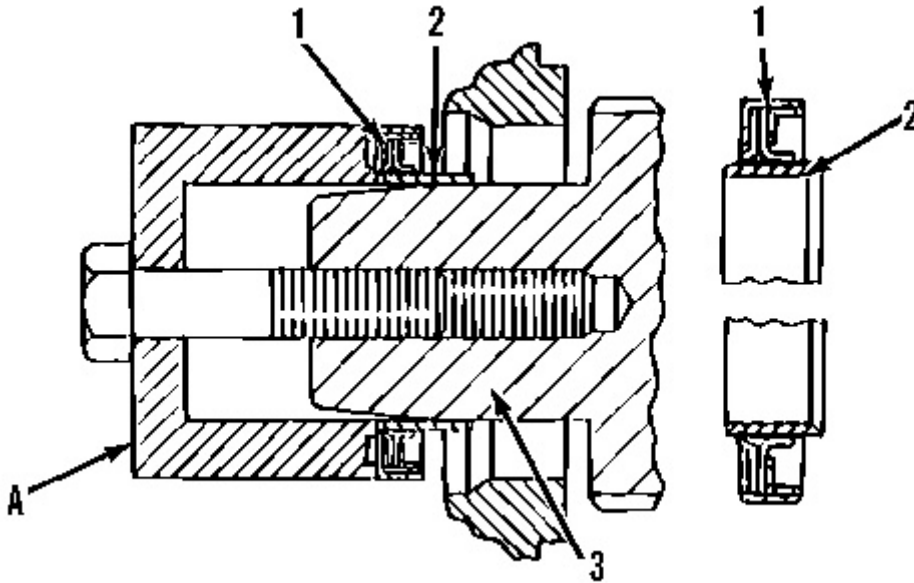

Illustration 1

g00488110

**Note:** Once the seal and the wear sleeve are separated, these components cannot be used again. Refer to Special Instruction, SMHS8508 before the seal is serviced.

**Note:** Do not use any type of lubricant during the installation of the crankshaft seal and wear sleeve.

**Note:** Before installing the wear sleeve, inspect the crankshaft for scratches or any distortion on the surface of the crankshaft that may lead to an out of round condition. Use a polishing cloth to clean the imperfections on the crankshaft.

1. Install crankshaft front seal (1) and wear sleeve (2) with Tool (A) , as follows:
  - a. Use **4C-9500** Quick Cure Primer to clean the outside diameter of crankshaft (3) and the inside diameter of wear sleeve (2) .
  - b. Apply **4C-9507** Compound to the outside diameter of crankshaft (3) and the inside diameter of wear sleeve (2) .
  - c. Place crankshaft front seal (1) and wear sleeve (2) on the front of crankshaft (3) .  
Install Tool (A) and tighten until the inside surface of the Installer comes in contact with the end of the crankshaft.

**End By:** Install the vibration damper and the pulley. Refer to Disassembly and Assembly, "Vibration Damper and Pulley - Remove and Install".

[Previous Screen](#)

Product: WHEEL LOADER

Model: 936 WHEEL LOADER 33Z

Configuration: 936E WHEEL LOADER 33Z03091-UP (MACHINE) POWERED BY 3304 ENGINE

## Disassembly and Assembly 3304B and 3306B Engines for Caterpillar Built Machines

Media Number -SEN5598-09

Publication Date -01/01/2013

Date Updated -25/01/2013

i02107004

## Gear Group (Front) - Remove

SMCS - 1206-011

### Removal Procedure

Table 1

Required Tools			
Tool	Part Number	Part Description	Qty
A	1P-0510	Driver Group	1

#### Start By:

- A. Remove the automatic timing advance unit. Refer to Disassembly and Assembly, "Automatic Timing Advance - Remove".

---

### NOTICE

**Keep all parts clean from contaminants.**

**Contaminants may cause rapid wear and shortened component life.**

---

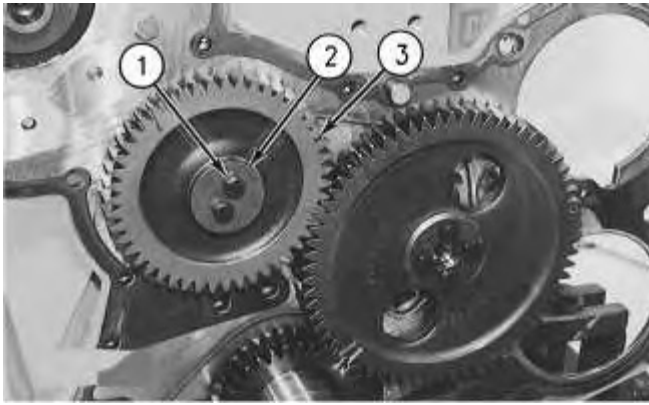

Illustration 1

g00476414

1. Remove bolts (1), plate (2), and fuel pump idler gear (3) .

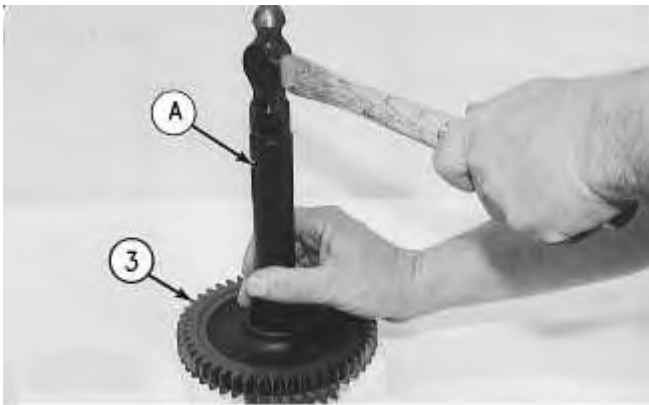

Illustration 2

g00476416

2. Remove the bearing from fuel pump idler gear (3) with Tooling (A) .

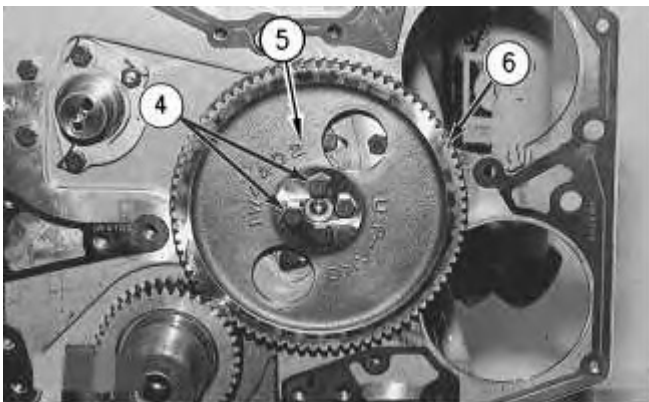

Illustration 3

g00476417

3. Remove bolts (4), plate (5), and camshaft gear (6) .

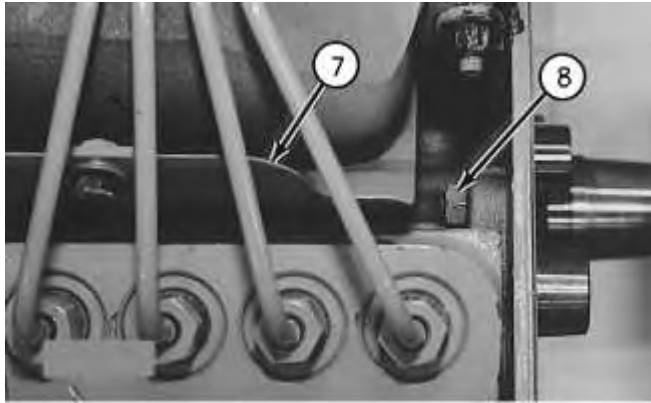

Illustration 4

g00476418

4. Remove the bolts that hold shield (7) in position between the fuel pump and the exhaust manifold. Slide the shield backward from the timing cover plate.
5. Remove nuts (8) .

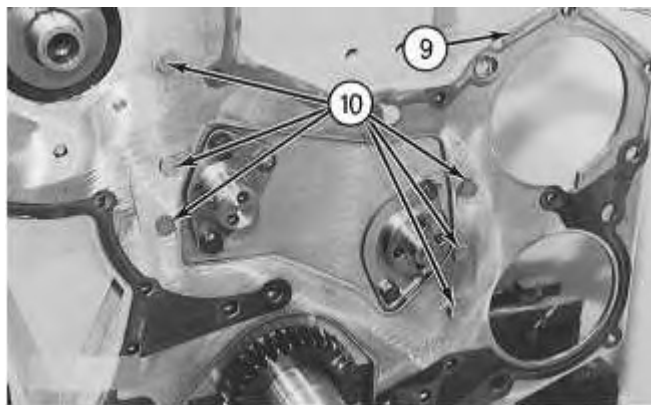

Illustration 5

g00476419

6. Remove bolts (10). Remove timing gear plate (9) and the gasket.

Previous Screen

Product: WHEEL LOADER

Model: 936 WHEEL LOADER 33Z

Configuration: 936E WHEEL LOADER 33Z03091-UP (MACHINE) POWERED BY 3304 ENGINE

## Disassembly and Assembly 3304B and 3306B Engines for Caterpillar Built Machines

Media Number -SEN5598-09

Publication Date -01/01/2013

Date Updated -25/01/2013

i02107019

# Gear Group (Front) - Install

SMCS - 1206-012

## Installation Procedure

Table 1

Required Tools			
Tool	Part Number	Part Description	Qty
A	1P-0510	Driver Group	1
B	9S-3263	Thread Lock Compound	1

---

### NOTICE

**Keep all parts clean from contaminants.**

**Contaminants may cause rapid wear and shortened component life.**

---

**Note:** Check the condition of the gaskets and the O-ring seals. If the gaskets or the O-ring seals are worn or damaged, use new parts for replacement.

1. Clean the old gasket from the contact surfaces of the timing gear plate and the cylinder block. Install a new gasket on the cylinder block. Cut the gasket even with the bottom face of the cylinder block.
-

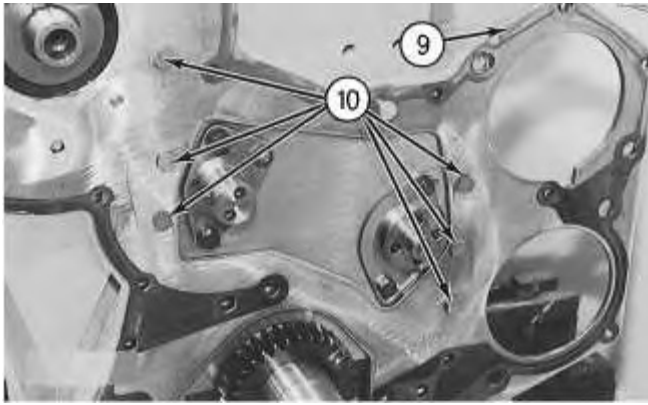

Illustration 1

g00476419

---

## NOTICE

**The bolts that hold the timing gear plate in position on the cylinder block should have a reduced bolt head thickness. The reduced bolt head thickness is needed for clearance for the gears.**

---

2. Ensure that the O-ring seals are in position on the end of the fuel injection pump housing. Put timing gear plate (9) in position on the cylinder block. Install bolts (10) .

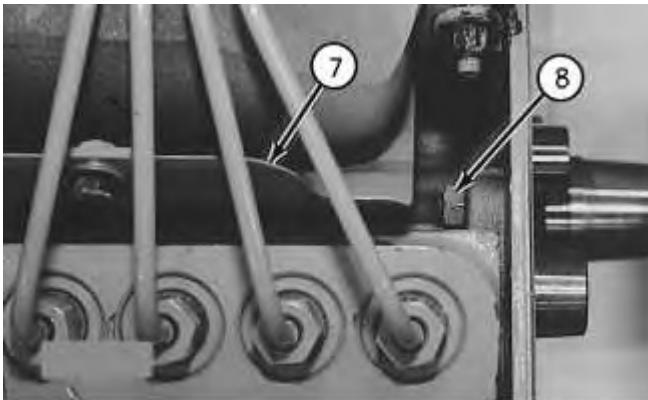

Illustration 2

g00476418

3. Install shield (7). Install nuts (8) .

**Note:** After the timing gear plate is installed, ensure that the rack is free to move in the fuel injection pump housing. The O-ring seal on the drive end of the fuel injection pump housing can hold the rack. This can help prevent free rack movement. Rack movement can be seen through a hole in the timing gear plate just above the mounting of the fuel pump gear. If the rack does not move freely, remove the timing gear plate and check the O-ring seal on the drive end of the fuel injection pump housing.

## **WARNING**

**If the rack does not move freely, the engine can over speed and be damaged. Serious personal injury may result.**

---

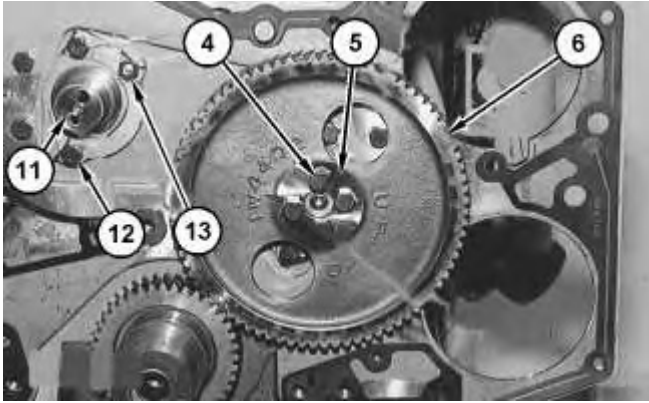

Illustration 3

g01072912

**Note:** If idler gear shaft (11) for the fuel pump idler gear was removed, use Tooling (B) on the threads of bolts (12) and nut (13) before reinstalling idler gear shaft (11). Tighten bolts (12) and nut (13) to a torque of  $50 \pm 10$  N·m ( $37 \pm 7$  lb ft).

- Put camshaft gear (6) and plate (5) in position on the engine. Align the Mark "C" on the camshaft gear with the Mark "C" on the crankshaft gear. Install bolts (4) and tighten bolts (4) to a torque of  $55 \pm 7$  N·m ( $41 \pm 5$  lb ft).

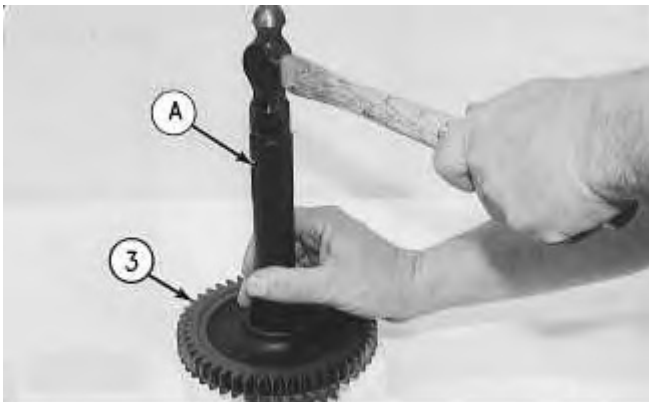

Illustration 4

g00476416

- Use Tooling (A) in order to install the bearing in fuel pump idler gear (3). The end of the bearing must be  $3.00 \pm 0.25$  mm ( $.118 \pm .010$  inch) below the face of the hub of the fuel pump idler gear.

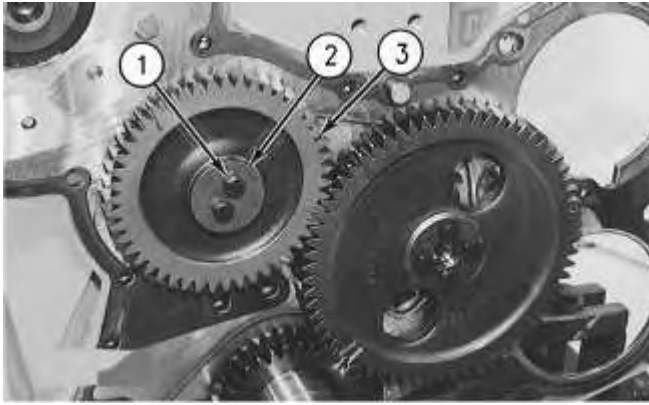

Illustration 5

g00476414

6. Ensure that the oil hole in the shaft for fuel pump idler gear (3) is open. Install fuel pump idler gear (3). Put plate (2) in position with the finished side facing toward fuel pump idler gear (3). Apply Tooling (B) on bolts (1). Install bolts (1) that hold fuel pump idler gear (3) in position.

**Note:** Remove excess Tooling (B) on plate (2). Excess Tooling (B) on plate (2) may flow into the gear bearings. This condition can affect lubrication. Bearing life can also be affected.

**End By:** Install the automatic timing advance unit. Refer to Disassembly and Assembly, "Automatic Timing Advance - Install".

[Previous Screen](#)

Product: WHEEL LOADER

Model: 936 WHEEL LOADER 33Z

Configuration: 936E WHEEL LOADER 33Z03091-UP (MACHINE) POWERED BY 3304 ENGINE

## Disassembly and Assembly 3304B and 3306B Engines for Caterpillar Built Machines

Media Number -SEN5598-09

Publication Date -01/01/2013

Date Updated -25/01/2013

i02107163

## Housing (Front) - Remove

SMCS - 1151-011

### Removal Procedure

#### Start By:

- A. Remove the water pump. Refer to Disassembly and Assembly, "Water Pump - Remove".
- B. Remove the crankshaft front seal. Refer to Disassembly and Assembly, "Crankshaft Front Seal - Remove".

---

#### NOTICE

**Keep all parts clean from contaminants.**

**Contaminants may cause rapid wear and shortened component life.**

---

---

#### NOTICE

**Care must be taken to ensure that fluids are contained during performance of inspection, maintenance, testing, adjusting and repair of the product. Be prepared to collect the fluid with suitable containers before opening any compartment or disassembling any component containing fluids.**

**Refer to Special Publication, NENG2500, "Caterpillar Tools and Shop Products Guide" for tools and supplies suitable to collect and contain fluids on Caterpillar products.**

**Dispose of all fluids according to local regulations and mandates.**

- 
1. Remove the bolts that hold the oil pan and the oil pan plate to the front housing. Loosen the remaining bolts that hold the oil pan in position. Put spacers between the cylinder block and the oil pan plate. This must be done in order to prevent damage to the gasket for the oil pan plate.

**Note:** If the gasket for the oil pan plate is damaged, the oil pan plate must be removed. Refer to Disassembly and Assembly, "Engine Oil Pan Plate - Remove and Install".

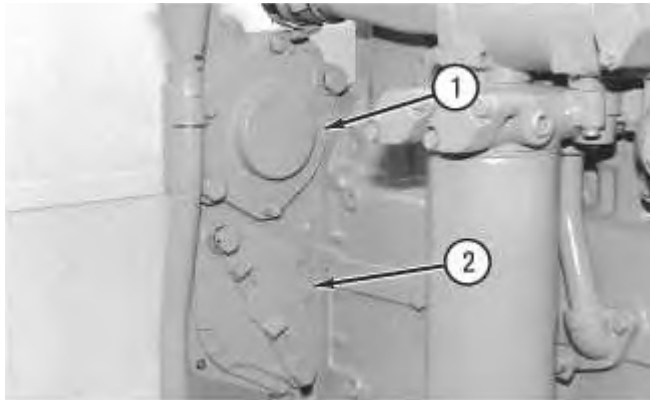

Illustration 1

g00512114

2. Remove covers (1) and (2) from the back of the front plate.

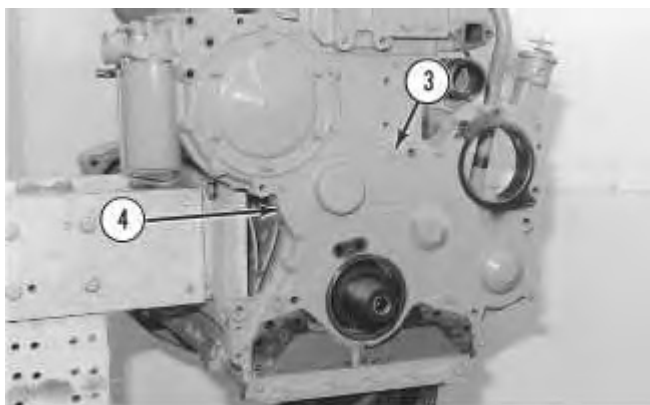

Illustration 2

g00512122

3. Remove all bolts (3) that hold front housing (4) in position on the engine. Remove front housing (4) and the gasket from the engine.



**Suggest:**

**If the above button click is invalid.**

**Please download this document**

**first, and then click the above link**

**to download the complete manual.**

**Thank you so much for reading**

[Previous Screen](#)

Product: WHEEL LOADER

Model: 936 WHEEL LOADER 33Z

Configuration: 936E WHEEL LOADER 33Z03091-UP (MACHINE) POWERED BY 3304 ENGINE

## Disassembly and Assembly 3304B and 3306B Engines for Caterpillar Built Machines

Media Number -SEN5598-09

Publication Date -01/01/2013

Date Updated -25/01/2013

i02107191

## Housing (Front) - Install

SMCS - 1151-012

## Installation Procedure

Table 1

Required Tools			
Tool	Part Number	Part Description	Qty
A	3S-6252	Sealant	1

---

### NOTICE

**Keep all parts clean from contaminants.**

**Contaminants may cause rapid wear and shortened component life.**

---

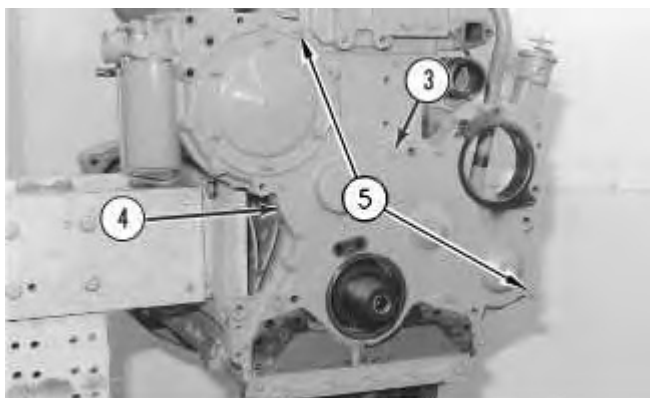

**<https://www.ebooklibonline.com>**

Hello dear friend!

Thank you very much for reading.

Enter the link into your browser.

The full manual is available for immediate download.

**<https://www.ebooklibonline.com>**