



# Service Repair Manual

## **Models**

330C and 330C L Excavator

---

[Previous Screen](#)

Product: EXCAVATOR

Model: 330C EXCAVATOR JCD

Configuration: 330C &amp; 330C L Excavators JCD00001-UP (MACHINE) POWERED BY C-9 Engine

## Disassembly and Assembly 330C Excavator Machine Systems

Media Number -REN5438-14

Publication Date -01/04/2010

Date Updated -13/04/2010

i03124522

# Travel Motor - Disassemble

SMCS - 4351-015

## Disassembly Procedure

Table 1

Required Tools			
Tool	Part Number	Part Description	Qty
A	1U-7506	Adapter	1
	8T-4244	Nut	6
	8T-4223	Hard Washer	6
	-	Threaded RodM12 x 1.75 by 250 mm (10 in) long	1
B	8T-0651	Bolt	1
	8T-4167	Hard Washer	1
C	3E-3882	Eyebolt	1
D	1P-1859	Retaining Ring Pliers	1
E	1P-0510	Driver Gp	1
	9S-9152	Bearing Puller Gp	1
F	1P-1861	Retaining Ring Pliers	1

### Start By:

- A. Remove the travel motor. Refer to Disassembly and Assembly, "Travel Motor - Remove".
-

## NOTICE

Care must be taken to ensure that fluids are contained during performance of inspection, maintenance, testing, adjusting and repair of the product. Be prepared to collect the fluid with suitable containers before opening any compartment or disassembling any component containing fluids.

Refer to Special Publication, NENG2500, "Caterpillar Dealer Service Tool Catalog" for tools and supplies suitable to collect and contain fluids on Caterpillar products.

Dispose of all fluids according to local regulations and mandates.

- 
1. Thoroughly clean the outside of the travel motor prior to disassembly.
  2. Fasten the travel motor in Tooling (A) in a vertical position. The weight of the travel motor is approximately 60 kg (132 lb).
  3. Put an alignment mark across the head and the body of the travel motor for assembly purposes. The head must be reinstalled in the head's original position on the body of the travel motor.



Illustration 1

g00887295

**Note:** During the removal of head (2) from the travel motor, be careful not to damage the mating surfaces of the components.



**Spring force can cause personal injury or death.**

**Do not repair until you have read the Operation and Maintenance Manual.**

**<https://www.ebooklibonline.com>**

Hello dear friend!

Thank you very much for reading.

Enter the link into your browser.

The full manual is available for immediate download.

**<https://www.ebooklibonline.com>**

- 
4. Remove bolts (1) .
  5. Remove head (2) from the body of the travel motor.

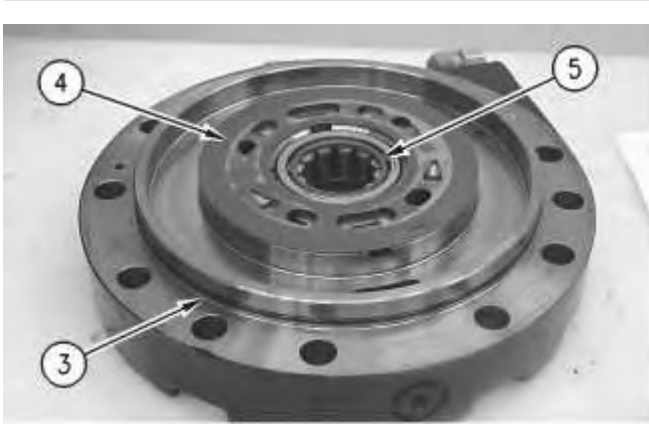

Illustration 2

g00887302

6. Remove O-ring seal (3) , port plate (4) , and bearing (5) .

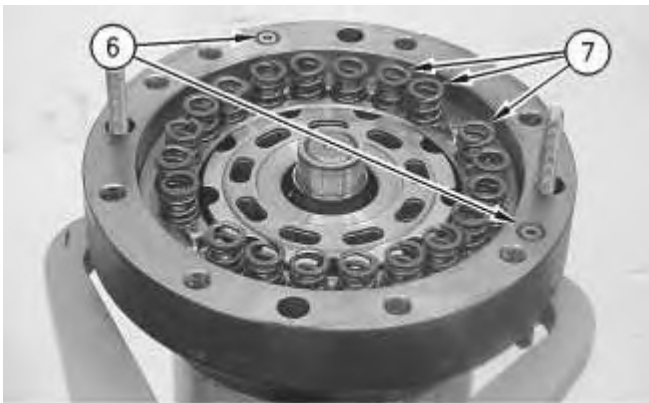

Illustration 3

g00887311

7. Remove O-ring seals (6) . Remove springs (7) .
-

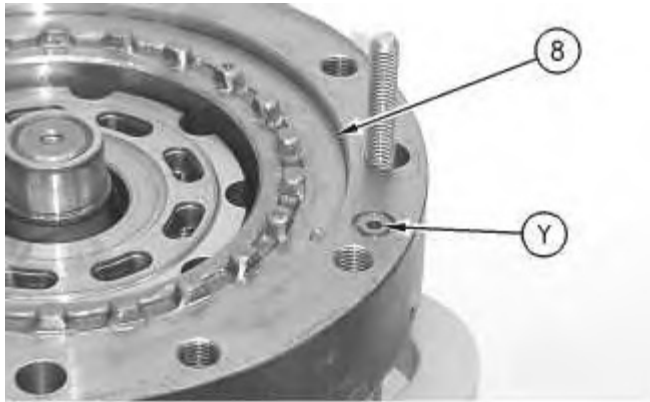

Illustration 4

g00887331

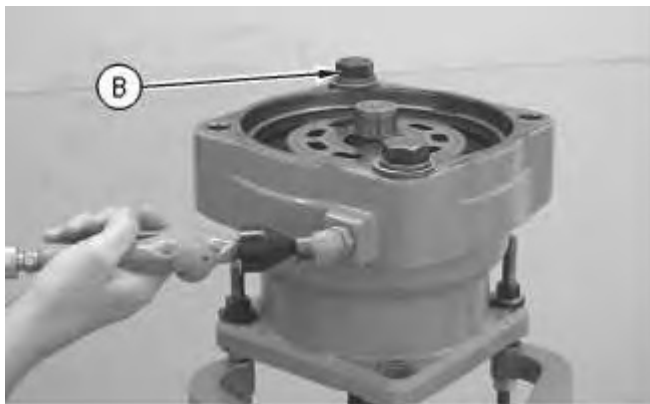

Illustration 5

g00890074

This is an example of the use of Tooling (B) .

8. Place a shop towel over brake piston (8) . Retain brake piston (8) with Tooling (B) . Apply approximately 525 kPa (75 psi) of shop air pressure to brake release Port (Y) . Make sure that the shop air pressure is free of water. Brake piston (8) will move up the piston guide, and out of the piston guide. Remove brake piston (8) from the body of the travel motor.



9. Remove seal (9) and backup ring (10) from the brake piston.
10. Remove seal (11) and backup ring (12) from the brake piston.

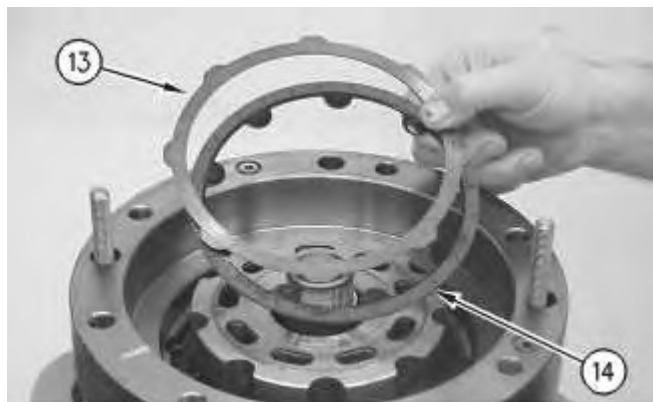

Illustration 7

11. Remove plates (13) and friction discs (14) .

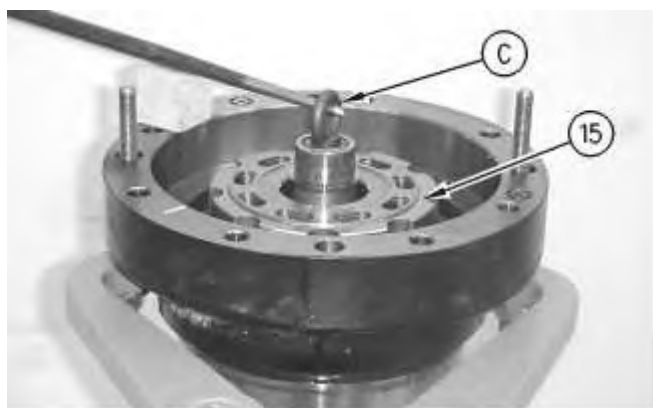

Illustration 8

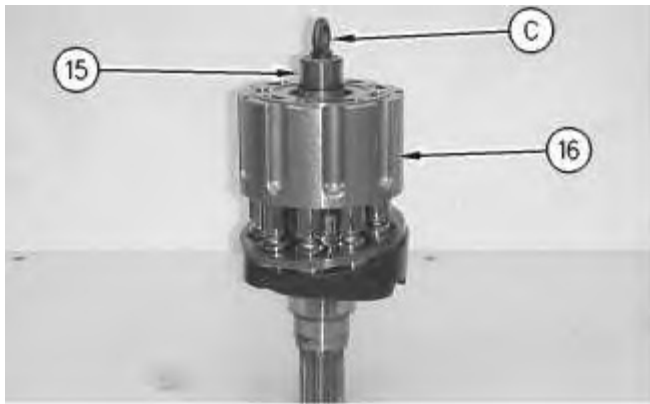

Illustration 9

g00887405

12. Install Tooling (C) into shaft (15) . Use a prybar to remove the rotating assembly (16) from the housing.
13. Remove Tooling (C) from shaft (15) .

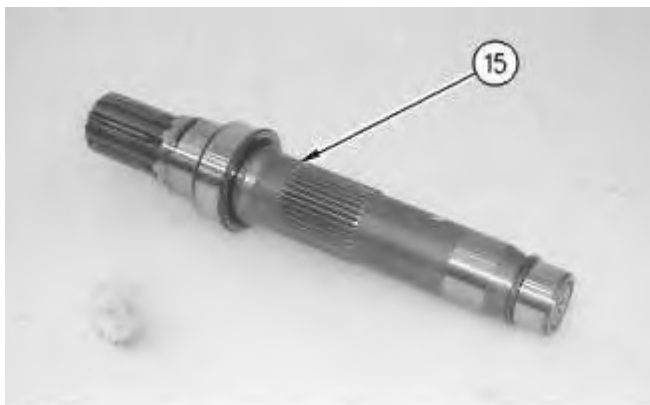

Illustration 10

g00887424

14. Remove shaft (15) from rotating assembly (16) .



15. Use Tooling (D) in order to remove retaining ring (17) from shaft (15) .

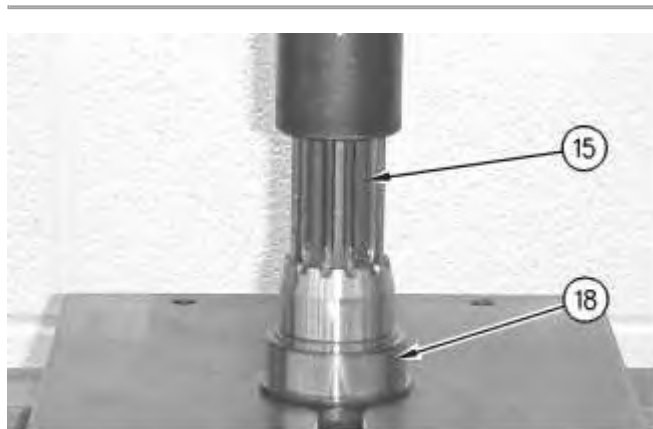

Illustration 12

16. Install shaft (15) into a suitable press. Remove bearing race (18) from the shaft.

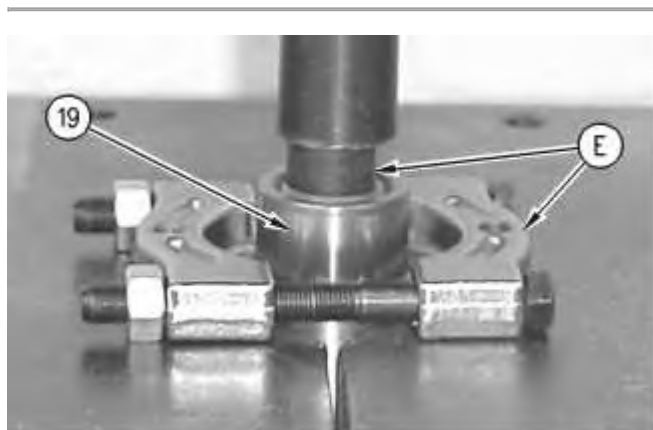

Illustration 13

17. Rotate shaft (15) . Install shaft (15) into a suitable press. Install Tooling (E) . Remove bearing race (19) from shaft (15) .
-



Illustration 14

g00887501

18. Remove cam plate (20) from barrel assembly (21) .



Illustration 15

g00887520

19. Remove piston assemblies and retainer plate (22) from barrel assembly (21) .

**Note:** Place marks on the pistons and the barrel assembly. The pistons must be returned to the original position.



20. Remove ball (23) and springs (24) .

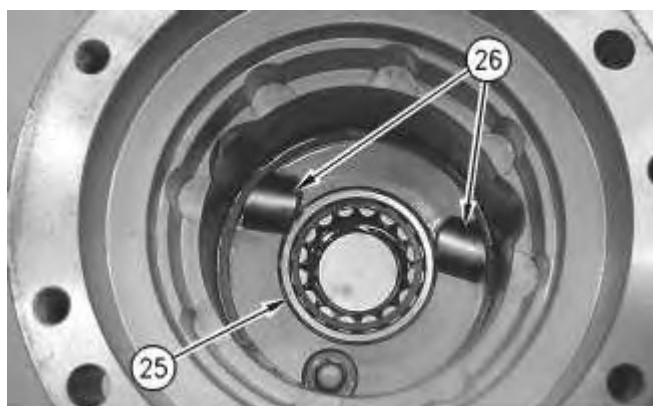

Illustration 17

21. Remove bearing (25) .
22. Remove keys (26) and locating pins (not shown) from the body of the travel motor.

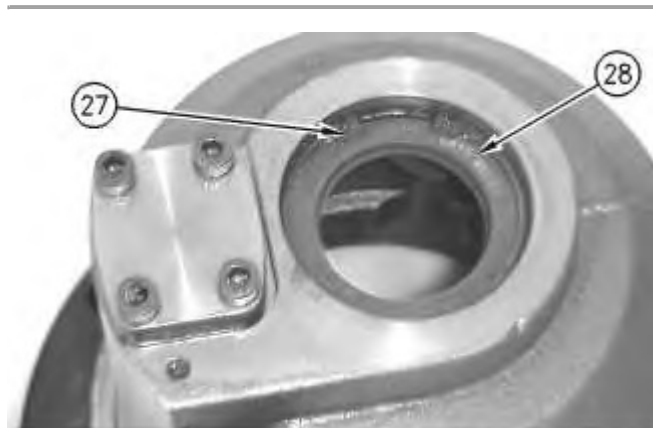

Illustration 18

23. Rotate the housing. Use Tooling (F) in order to remove retaining ring (27) .
  24. Remove seal (28) .
-

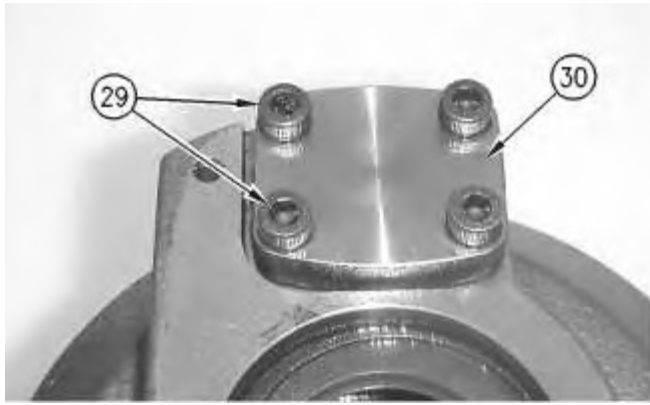

Illustration 19

g00887619

25. Remove bolts (29) and cover (30) .



Illustration 20

g00887729

26. Remove seal (31) and backup ring (32) .



Illustration 21

g00887754

27. Remove piston actuator (33) and seal (34) .



---

Illustration 22

g00887762

28. Remove O-ring seal (35) from the housing of the travel motor.

[Previous Screen](#)

Product: EXCAVATOR

Model: 330C EXCAVATOR JCD

Configuration: 330C &amp; 330C L Excavators JCD00001-UP (MACHINE) POWERED BY C-9 Engine

## Disassembly and Assembly 330C Excavator Machine Systems

Media Number -REN5438-14

Publication Date -01/04/2010

Date Updated -13/04/2010

i03124523

# Travel Motor - Assemble

SMCS - 4351-016

## Assembly Procedure

Table 1

Required Tools			
Tool	Part Number	Part Description	Qty
A	1U-7506	Adapter	1
	8T-4244	Nut	6
	8T-4223	Hard Washer	6
	-	Threaded Rod M12 x 1.75 X 250 mm (10 in) long	1
C	3E-3882	Eyebolt	1
D	1P-1859	Retaining Ring Pliers	1
E	1P-0510	Driver Gp	1
	9S-9152	Bearing Puller Gp	1
F	1P-1861	Retaining Ring Pliers	1
G	9S-3263	Thread Lock Compound	-

**Note:** Replace all O-ring seals and gaskets. Apply a light film of "10W" oil to all components before assembly.

**Note:** Cleanliness is an important factor. Before assembly, all parts should be thoroughly cleaned in cleaning fluid. Allow the parts to air dry. Wiping cloths or rags should not be used to dry parts. Lint may be deposited on the parts which may cause trouble later. Inspect all parts. If any parts are worn or damaged, use new parts for replacement. All disassembly and all assembly procedures

must be performed on a clean work surface and in a clean hydraulic area. Keep cleaned parts covered and protected at all times.



Illustration 1

g00887762

1. Install O-ring seal (35) onto the housing of the travel motor.

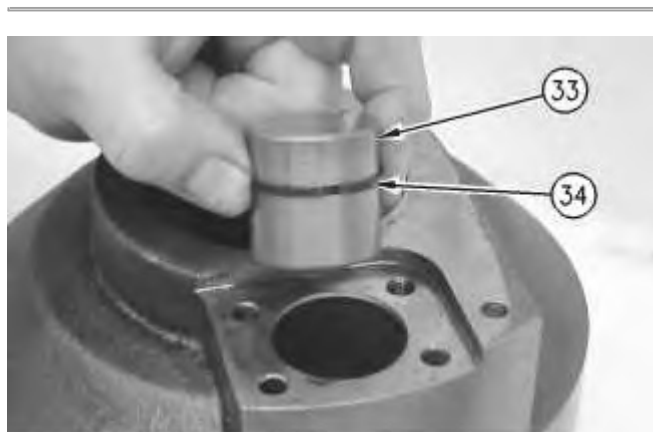

Illustration 2

g00887754

2. Install seal (34) and piston actuator (33) .
-



Illustration 3

g00887729

3. Install backup ring (32) and seal (31) .

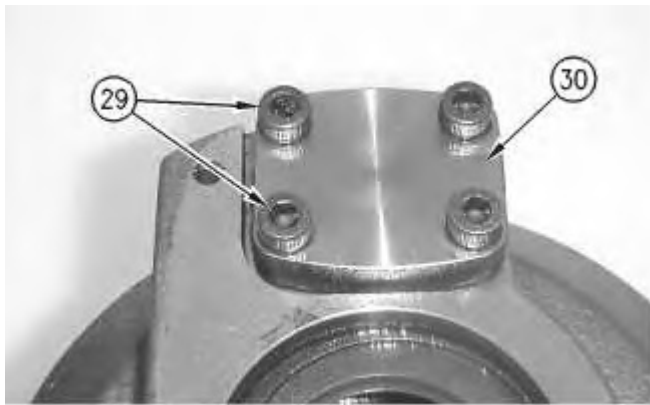

Illustration 4

g00887619

4. Install cover (30) and bolts (29) . Tighten bolts (29) to a torque of  $28 \pm 7 \text{ N}\cdot\text{m}$  ( $21 \pm 5 \text{ lb ft}$ ).



Illustration 5

g00887589

5. Apply Tooling (G) to the mating surface of seal (28) . Use Tooling (E) in order to install seal (28) .
6. Use Tooling (F) in order to install retaining ring (27) .

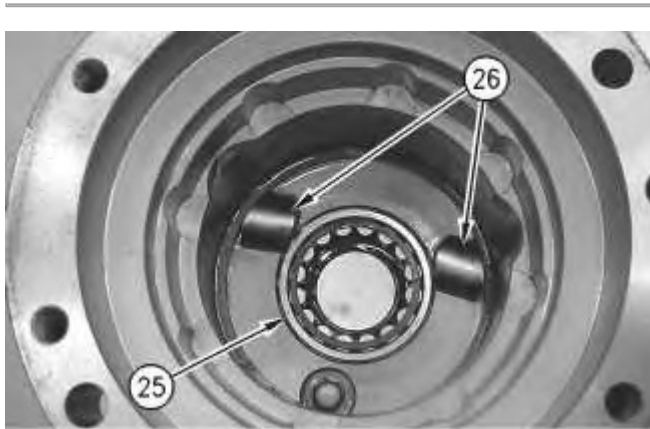

Illustration 6

g00887578

7. Rotate the housing.
8. Install keys (26) and locating pins (not shown) into the body of the travel motor.
9. Install bearing (25) .



Illustration 7

g00887558

 **WARNING**

**Improper assembly of parts that are spring loaded can cause bodily injury.**

**To prevent possible injury, follow the established assembly procedure and wear protective equipment.**

---

10. Install springs (24) into the barrel. Install ball (23) onto springs (24) .

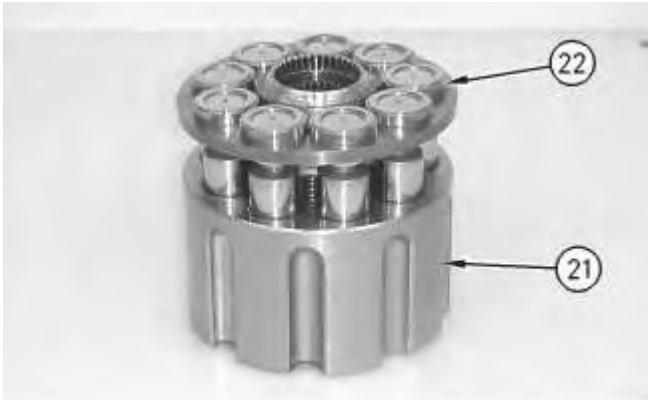

Illustration 8

g00887520

11. Install piston assemblies and retainer plate (22) into barrel assembly (21) .

**Note:** Take note of the mark on the piston assembly and the barrel assembly. The pistons must be returned to the same position.



Illustration 9

g00887501

12. Install cam plate (20) onto barrel assembly (21) .

---

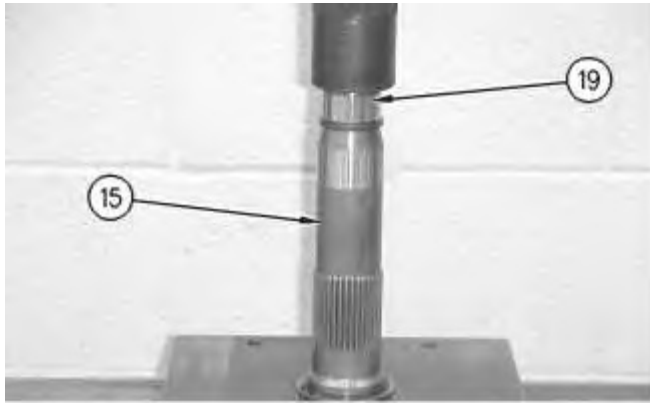

Illustration 10

g00888697

13. Install shaft (15) into a suitable press. Install bearing race (19) onto shaft (15) .

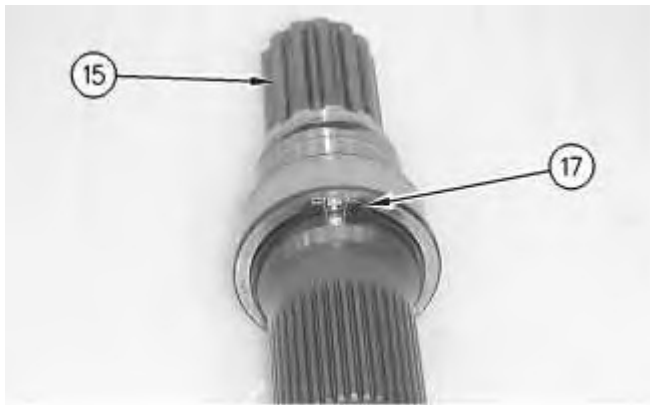

Illustration 11

g00887426

14. Rotate shaft (15) in the suitable press. Use Tooling (D) to install retaining ring (17) onto shaft (15) .

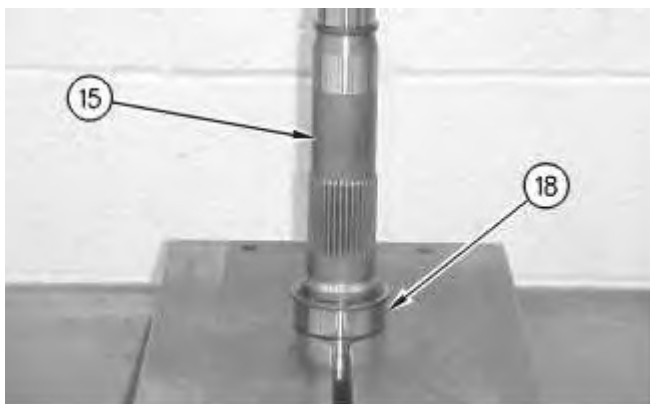

Illustration 12

g00888710

15. Install bearing race (18) onto shaft (15) .

**Note:** Bearing race (18) must contact retaining ring (17) .

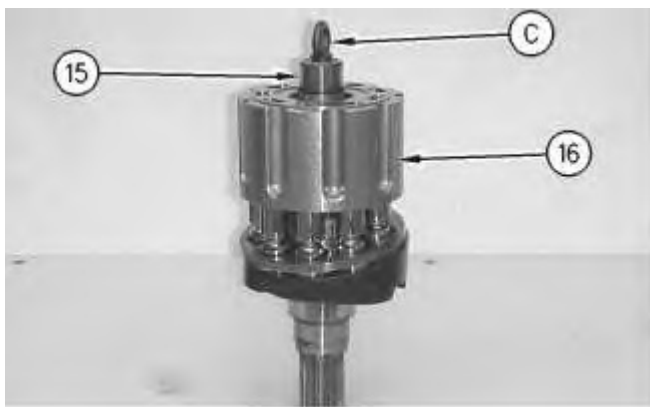

Illustration 13

g00887405

16. Install Tooling (C) into shaft (15) . Install shaft (15) into rotating assembly (16) .

17. Place the pump housing into Tooling (A) .

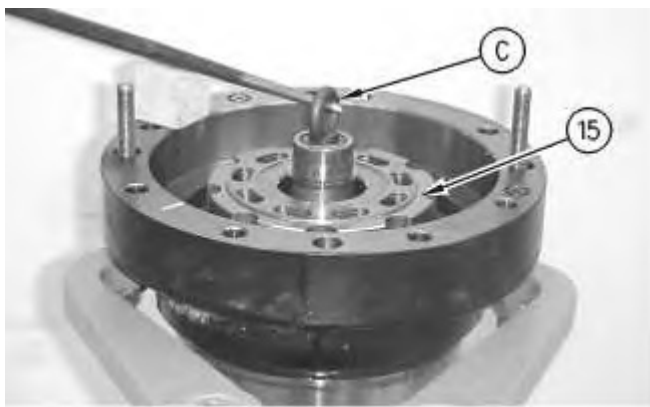

Illustration 14

g00887401

18. Use Tooling (C) in order to install rotating assembly (16) into the housing.

---



Illustration 15

g00887501

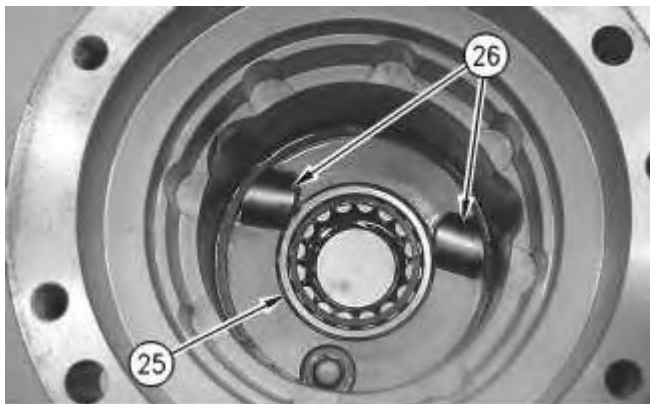

Illustration 16

g00887578

19. The notches in cam plate (20) must align with keys (26) . The keys are located in the bottom of the housing of the travel motor.



Illustration 17

g00887355

20. Install plates (13) and friction discs (14) into the housing.

**Note:** Install the plates and the discs alternately.



Illustration 18

g00887336

21. Install backup ring (12) and seal (11) onto the brake piston.
22. Install backup ring (10) and seal (9) onto the brake piston.

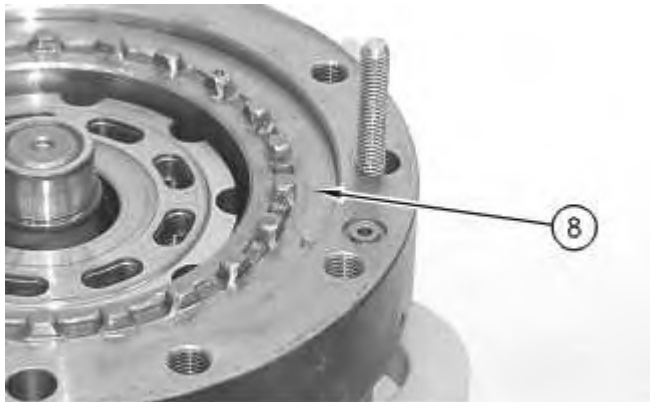

Illustration 19

g00888967

23. Rotate brake piston (8) .
24. Install brake piston (8) into the housing.

**Note:** Brake piston (8) must be level upon installation. The brake piston must be level in order to prevent damage to the O-ring seals.

---

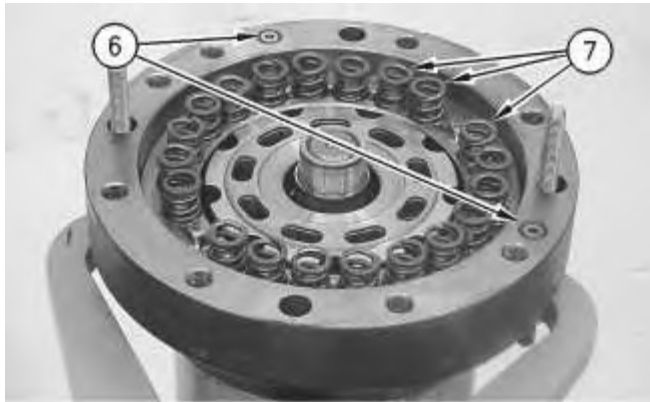

Illustration 20

g00887311

25. Install springs (7) and O-ring seals (6) .

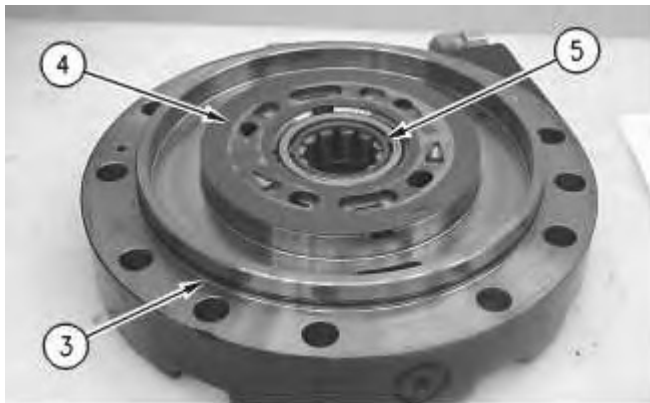

Illustration 21

g00887302

26. Install O-ring seal (3) , port plate (4) , and bearing (5) .



Illustration 22

g00887295

27. Install head (2) onto the body of the travel motor.

**Note:** During the installation of head (2) onto the travel motor, be careful not to damage the mating surfaces of the components.

28. Install bolts (1) . Tighten bolts (1) to a torque of  $240 \pm 40$  N·m ( $177 \pm 30$  lb ft).

**End By:** Install the travel motor. Refer to Disassembly and Assembly, "Travel Motor - Install" .

Previous Screen

Product: EXCAVATOR

Model: 330C EXCAVATOR JCD

Configuration: 330C & 330C L Excavators JCD00001-UP (MACHINE) POWERED BY C-9 Engine

## Disassembly and Assembly 330C Excavator Machine Systems

Media Number -REN5438-14

Publication Date -01/04/2010

Date Updated -13/04/2010

i02372696

# Travel Motor - Install

SMCS - 4351-012

## Installation Procedure

Table 1

Required Tools			
Tool	Part Number	Part Description	Qty
A		Threaded Rod	2

---

### NOTICE

**Care must be taken to ensure that fluids are contained during performance of inspection, maintenance, testing, adjusting and repair of the product. Be prepared to collect the fluid with suitable containers before opening any compartment or disassembling any component containing fluids.**

**Refer to Special Publication, NENG2500, "Caterpillar Dealer Service Tool Catalog" for tools and supplies suitable to collect and contain fluids on Caterpillar products.**

**Dispose of all fluids according to local regulations and mandates.**

---

1. Thoroughly clean the mating surfaces of the travel motor and the final drive.
-



Illustration 1

g00878123

2. Install new O-ring seal (5) . Apply clean hydraulic oil on the O-ring seal.

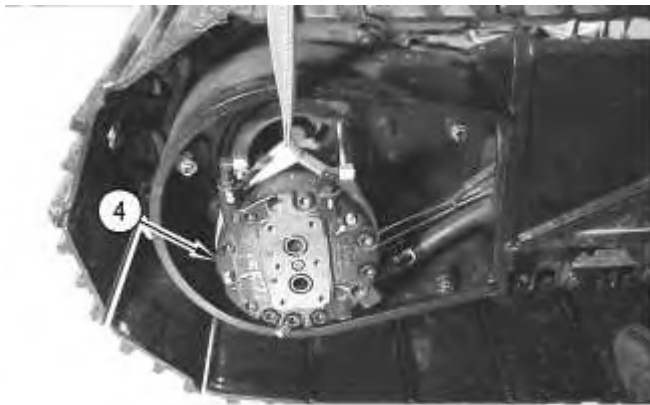

Illustration 2

g00707267

3. Fasten a suitable lifting device to travel motor (4) , as shown. The weight of travel motor (4) is approximately 57 kg (125 lb).

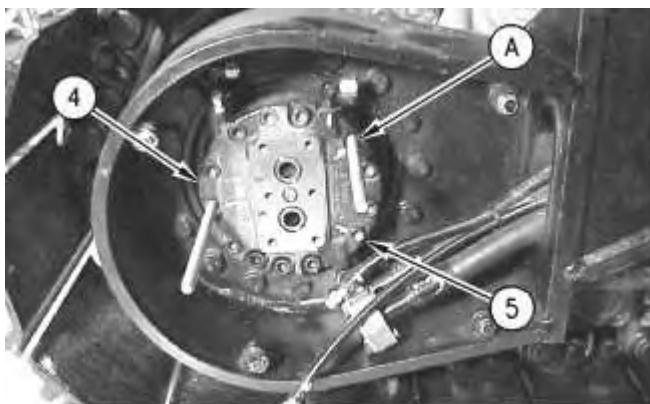

Illustration 3

g00878121



**Suggest:**

**If the above button click is invalid.**

**Please download this document first, and then click the above link to download the complete manual.**

**Thank you so much for reading**

4. Carefully install travel motor (4) on Tooling (A) . Slide the travel motor into the final drive.
5. Install one of three bolts (5) that secures the travel motor to the final drive.
6. Remove Tooling (A) .

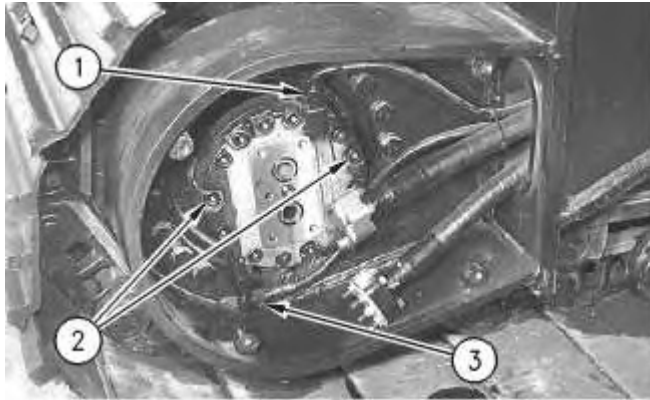

Illustration 4

g00707275

7. Install two remaining bolts (2) .
8. Connect hose assemblies (3) and (1) .
9. Fill the final drive with oil.

**Reference:** Refer to Operation and Maintenance Manual, "Lubricant Viscosities" for the proper oil viscosity.

**Reference:** Refer to Operation and Maintenance Manual, "Final Drive Oil Level - Check" for the correct filling procedure.

10. Install high efficiency filters in place of the pilot filter, the case drain filter, and the return filter.

**Note:** High efficiency filters should not be run for more than 250 hours before you change back to the standard filters.

**End By:** Install the travel brake valve. Refer to Disassembly and Assembly, "Counterbalance Valve (Travel) - Install".

**<https://www.ebooklibonline.com>**

Hello dear friend!

Thank you very much for reading.

Enter the link into your browser.

The full manual is available for immediate download.

**<https://www.ebooklibonline.com>**