

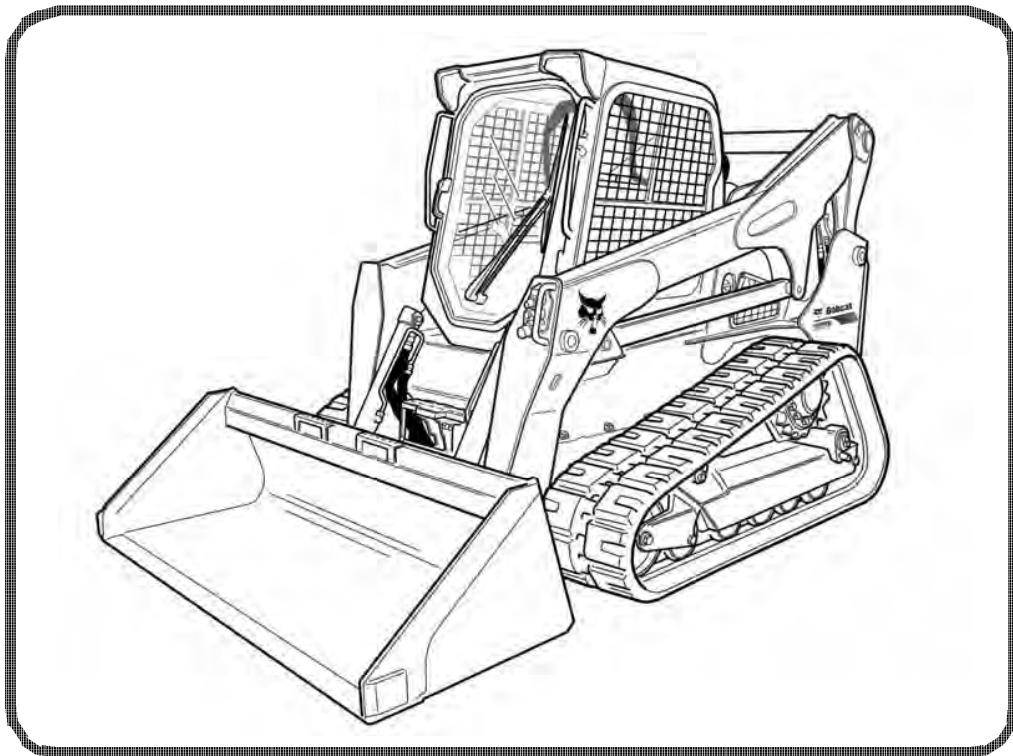

Service Manual

T870 Compact Track Loader

S/N B47C11001 & Above
S/N B47L11001 & Above



**EQUIPPED WITH
BOBCAT INTERLOCK
CONTROL SYSTEM (BICS™)**



MAINTENANCE SAFETY



WARNING

Instructions are necessary before operating or servicing machine. Read and understand the Operation & Maintenance Manual, Operator's Handbook and signs (decals) on machine. Follow warnings and instructions in the manuals when making repairs, adjustments or servicing. Check for correct function after adjustments, repairs or service. Untrained operators and failure to follow instructions can cause injury or death.

W-2003-0807



Safety Alert Symbol: This symbol with a warning statement, means: "Warning, be alert! Your safety is involved!" Carefully read the message that follows.

CORRECT

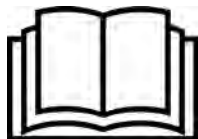

P-90216

- Never service the Bobcat Skid-Steer Loader without instructions.

CORRECT

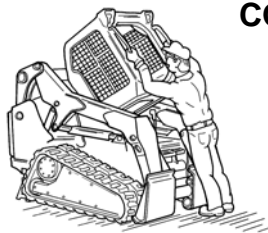

NA1711

- Use the correct procedure to lift or lower operator cab.

CORRECT

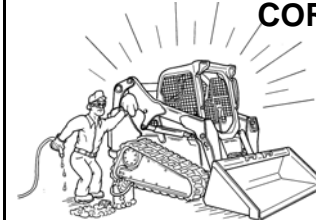

NA1715

- Cleaning and maintenance are required daily.

WRONG



NA1714

- Have good ventilation when welding or grinding painted parts.
- Wear dust mask when grinding painted parts. Toxic dust and gas can be produced.
- Avoid exhaust fume leaks which can kill without warning. Exhaust system must be tightly sealed.

WRONG



NA1710

- Disconnecting or loosening any hydraulic tubeline, hose, fitting, component or a part failure can cause lift arms to drop. Do not go under lift arms when raised unless supported by an approved lift arm support device. Replace it if damaged.

WRONG

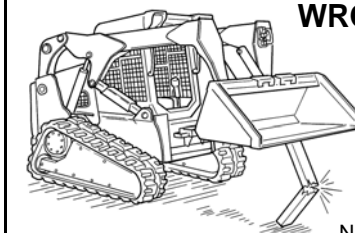

NA1712

- Never work on loader with lift arms up unless lift arms are held by an approved lift arm support device. Replace if damaged.
- Never modify equipment or add attachments not approved by Bobcat Company.

WRONG



NA1722

- Stop, cool and clean engine of flammable materials before checking fluids.
- Never service or adjust loader with the engine running unless instructed to do so in the manual.
- Avoid contact with leaking hydraulic fluid or diesel fuel under pressure. It can penetrate the skin or eyes.
- Never fill fuel tank with engine running, while smoking or when near open flame.

WRONG

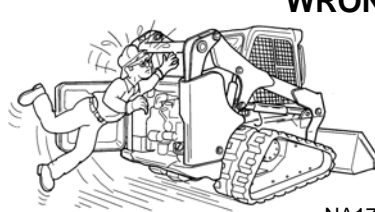

NA1725

- Keep body, jewelry and clothing away from moving parts, electrical contact, hot parts and exhaust.
- Wear eye protection to guard from battery acid, compressed springs, fluids under pressure and flying debris when engines are running or tools are used. Use eye protection approved for type of welding.
- Keep rear door closed except for service. Close and latch door before operating the loader.

WRONG



B-6589

- Lead-acid batteries produce flammable and explosive gases.
- Keep arcs, sparks, flames and lighted tobacco away from batteries.
- Batteries contain acid which burns eyes or skin on contact.
- Wear protective clothing. If acid contacts body, flush well with water. For eye contact flush well and get immediate medical attention.

Maintenance procedures which are given in the Operation & Maintenance Manual can be performed by the owner/operator without any specific technical training. Maintenance procedures which are **not** in the Operation & Maintenance Manual must be performed **ONLY BY QUALIFIED BOBCAT SERVICE PERSONNEL**. Always use genuine Bobcat replacement parts. The Service Safety Training Course is available from your Bobcat dealer.

MSW40-0609

Dealer Copy -- Not for Resale

CONTENTS

SAFETY AND MAINTENANCE	10-01
HYDRAULIC SYSTEM	20-01
HYDROSTATIC SYSTEM	30-01
DRIVE SYSTEM	40-01
MAINFRAME	50-01
ELECTRICAL SYSTEM AND ANALYSIS	60-01
ENGINE SERVICE	70-01
HEATING, VENTILATION AND AIR CONDITIONING (HVAC)	80-01
SPECIFICATIONS	SPEC-01
ALPHABETICAL INDEX	INDEX-01

Dealer Copy -- Not for Resale

<https://www.ebooklibonline.com>

Hello dear friend!

Thank you very much for reading.

Enter the link into your browser.

The full manual is available for immediate download.

<https://www.ebooklibonline.com>

FOREWORD







FOREWORD	1-7
SAFETY INSTRUCTIONS	1-9
FIRE PREVENTION	1-11
Maintenance	1-11
Operation	1-11
Electrical	1-11
Hydraulic System	1-11
Fueling	1-11
Starting	1-11
Spark Arrester Exhaust System	1-11
Welding And Grinding	1-12
Fire Extinguishers	1-12
SERIAL NUMBER LOCATIONS	1-13
Loader Serial Number	1-13
Engine Serial Number	1-13
DELIVERY REPORT	1-13
LOADER IDENTIFICATION	1-14

Dealer Copy -- Not for Resale

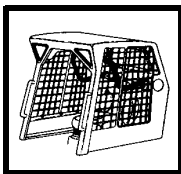
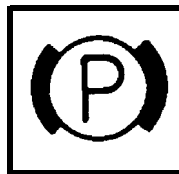
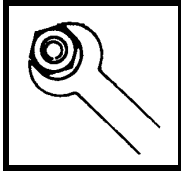
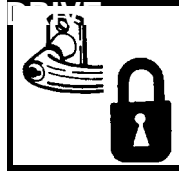
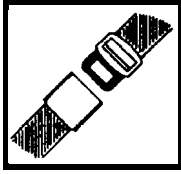
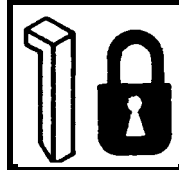
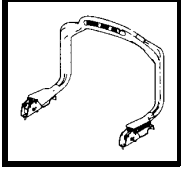
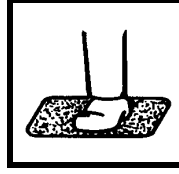
FOREWORD

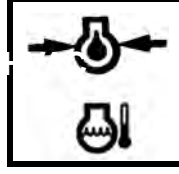
This manual is for the Bobcat loader mechanic. It provides necessary servicing and adjustment procedures for the Bobcat loader and its component parts and systems. Refer to the Operation & Maintenance Manual for operating instructions, starting procedure, daily checks, etc.

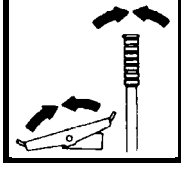
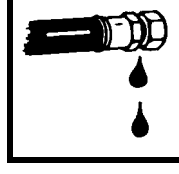
A general inspection of the following items must be made after the loader has had service or repair:

- | | | | |
|--|---|---|---|
| 1. Check that the ROPS/FOPS (Including side screens) is in good condition and is not modified. |  | 9. The parking brake must function correctly. |  |
| 2. Check that ROPS mounting hardware is tightened and is Bobcat approved. |  | 10. Enclosure door latches must open and close freely. |  |
| 3. The seat belt must be correctly installed, functional and in good condition. |  | 11. Bob-Tach® wedges and linkages must function correctly and be in good condition. |  |
| 4. The seat bar must be correctly adjusted, clean and lubricated. |  | 12. Safety treads must be in good condition. |  |
| 5. Check lift arm support device, replace if damaged. |  | 13. Check for correct function of indicator lamps. |  |
| 6. Machine signs (decals) must be legible and in the correct location. |  | 14. Check all machine fluid levels. |  |
| 7. Steering levers, hand controls and foot pedals must return to neutral (as applicable). |  | 15. Inspect for fuel, oil or hydraulic fluid leaks. |  |
| 8. Check for correct function of the work lights. |  | 16. Lubricate the loader. |  |

Dealer Copy -- Not for Resale

FW SSL-0617 SM

17. Check the condition of the battery and cables.

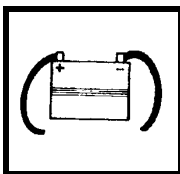

18. Inspect the air cleaner for damage or leaks. Check the condition of the element.

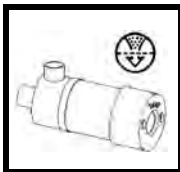

19. Check the electrical charging system.

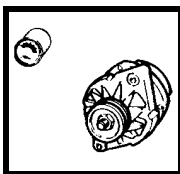

20. Check tires for wear and pressure. Check tracks for wear and tension. Use only approved tires or tracks.



21. Inspect for loose or broken parts or connections.

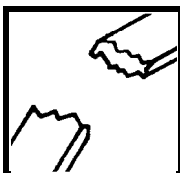

22. Check for any field modification not completed.



23. Operate the machine and check all functions.



24. Check for correct function of the Bobcat Interlock Control System (BICS™) before the machine is returned to the customer.



25. Check for proper function of front horn and back-up alarm (if equipped).

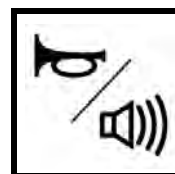

26. Check function or condition of all equipped options and accessories (examples: fire extinguisher, rotating beacon, lift kits, etc.).



27. Recommend to the owner that all necessary corrections be made before the machine is returned to service.

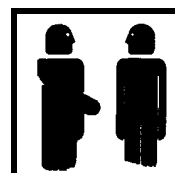

**CALIFORNIA
PROPOSITION 65 WARNING**
Diesel engine exhaust and some of its constituents are known to the state of California to cause cancer, birth defects and other reproductive harm.

SAFETY INSTRUCTIONS



Safety Alert Symbol

This symbol with a warning statement means: "Warning, be alert! Your safety is involved!" Carefully read the message that follows.



WARNING

AVOID INJURY OR DEATH

Instructions are necessary before operating or servicing machine. Read and understand the Operation & Maintenance Manual, Operator's Handbook and signs (decals) on machine. Follow warnings and instructions in the manuals when making repairs, adjustments or servicing. Check for correct function after adjustments, repairs or service. Untrained operators and failure to follow instructions can cause injury or death.

W-2003-0807

IMPORTANT

This notice identifies procedures which must be followed to avoid damage to the machine.

I-2019-0284



DANGER

The signal word DANGER on the machine and in the manuals indicates a hazardous situation which, if not avoided, will result in death or serious injury.

D-1002-1107



WARNING

The signal word WARNING on the machine and in the manuals indicates a potentially hazardous situation which, if not avoided, could result in death or serious injury.

W-2044-1107

The following publications provide information on the safe use and maintenance of the Bobcat machine and attachments:

- The Delivery Report is used to assure that complete instructions have been given to the new owner and that the machine is in safe operating condition.
- The Operation & Maintenance Manual delivered with the machine or attachment contains operating information as well as routine maintenance and service procedures. It is a part of the machine and can be stored in a container provided on the machine. Replacement Operation & Maintenance Manuals can be ordered from your Bobcat dealer.
- Machine signs (decals) instruct on the safe operation and care of your Bobcat machine or attachment. The signs and their locations are shown in the Operation & Maintenance Manual. Replacement signs are available from your Bobcat dealer.
- An Operator's Handbook fastened to the operator cab. It's brief instructions are convenient to the operator. The handbook is available from your dealer in an English edition or one of many other languages. See your Bobcat dealer for more information on translated versions.
- The AEM Safety Manual delivered with the machine gives general safety information.
- The Service Manual and Parts Manual are available from your dealer for use by mechanics to do shop-type service and repair work.
- The Skid-Steer Loader Operator Training Course is available through your local dealer or at bobcat.com/training or bobcat.com. This course is intended to provide rules and practices of correct operation of the skid-steer loader. The course is available in English and Spanish versions.
- Service Safety Training Courses are available from your Bobcat dealer or at bobcat.com/training or bobcat.com. They provide information for safe and correct service procedures.
- The Skid-Steer Loader Safety Video is available from your Bobcat dealer or at bobcat.com/training or bobcat.com.

Dealer Copy -- Not for Resale

SI SSL-1016 SM

FIRE PREVENTION



Maintenance

The machine and some attachments have components that are at high temperatures under normal operating conditions. The primary source of high temperatures is the engine and exhaust system. The electrical system, if damaged or incorrectly maintained, can be a source of arcs or sparks.

Flammable debris (leaves, straw, etc.) must be removed regularly. If flammable debris is allowed to accumulate, it can cause a fire hazard. Clean often to avoid this accumulation. Flammable debris in the engine compartment is a potential fire hazard.

The operator's area, engine compartment and engine cooling system must be inspected every day and cleaned if necessary to prevent fire hazards and overheating.

All fuels, most lubricants and some coolants mixtures are flammable. Flammable fluids that are leaking or spilled onto hot surfaces or onto electrical components can cause a fire.

Operation

Do not use the machine where exhaust, arcs, sparks or hot components can contact flammable material, explosive dust or gases.

Electrical



Check all electrical wiring and connections for damage. Keep the battery terminals clean and tight. Repair or replace any damaged part or wires that are loose or frayed.

Battery gas can explode and cause serious injury. Use the procedure in the Operation & Maintenance Manual for connecting the battery and for jump starting. Do not jump start or charge a frozen or damaged battery. Keep any open flames or sparks away from batteries. Do not smoke in battery charging area.

Hydraulic System

Check hydraulic tubes, hoses and fittings for damage and leakage. Never use open flame or bare skin to check for leaks. Hydraulic tubes and hoses must be properly routed and have adequate support and secure clamps. Tighten or replace any parts that show leakage.

Always clean fluid spills. Do not use gasoline or diesel fuel for cleaning parts. Use commercial nonflammable solvents.

Fueling



Stop the engine and let it cool before adding fuel. No smoking! Do not refuel a machine near open flames or sparks. Fill the fuel tank outdoors.

Ultra Low Sulfur Diesel (ULSD) poses a greater static ignition hazard than earlier diesel formulations with higher Sulfur content. Avoid death or serious injury from fire or explosion. Consult with your fuel or fuel system supplier to ensure the delivery system is in compliance with fueling standards for proper grounding and bonding practices.

Starting

Do not use ether or starting fluids on any engine that has glow plugs or air intake heater. These starting aids can cause explosion and injure you or bystanders.

Use the procedure in the Operation & Maintenance Manual for connecting the battery and for jump starting.

Spark Arrester Exhaust System

The spark arrester exhaust system is designed to control the emission of hot particles from the engine and exhaust system, but the muffler and the exhaust gases are still hot.

Check the spark arrester exhaust system regularly to make sure it is maintained and working properly. Use the procedure in the Operation & Maintenance Manual for cleaning the spark arrester muffler (if equipped).

Dealer Copy -- Not for Resale

FIRE PREVENTION (CONT'D)

Welding And Grinding

Always clean the machine and attachment, disconnect the battery, and disconnect the wiring from the Bobcat controllers before welding. Cover rubber hoses, battery and all other flammable parts. Keep a fire extinguisher near the machine when welding.

Have good ventilation when grinding or welding painted parts. Wear dust mask when grinding painted parts. Toxic dust or gas can be produced.

Dust generated from repairing nonmetallic parts such as hoods, fenders or covers can be flammable or explosive. Repair such components in a well ventilated area away from open flames or sparks.

Fire Extinguishers

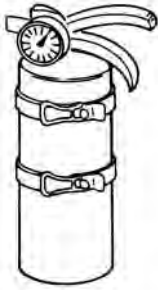

Know where fire extinguishers and first aid kits are located and how to use them. Inspect the fire extinguisher and service the fire extinguisher regularly. Obey the recommendations on the instructions plate.

SERIAL NUMBER LOCATIONS

Always use the serial number of the loader when requesting service information or when ordering parts. Earlier or later models (identification made by serial number) may use different parts, or there may be different procedures to follow when performing a specific service operation.

Loader Serial Number

Figure 1

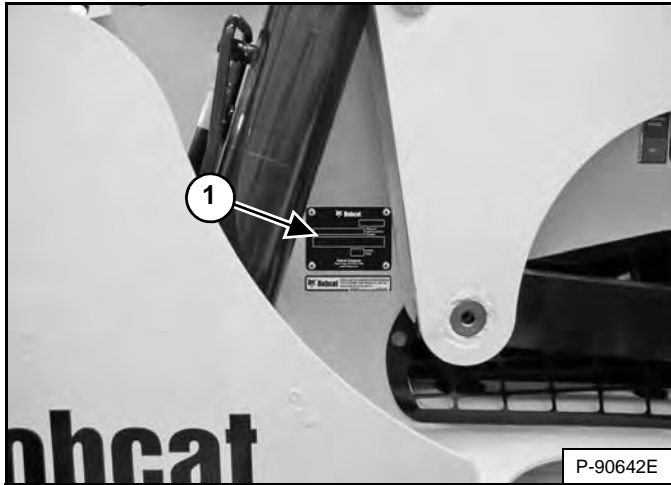

The loader serial number plate (Item 1) [Figure 1] is located on the outside of the loader frame.

Engine Serial Number

Figure 2

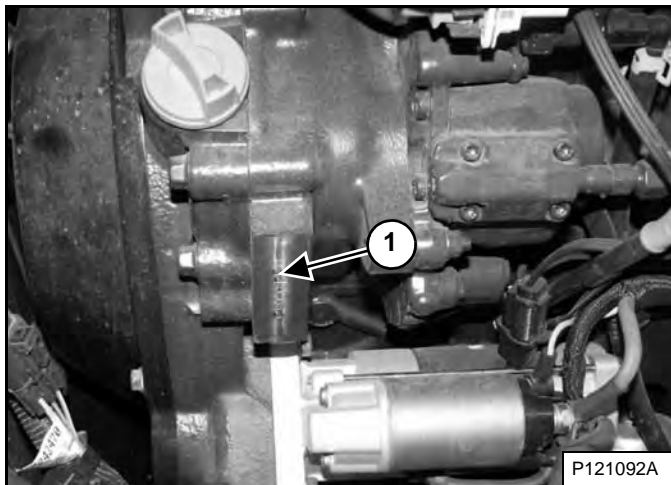

The engine serial number (Item 1) [Figure 2] is located on the side of the engine above the oil filter.

DELIVERY REPORT

Figure 3



The delivery report [Figure 3] contains a list of items that must be explained or shown to the owner or operator by the dealer when the Bobcat loader is delivered.

The delivery report must be reviewed and signed by the owner or operator and the dealer.

Dealer Copy -- Not for Resale

LOADER IDENTIFICATION

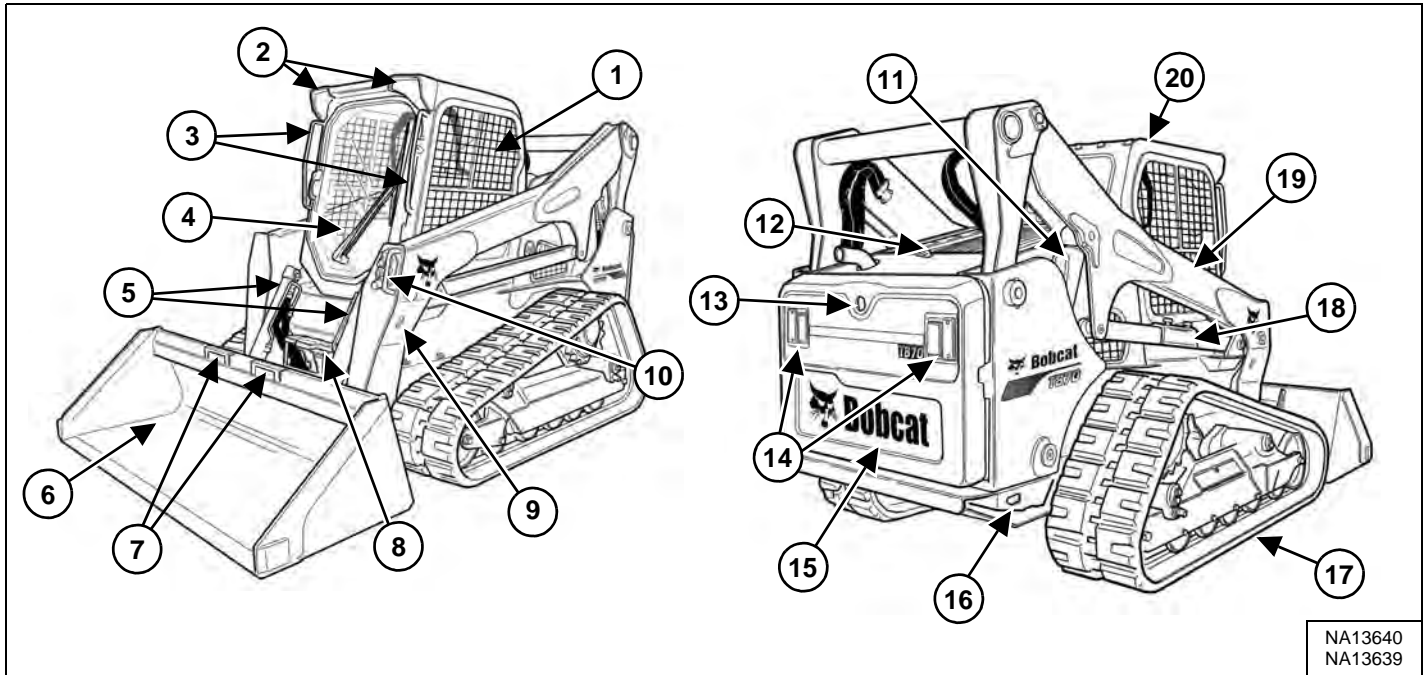

ITEM	DESCRIPTION	ITEM	DESCRIPTION
1	Operation & Maintenance Manual and Operator's Handbook	11	Lift Cylinder (Both Sides)
2	Front Lights	12	Rear Grille
3	Grab Handles	13	Back-up Alarm
4	Operator Seat with Seat Belt and Seat Bar	14	Rear Work Lights and Taillights
5	Tilt Cylinders	15	Rear Door
6	Bucket [A]	16	Rear Tie-down (Both Sides) Front Tie-downs located behind Bucket
7	Bucket Steps	17	Track
8	Step	18	Lift Arm Support Device
9	Alternate Front Tie-down (Both Sides)	19	Lift Arm
10	Front Auxiliary Quick Couplers	20	Operator Cab (ROPS and FOPS) [B]

[A] Bucket – Several different buckets and other attachments are available for the Bobcat loader.

[B] ROPS – Roll-Over Protective Structure per ISO 3471 and FOPS – Falling-Object Protective Structure per ISO 3449, Level I. Level II is available.

Dealer Copy -- Not for Resale

SAFETY AND MAINTENANCE

LIFTING AND BLOCKING THE LOADER	10-10-1
Procedure	10-10-1
LIFT ARM SUPPORT DEVICE	10-20-1
Description	10-20-1
Installing	10-20-2
Removing	10-20-3
OPERATOR CAB	10-30-1
Description	10-30-1
Raising	10-30-1
Lowering	10-30-2
Cab Door Sensor	10-30-3
Special Applications Kit	10-30-4
Special Applications Kit Inspection And Maintenance	10-30-4
Forestry Door And Window Kit	10-30-5
Forestry Door And Window Kit Inspection And Maintenance	10-30-5
TRANSPORTING THE LOADER ON A TRAILER	10-40-1
Loading And Unloading	10-40-1
Fastening	10-40-1
TOWING THE LOADER	10-50-1
Procedure	10-50-1
REMOTE START TOOL KIT-MEL1563	10-60-1
Remote Start Tool - MEL1563	10-60-1
Service Tool Harness Communicator - MEL1566	10-60-3
Remote Start Procedure	10-60-3
REMOTE START TOOL (SERVICE TOOL) KIT - 7217666	10-61-1
Description	10-61-1
Remote Start Tool (Service Tool) - 7022042	10-61-2
Loader Service Tool Harness - 6689747	10-61-3
Computer Service Tool Harness - 6689746	10-61-4
Remote Start Procedure	10-61-5
SERVICE SCHEDULE	10-70-1
Maintenance Intervals	10-70-1
ENGINE AIR CLEANER	10-80-1
Replacing Filter Elements	10-80-1
ENGINE COOLING SYSTEM	10-90-1
Maintenance Platform	10-90-1
Cleaning	10-90-1
Checking And Adding Coolant	10-90-4
Removing And Replacing Coolant	10-90-5

Dealer Copy -- Not for Resale

FUEL SYSTEM	10-100-1
Fuel Specifications	10-100-1
Biodiesel Blend Fuel	10-100-1
Filling The Fuel Tank	10-100-2
Fuel Filter	10-100-3
Removing Air From The Fuel System	10-100-4
ENGINE LUBRICATION SYSTEM	10-110-1
Checking And Adding Engine Oil	10-110-1
Engine Oil Chart	10-110-1
Removing And Replacing Oil And Filter	10-110-2
HYDRAULIC / HYDROSTATIC SYSTEM	10-120-1
Checking And Adding Fluid	10-120-1
Hydraulic / Hydrostatic Fluid Chart	10-120-1
Removing And Replacing Hydraulic Fluid	10-120-2
Removing And Replacing Hydraulic / Hydrostatic Filter	10-120-4
Removing And Replacing Hydraulic Charge Filter	10-120-5
Replacing Reservoir Breather Cap	10-120-6
BOB-TACH (HAND LEVER)	10-130-1
Inspection And Maintenance	10-130-1
BOB-TACH (POWER)	10-131-1
Inspection And Maintenance	10-131-1
LUBRICATING THE LOADER	10-140-1
Lubrication Locations	10-140-1
PIVOT PINS	10-150-1
Inspection And Maintenance	10-150-1
LOADER STORAGE AND RETURN TO SERVICE	10-160-1
Storage	10-160-1
Return To Service	10-160-1
STOPPING THE ENGINE AND LEAVING THE LOADER	10-170-1
Procedure	10-170-1
EMERGENCY EXIT	10-180-1
Rear Window Identification	10-180-1
Rear Window Removal (Latches)	10-180-1
Rear Window Removal (Rubber Cord)	10-180-2
External Access (Rear Window With Latches)	10-180-2
External Access (Rear Window With Rubber Cord)	10-180-3
Front Door	10-180-3
SEAT BELT	10-190-1
Inspection And Maintenance	10-190-1

LIFTING AND BLOCKING THE LOADER

Procedure

Figure 10-10-1

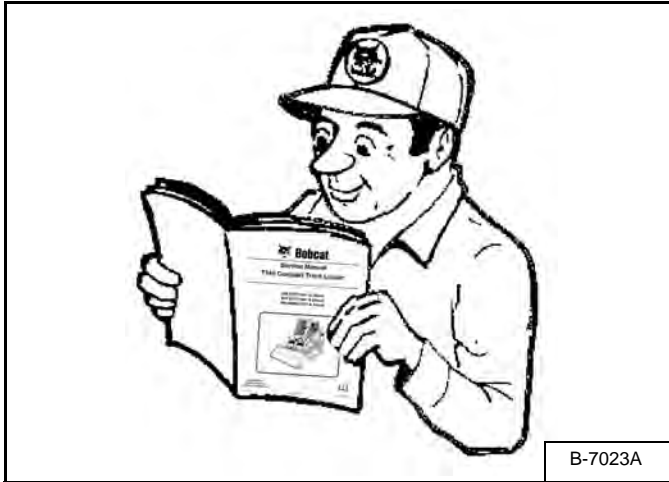

WARNING

AVOID INJURY OR DEATH

Instructions are necessary before operating or servicing machine. Read and understand the Operation & Maintenance Manual, Operator's Handbook and signs (decals) on machine. Follow warnings and instructions in the manuals when making repairs, adjustments or servicing. Check for correct function after adjustments, repairs or service. Untrained operators and failure to follow instructions can cause injury or death.

W-2003-0807

Read the Removal and Installation, Disassembly and Assembly, etc. completely to become familiar with the procedure before beginning [Figure 10-10-1].

Always park the loader on a level surface.

WARNING

MACHINE FALLING OR MOVING CAN CAUSE SERIOUS INJURY OR DEATH

Put jackstands under the front and rear of the machine before running engine for service.

W-2718-0208

Figure 10-10-2

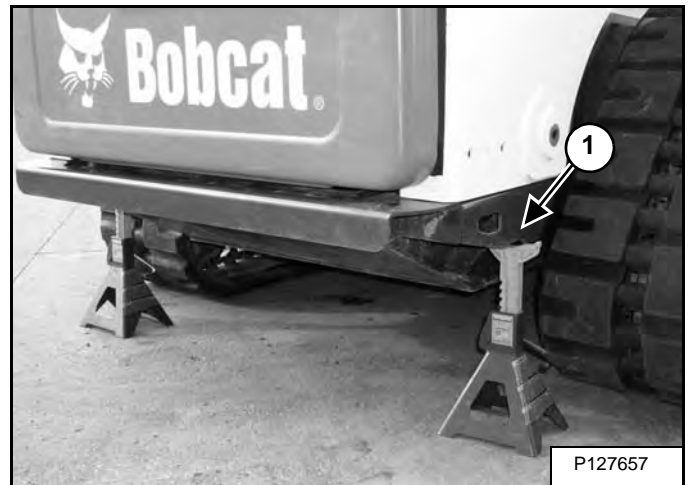

Lift the rear of the loader and install jackstands in the notched area of the frame (Item 1) [Figure 10-10-2].

Figure 10-10-3

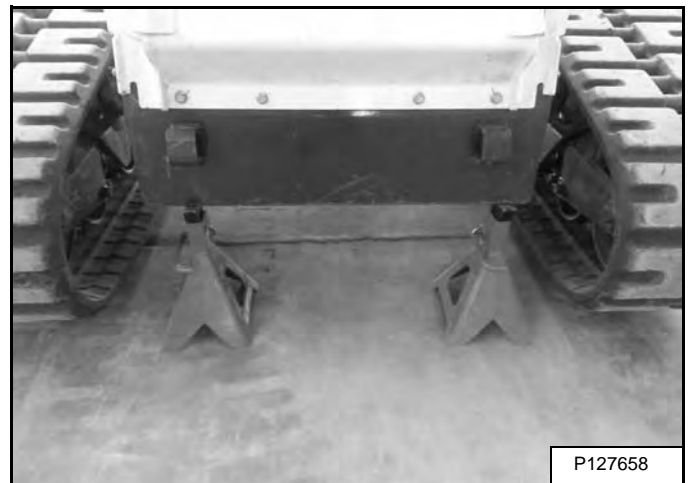

Lift the front of the loader and install jackstands under the front edge of the loader [Figure 10-10-3].

NOTE: Make sure the jackstands do not touch the tracks. Make sure the tracks clear the floor or any obstacles.

NOTE: The lift arms are raised for photo clarity.

Dealer Copy -- Not for Resale

LIFT ARM SUPPORT DEVICE

Description

! WARNING

Never work on a machine with the lift arms up unless the lift arms are secured by an approved lift arm support device. Failure to use an approved lift arm support device can allow the lift arms or attachment to fall and cause injury or death.

Service lift arm support device if damaged or if parts are missing. Using a damaged lift arm support or with missing parts can cause lift arms to drop causing injury or death.

W-2572-0407

Figure 10-20-1

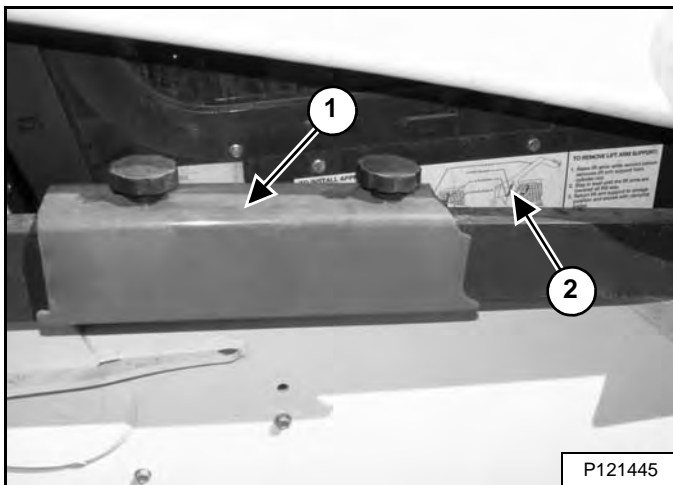

The lift arm support device (Item 1) [Figure 10-20-1] is used to support the lift arms while working on a machine with the lift arms up.

A decal (Item 2) [Figure 10-20-1] located on the right side of the operator cab provides instructions for installing and removing the lift arm support device.

The procedures are described in more detail on the following pages. (See Installing on Page 10-20-2.) and (See Removing on Page 10-20-3.)

LIFT ARM SUPPORT DEVICE (CONT'D)

Installing



P-90328

AVOID DEATH

- Disconnecting or loosening any hydraulic tubeline, hose, fitting, component or a part failure can cause lift arms to drop.
- Keep out of this area when lift arms are raised unless supported by an approved lift arm support. Replace if damaged.

D-1009-0409

Remove attachment from the loader. (See Operation And Maintenance Manual.)

Figure 10-20-2

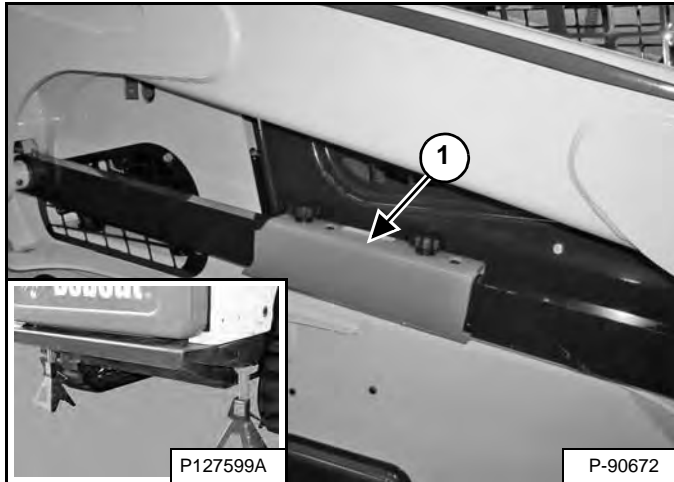

Put jackstands under the rear corners of the loader frame (Inset) [Figure 10-20-2].

Remove the lift arm support device (Item 1) [Figure 10-20-2] from the storage position.

The operator must stay in the operator seat with the seat belt fastened and the seat bar lowered until the lift arm support device is installed.

Start the engine and raise the lift arms all the way up.

Figure 10-20-3



P-90677

Have a second person install the lift arm support device over the rod of one of the lift cylinders [Figure 10-20-3].

The lift arm support device must be tight against the cylinder rod.

Figure 10-20-4



P100399

P-90640A

Lower the lift arms slowly until the lift arm support device is held between the lift arms and the lift cylinder. The tabs of the lift arm support device must go past the end of the cylinder (Inset) [Figure 10-20-4].



Suggest:

If the above button click is invalid.

Please download this document

first, and then click the above link

to download the complete manual.

Thank you so much for reading

LIFT ARM SUPPORT DEVICE (CONT'D)

Removing

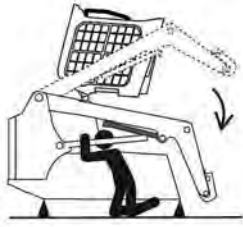

P-90328

AVOID DEATH

- **Disconnecting or loosening any hydraulic tubeline, hose, fitting, component or a part failure can cause lift arms to drop.**
- **Keep out of this area when lift arms are raised unless supported by an approved lift arm support. Replace if damaged.**

D-1009-0409

The operator must be in the operator's seat, with the seat belt fastened and seat bar lowered, until the lift arm support device is removed, and the lift arms are lowered all the way.

NOTE: The lift arm support device should remain resting on the cylinder barrel when the lift arms are raised. Service or replace the lift arm support device if the lift arm support raised with the cylinder rod.

Start the engine and raise the lift arms all the way up.

Figure 10-20-5



Have a second person remove the lift arm support device [Figure 10-20-5] after the lift arms are all the way up.

Lower the lift arms all the way and stop the engine.

Figure 10-20-6



Return the lift arm support device to the storage position and secure with the clamping knobs [Figure 10-20-6].

Remove the jackstands.

Dealer Copy -- Not for Resale

<https://www.ebooklibonline.com>

Hello dear friend!

Thank you very much for reading.

Enter the link into your browser.

The full manual is available for immediate download.

<https://www.ebooklibonline.com>