



Bobcat®

Service Manual

TL360(X) Telescopic Handler

S/N AN6H11001 & Above
S/N ANFU11001 & Above
S/N AVM911001 & Above
S/N AVMD11001 & Above

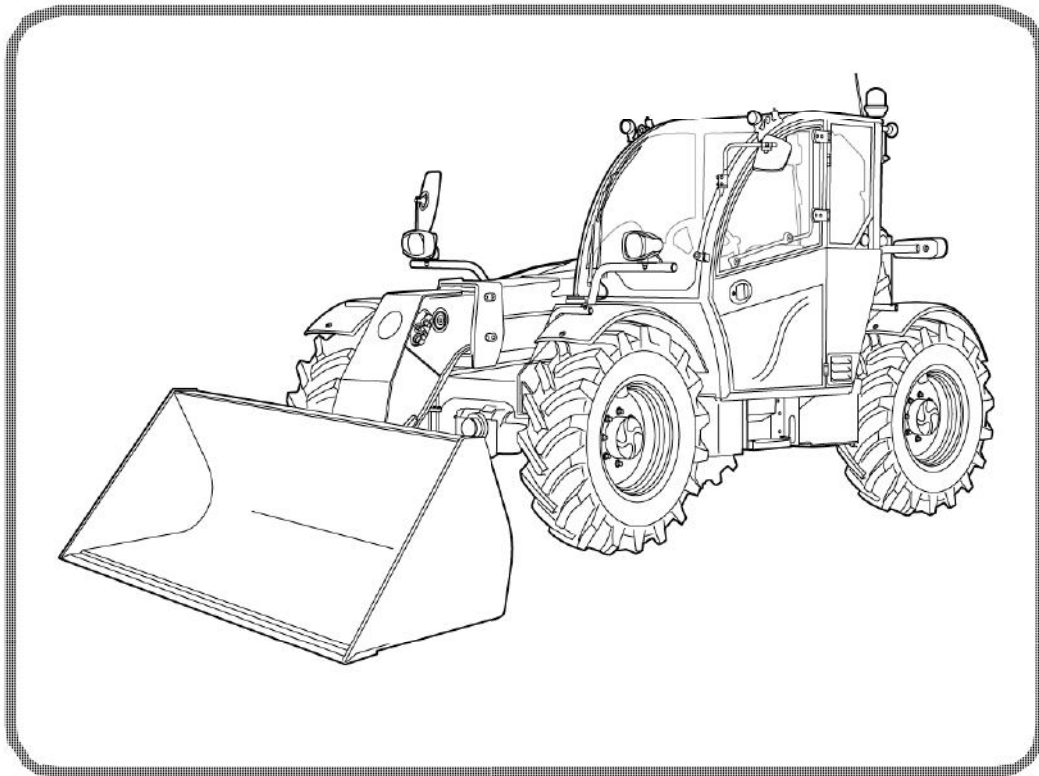

Dealer Copy -- Not for Resale



MAINTENANCE SAFETY



WARNING

Instructions are necessary before operating or servicing machine. Read and understand the Operation & Maintenance Manual, Operator's Handbook and signs (decals) on machine. Follow warnings and instructions in the manuals when making repairs, adjustments or servicing. Check for correct function after adjustments, repairs or service. Untrained operators and failure to follow instructions can cause injury or death.

W-2003-0807

CORRECT



P-90216

- ⚠ Never service the Bobcat telescopic handler without instructions.



Safety Alert Symbol: This symbol with a warning statement, means: "Warning, be alert! Your safety is involved!" Carefully read the message that follows.

CORRECT



NA5428

- ⚠ Cleaning and maintenance are required daily.

WRONG

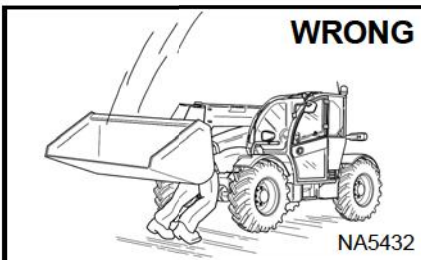

NA5432

- ⚠ Disconnecting or loosening any hydraulic tubeline, hose, fitting, component or a part failure can cause boom to drop. Do not go under boom when raised unless supported by an approved boom stop. Replace if damaged.

WRONG

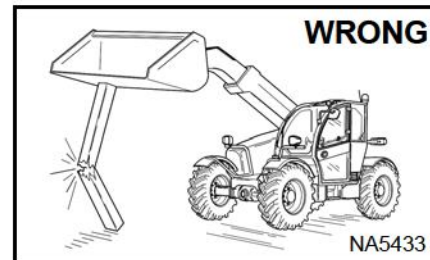

NA5433

- ⚠ Never work on telescopic handler with boom up unless boom is held by an approved boom stop. Replace if damaged.
- ⚠ Never modify equipment or add attachments not approved by Bobcat Company.

WRONG

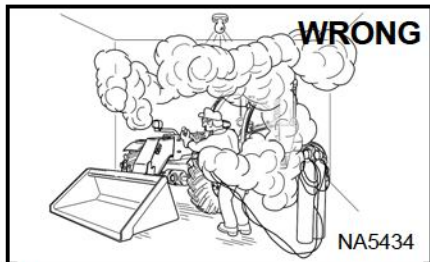

NA5434

- ⚠ Have good ventilation when welding or grinding painted parts.
- ⚠ Wear dust mask when grinding painted parts. Toxic dust and gas can be produced.
- ⚠ Avoid exhaust fume leaks which can kill without warning. Exhaust system must be tightly sealed.

WRONG

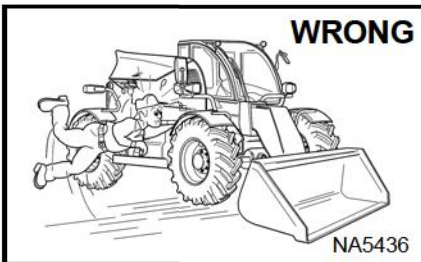

NA5436

- ⚠ Keep body, jewelry and clothing away from moving parts, electrical contact, hot parts and exhaust.
- ⚠ Wear eye protection to guard from battery acid, compressed springs, fluids under pressure and flying debris when engines are running or tools are used. Use eye protection approved for type of welding.

WRONG



B-6589

- ⚠ Lead-acid batteries produce flammable and explosive gases.
- ⚠ Keep arcs, sparks, flames and lighted tobacco away from batteries.
- ⚠ Batteries contain acid which burns eyes or skin on contact. Wear protective clothing. If acid contacts body, flush well with water. For eye contact flush well and get immediate medical attention.

Dealer Copy -- Not for Resale

Maintenance procedures which are given in the Operation & Maintenance Manual can be performed by the owner/operator without any specific technical training. Maintenance procedures which are not in the Operation & Maintenance Manual must be performed **ONLY BY QUALIFIED BOBCAT SERVICE PERSONNEL**. Always use genuine Bobcat replacement parts.

CONTENTS

SAFETY AND MAINTENANCE	10-01
HYDRAULIC SYSTEM	20-01
HYDROSTATIC SYSTEM	30-01
DRIVE SYSTEM	40-01
MAINFRAME	50-01
ELECTRICAL SYSTEM AND ANALYSIS	60-01
ENGINE SERVICE	70-01
HEATING, VENTILATION, AIR CONDITIONING (HVAC)	80-01
SPECIFICATIONS	SPEC-01
ALPHABETICAL INDEX	INDEX-01

Dealer Copy -- Not for Resale

FOREWORD

FOREWORD	1-7
SAFETY INSTRUCTIONS	1-9
Safe Operation Is The Operator's Responsibility	1-9
Safe Operation Needs A Qualified Operator	1-9
Avoid Silica Dust	1-10
FIRE PREVENTION	1-10
Maintenance	1-10
Operation	1-10
Electrical	1-10
Hydraulic System	1-11
Fueling	1-11
Starting	1-11
Welding And Grinding	1-11
Fire Extinguishers	1-11
SERIAL NUMBER LOCATION	1-12
Telescopic Handler Serial Number	1-12
Engine Serial Number	1-13
Other Serial Numbers	1-13
DELIVERY REPORT	1-13
BOBCAT TELESCOPIC HANDLER IDENTIFICATION	1-14

Dealer Copy -- Not for Resale

<https://www.ebooklibonline.com>

Hello dear friend!

Thank you very much for reading.

Enter the link into your browser.











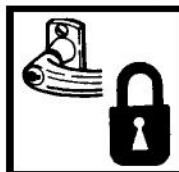

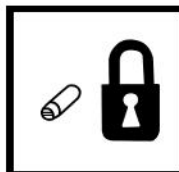
The full manual is available for immediate download.

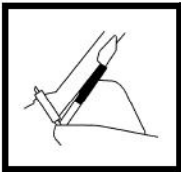
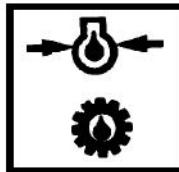
<https://www.ebooklibonline.com>

FOREWORD

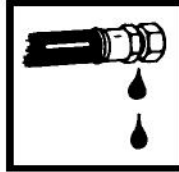
This manual is for the Bobcat telescopic handler mechanic. It provides necessary servicing and adjustment procedures for the Bobcat telescopic handler and its component parts and systems. Refer to the Operation & Maintenance Manual for operating instructions, starting procedure, daily checks, etc.

A general inspection of the following items must be made after the telescopic handler has had service or repair:

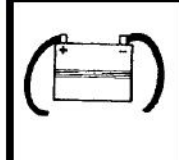
- | | | | |
|---|---|---|---|
| 1. Check that ROPS/FOPS (Including right side window) is in good condition and is not modified. |  | 9. Enclosure door latches must open and close freely. |  |
| 2. Check that ROPS mounting hardware is tightened and is Bobcat approved. |  | 10. Attachment locking pins must function correctly and be in good condition. |  |
| 3. The seat belt must be correctly installed, functional and in good condition. |  | 11. Safety treads must be in good condition. |  |
| 4. Check boom support device, replace if damaged. |  | 12. Check for correct function of indicator lamps and gauges. |  |
| 5. Machine signs must be legible and in the correct location. |  | 13. Check hydraulic fluid level, engine oil level and fuel supply. |  |
| 6. Check tires for wear and pressure. Use only approved tires. |  | 14. Inspect for fuel, oil or hydraulic fluid leaks. |  |
| 7. Check for correct function of the work lights. |  | 15. Lubricate the telescopic handler. |  |
| 8. The parking brake must function correctly. |  | 16. Check the condition of the battery and cables. |  |

Dealer Copy -- Not for Resale

FW TLS EMEA-0411 SM

17. Inspect the air cleaner for damage or leaks. Check the condition of the element.

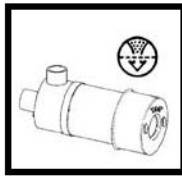

20. Operate the telescopic handler and check all functions.



18. Check the electrical charging system.

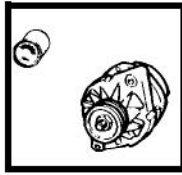

21. Check for any field modification not completed.



19. Inspect for loose or broken parts or connections.



22. Recommend to the owner that all necessary corrections be made before the machine is returned to service.



SAFETY INSTRUCTIONS

Safe Operation Is The Operator's Responsibility

	Safety Alert Symbol
<p>This symbol with a warning statement means: "Warning, be alert! Your safety is involved!" Carefully read the message that follows.</p>	



Operator must have instructions before operating the machine. Untrained operators can cause injury or death.

W-2001-0502



This notice identifies procedures which must be followed to avoid damage to the machine.

I-2019-0284



The signal word **DANGER** on the machine and in the manuals indicates a hazardous situation which, if not avoided, will result in death or serious injury.

D-1002-1107



The signal word **WARNING** on the machine and in the manuals indicates a potentially hazardous situation which, if not avoided, could result in death or serious injury.

W-2044-1107

The Bobcat telescopic handler and attachment must be in good operating condition before use.

Check all of the items on the Bobcat Service Schedule Decal under the 8-10 hour column or as shown in the Operation & Maintenance Manual.

Safe Operation Needs A Qualified Operator

For an operator to be qualified, he or she must not use drugs or alcoholic drinks which impair alertness or coordination while working. An operator who is taking prescription drugs must get medical advice to determine if he or she can safely operate a machine.

A Qualified Operator Must Do The Following:

Understand the Written Instructions, Rules and Regulations

- The written instructions from Bobcat Company include the Delivery Report, Operation & Maintenance Manual, Operator's Handbook and machine signs (decals).
- Check the rules and regulations at your location. The rules may include an employer's work safety requirements. For driving on public roads, the machine must be equipped as stipulated by the local regulations authorising operation on public roads in your specific country. Regulations may identify a hazard such as a utility line.
- For operating the machine, some countries require an operator license. Check the regulations at your location.

Have Training with Actual Operation

- Operator training must consist of a demonstration and verbal instruction. This training is given by your Bobcat dealer before the product is delivered.
- The new operator must start in an area without bystanders or structures and use all the controls until he or she can operate the machine and attachment safely under all conditions of the work area. Always fasten seat belt before operating.

Know the Work Conditions

- Know the weight of the materials being handled. Avoid exceeding the Rated Load Capacity of the machine (as indicated on the Load Capacity Charts). Material which is very dense will be heavier than the same volume of less dense material. Reduce the size of load if handling dense material.
- The operator must know any prohibited uses or work areas, for example, he or she needs to know about excessive slopes.
- Know the location of any underground lines.
- Wear tight fitting clothing. Always wear safety glasses when doing maintenance or service. Safety glasses, respiratory equipment, hearing protection or Front Window Guard are required for some work. See your Bobcat dealer about Bobcat Safety Equipment.

Dealer Copy -- Not for Resale

SI VH EMEA-1010 SM

SAFETY INSTRUCTIONS (CONT'D)

Safe Operation Needs A Qualified Operator (Cont'd)

Where overhead power lines are present in the operating area, ensure sufficient clearance between the nearest of these lines and any part of the machine.

VOLTAGE	MINIMUM DISTANCE
up to 50 kV	3 m
beyond 50 kV	5 m

The operator must survey his/her field of vision when operating the Telescopic Handler. Adjust mirrors to obtain the best visibility. Clean mirrors every day and more often when necessary. Immediately replace any broken or damaged mirrors. If a suspended load or the resulting boom geometry blocks the vision of the operator alternative carrying means must be considered.

The operator must know the wind speed. Do not use the telescopic handler with wind speeds over 12,5 m/s.

Avoid Silica Dust



Cutting or drilling concrete containing sand or rock containing quartz may result in exposure to silica dust. Use a respirator, water spray or other means to control dust.

FIRE PREVENTION



Maintenance

The machine and some attachments have components that are at high temperatures under normal operating conditions. The primary source of high temperatures is the engine and exhaust system. The electrical system, if damaged or incorrectly maintained, can be a source of arcs or sparks.

Flammable debris (leaves, straw, etc.) must be removed regularly. If flammable debris is allowed to accumulate, it can cause a fire hazard. Clean often to avoid this accumulation. Flammable debris in the engine compartment is a potential fire hazard.

The operator's area, engine compartment and engine cooling system must be inspected every day and cleaned if necessary to prevent fire hazards and overheating.

All fuels, most lubricants and some coolants mixtures are flammable. Flammable fluids that are leaking or spilled onto hot surfaces or onto electrical components can cause a fire.

Operation

Do not use the machine where exhaust, arcs, sparks or hot components can contact flammable material, explosive dust or gases.

Electrical



Check all electrical wiring and connections for damage. Keep the battery terminals clean and tight. Repair or replace any damaged part or wires that are loose or frayed.

Battery gas can explode and cause serious injury. Use the procedure in the Operation & Maintenance Manual for connecting the battery and for jump starting. Do not jump start or charge a frozen or damaged battery. Keep any open flames or sparks away from batteries. Do not smoke in battery charging area.

SI VH EMEA-1010 SM

FIRE PREVENTION (CONT'D)

Hydraulic System

Check hydraulic tubes, hoses and fittings for damage and leakage. Never use open flame or bare skin to check for leaks. Hydraulic tubes and hoses must be properly routed and have adequate support and secure clamps. Tighten or replace any parts that show leakage.

Always clean fluid spills. Do not use petrol or diesel fuel for cleaning parts. Use commercial non-flammable solvents.

Fueling



Stop the engine and let it cool before adding fuel. No smoking! Do not refuel a machine near open flames or sparks. Fill the fuel tank outdoors.

Starting

Do not use ether or starting fluids on any engine that has glow plugs. These starting aids can cause explosion and injure you or bystanders.

Use the procedure in the Operation & Maintenance Manual for connecting the battery and for jump starting.

Welding And Grinding

Always clean the machine and attachment, disconnect the battery, and disconnect the wiring from the Bobcat controllers before welding. Cover rubber hoses, battery and all other flammable parts. Keep a fire extinguisher near the machine when welding.

Have good ventilation when grinding or welding painted parts. Wear dust mask when grinding painted parts. Toxic dust or gas can be produced.

Dust generated from repairing non-metallic parts such as hoods, fenders or covers can be flammable or explosive. Repair such components in a well ventilated area away from open flames or sparks.

Fire Extinguishers

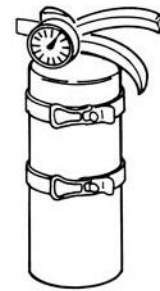

Know where fire extinguishers and first aid kits are located and how to use them. Inspect the fire extinguisher and service the fire extinguisher regularly. Obey the recommendations on the instructions plate.

Dealer Copy Not for Resale

SERIAL NUMBER LOCATION

Always use the serial number of the telescopic handler when requesting service information or when ordering parts.

If any serial number plate is damaged, contact your Bobcat dealer.

Figure 1

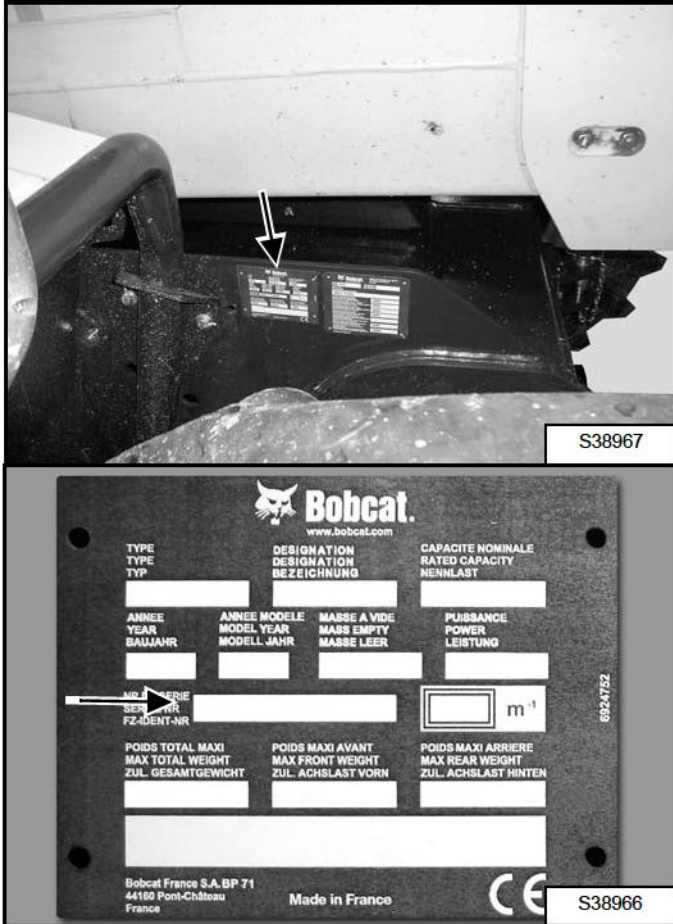

Telescopic Handler Serial Number

The telescopic handler serial number plate is located on the right side of the frame in front [Figure 1].

Explanation of telescopic handler serial number:

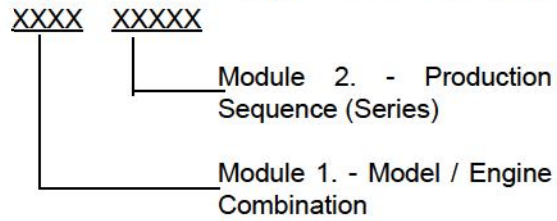

1. The four digit Model / Engine Combination Module number identifies the model number and engine combination.

2. The five digit Production Sequence Number identifies the order which the telescopic handler is produced.

SERIAL NUMBER LOCATION (CONT'D)

Engine Serial Number

Figure 2

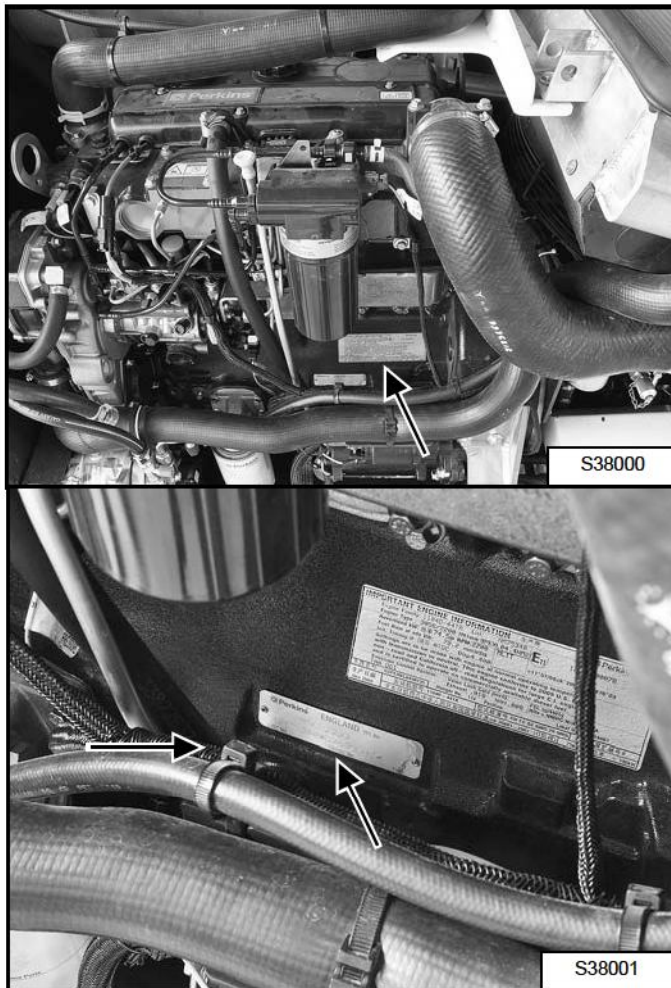

The engine serial number can be found on the engine serial number plate [Figure 2] in front of you when opening the engine cover. Always use the full number when ordering replacement parts.

Other Serial Numbers

Other components can also have serial numbers and an identification plate. Always use these serial numbers when ordering parts.

DELIVERY REPORT

Figure 3

The image shows a sample delivery report form. It has a header section titled 'DELIVERY REPORT' with several lines for text entry. Below this is a section titled 'WARNING' with a large 'X' mark over it, indicating it should be read. The form is enclosed in a rectangular border. In the bottom right corner of the form area, the text 'B-16315' is visible.

The delivery report must be completed by the dealer and signed by the owner or operator when the Bobcat telescopic handler is delivered. An explanation of the form must be given to the owner. Make sure it is complete [Figure 3].

Dealer Copy -- Not for Resale

BOBCAT TELESCOPIC HANDLER IDENTIFICATION

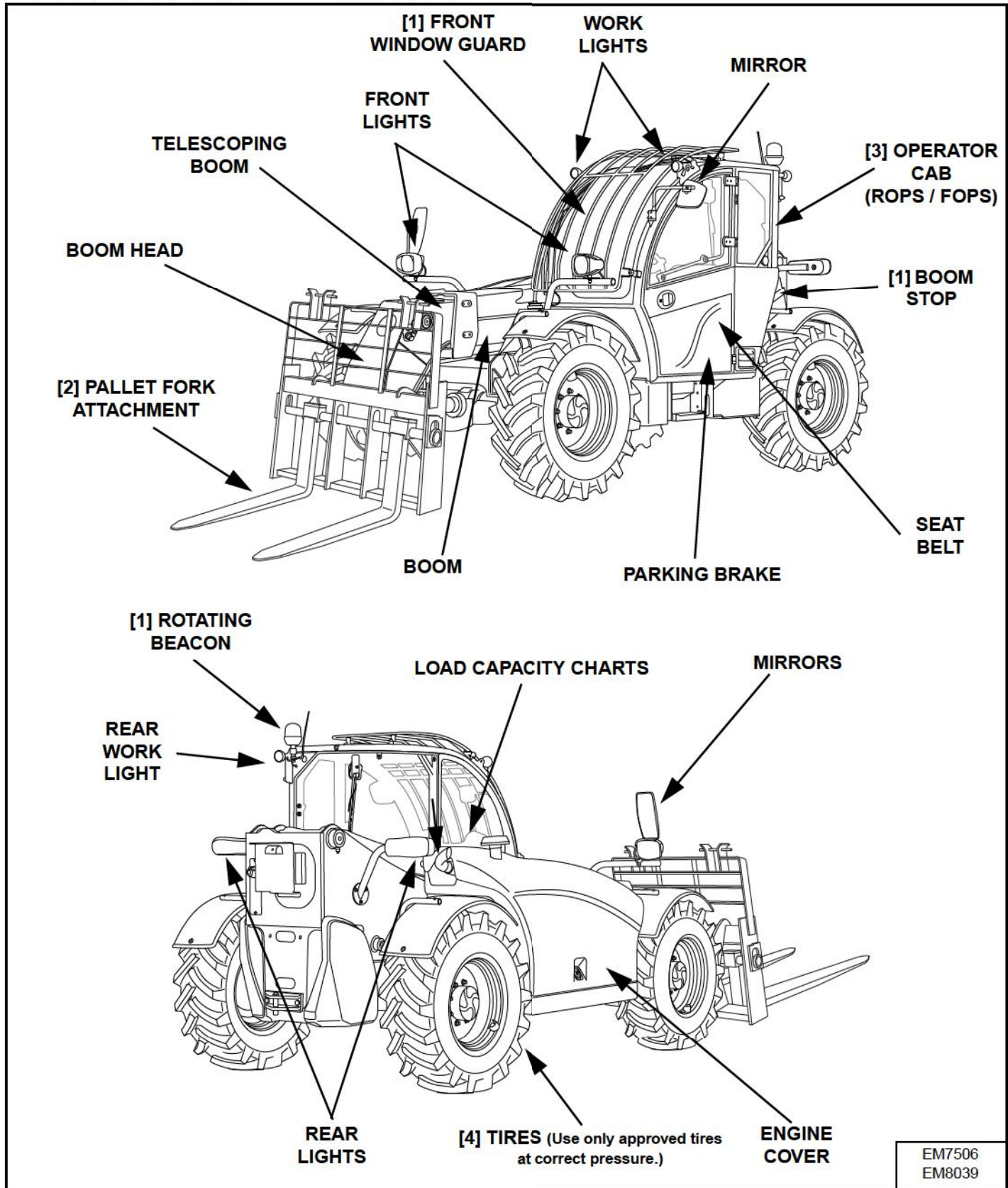

[1] Optional or Field Accessory. (Not Standard Equipment).

[2] Attachments - Several different attachments are available for the Bobcat telescopic handler.

[3] ROPS, FOPS - Roll Over Protective Structure, per ISO 3471, and Falling Object Protective Structure per ISO 3449, Level II.

[4] TIRES - Standard tires are shown. Several different tire styles and sizes are available for the Bobcat telescopic handler.

Dealer Copy -- Not for Resale

SAFETY AND MAINTENANCE

LIFTING AND BLOCKING THE TELESCOPIC HANDLER	10-10-1
Procedure	10-10-1
OPERATOR CAB	10-20-1
Description	10-20-1
Cab Door	10-20-1
Cab Door Window	10-20-2
Rear Cab Window	10-20-3
Cab Light	10-20-3
TRANSPORTING THE TELESCOPIC HANDLER ON A TRAILER	10-30-1
Loading And Unloading	10-30-1
Fastening	10-30-1
TOWING THE TELESCOPIC HANDLER	10-40-1
Procedure	10-40-1
SERVICE SCHEDULE	10-50-1
AIR CLEANER SERVICE	10-60-1
Replacing Filter Elements	10-60-1
ENGINE COOLING SYSTEM	10-70-1
Cleaning	10-70-1
Checking Level	10-70-2
Removing And Replacing The Coolant	10-70-3
FUEL SYSTEM	10-80-1
Fuel Specifications	10-80-1
Biodiesel Blend Fuel	10-80-1
Filling The Fuel Tank	10-80-2
Primary Fuel Filter (Pre-Filter)	10-80-2
Secondary Fuel Filter	10-80-4
Removing Air From The Fuel System	10-80-5
ENGINE LUBRICATION SYSTEM	10-90-1
Checking And Adding Engine Oil	10-90-1
Engine Oil Chart	10-90-1
Removing And Replacing Oil And Filter	10-90-2
HYDRAULIC / HYDROSTATIC SYSTEM	10-100-1
Checking And Adding Fluid	10-100-1
Hydraulic / Hydrostatic Fluid Chart	10-100-2
Removing And Replacing Hydraulic Fluid	10-100-2
Removing And Replacing Hydraulic / Hydrostatic Filter	10-100-3
Removing And Replacing Hydraulic Charge Filter	10-100-4
Fill / Breather Cap	10-100-5
AXLES (FRONT AND REAR)	10-110-1
Checking And Adding Oil (Planetary Carrier)	10-110-1

Dealer Copy -- Not for Resale

Removing And Replacing Oil (Planetary Carrier)	10-110-1
Checking And Adding Oil (Rear Differential)	10-110-2
Removing And Replacing Oil (Rear Differential)	10-110-2
Checking And Adding Oil (Front Differential)	10-110-3
Removing And Replacing Oil (Front Differential)	10-110-3
Checking And Adding Oil (Gear Box)	10-110-4
Removing And Replacing Oil (Gear Box)	10-110-4
LUBRICATING THE TELESCOPIC HANDLER	10-120-1
Lubrication Locations	10-120-1
ATTACHMENT CARRIER	10-130-1
Inspection And Maintenance	10-130-1
TYRE MAINTENANCE	10-140-1
Wheel Nuts	10-140-1
Rotating	10-140-1
Mounting	10-140-1
Pressure	10-140-1
APPROVED BOOM STOP	10-150-1
Installing The Approved Boom Stop	10-150-1
Removing The Approved Boom Stop	10-150-1
ENGINE COVER	10-160-1
Opening And Closing	10-160-1
STOPPING THE ENGINE AND LEAVING THE TELESCOPIC HANDLER	10-170-1
Procedure	10-170-1
EMERGENCY EXIT	10-180-1
Right Rear Window	10-180-1
TELESCOPIC HANDLER STORAGE AND RETURN TO SERVICE	10-190-1
Storage	10-190-1
Return To Service	10-190-1
LIFTING THE TELESCOPIC HANDLER	10-200-1
Procedure	10-200-1
REMOTE START TOOL (SERVICE TOOL) KIT - MEL1563	10-210-1
Remote Start Tool - MEL1563	10-210-1
Service Tool Harness Control - MEL1565	10-210-2
Service Tool Harness Communicator - MEL1566	10-210-3
REMOTE START TOOL (SERVICE TOOL) KIT - 7003031	10-220-1
Remote Start Tool (Service Tool) - 7003030	10-220-1
Telescopic Handler Service Tool Harness - 6689747	10-220-2
Computer Service Tool Harness - 6689746	10-220-4
Remote Start Procedure	10-220-4

LIFTING AND BLOCKING THE TELESCOPIC HANDLER

Procedure

Always park the machine on a level surface.

 **WARNING**

**MACHINE FALLING OR MOVING CAN CAUSE
SERIOUS INJURY OR DEATH**

**Put jackstands under the front and rear of the
machine before running engine for service.**

W-2718-0208

Figure 10-10-1



STOP the engine. Put the floor jack under the left side of the front axle. Lift the telescopic handler and install the first jackstand [Figure 10-10-1].

Figure 10-10-2

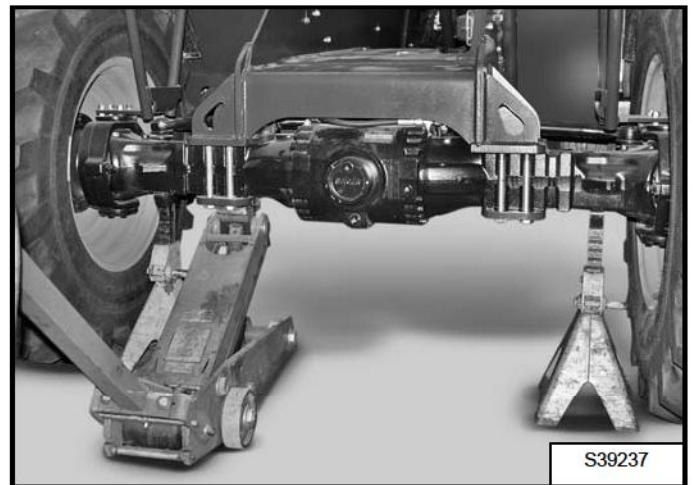

Put the floor jack under the right side of the front axle. Lift the telescopic handler and install the second jackstand [Figure 10-10-2].

Figure 10-10-3

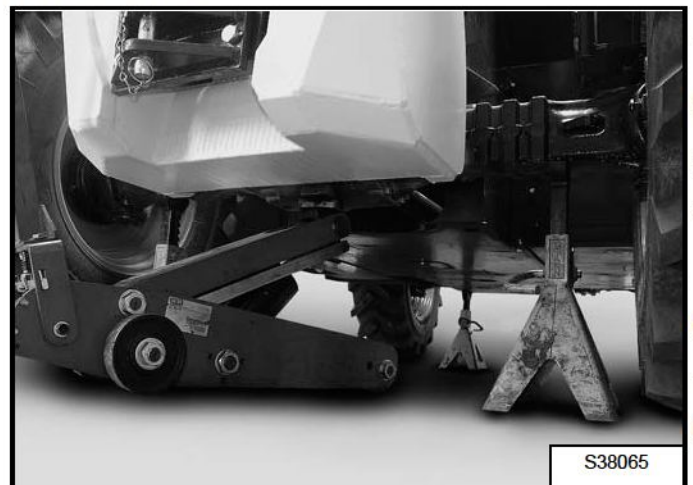

Put the floor jack under the center of the rear axle. Lift the telescopic handler and install jackstands [Figure 10-10-3].

Dealer Copy -- Not for Resale

OPERATOR CAB

Description

The Bobcat telescopic handler has an operator cab (ROPS / FOPS) as standard equipment to protect the operator. The seat belt must be worn for ROPS / FOPS protection.

Check the ROPS / FOPS cab, mounting, and hardware for damage. Never modify the ROPS / FOPS cab. Replace the cab and hardware if damaged. See your Bobcat dealer for parts.

ROPS / FOPS - Roll Over Protective Structure per ISO 3471, Falling Object Protective Structure per ISO 3449 (FOPS Level II) and OECD code 4 and code 9.

Operator cab category 1 per EN 15695-1:2009.

The operator cab does not provide protection against hazardous substances. Do not use this machine under conditions requiring protection against hazardous substances.



Never modify operator cab by welding, grinding, drilling holes or adding attachments unless instructed to do so by Bobcat Company. Do not operate without right window. Changes to the cab can cause loss of operator protection from rollover and falling objects, and result in serious injury or death.

W-2906-0211

Cab Door

Figure 10-20-1

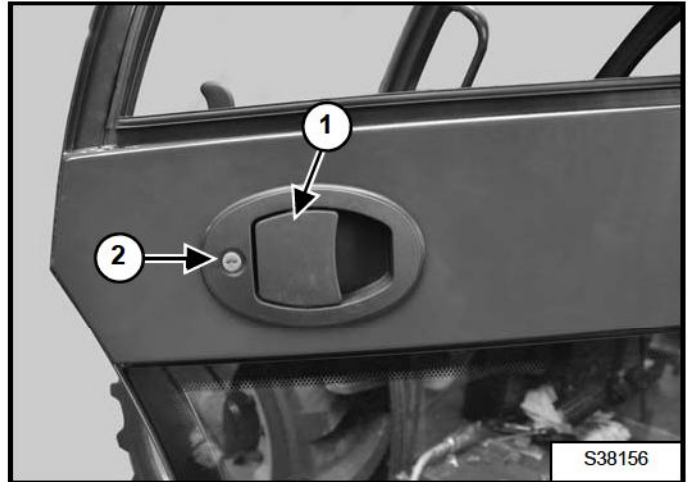
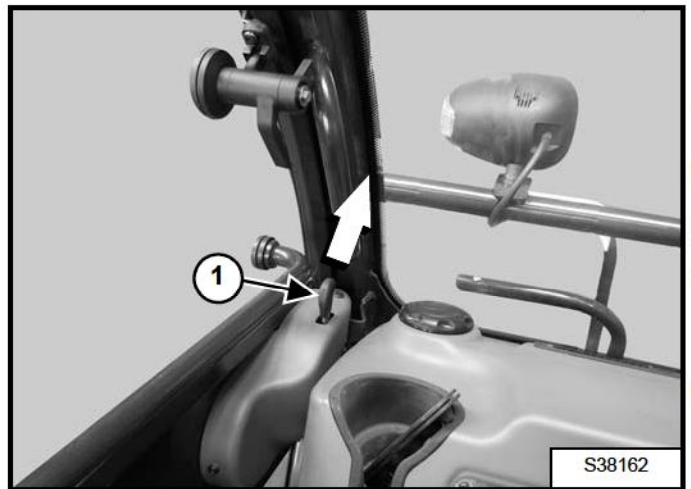

Figure 10-20-2



The cab door can be opened from the outside of the cab using the latch (Item 1) [Figure 10-20-1] and opened from the inside of the cab when you push the lever (Item 1) [Figure 10-20-2] (as shown).

The cab door can be locked (Item 2) [Figure 10-20-1] with the same key as the starter switch.

Dealer Copy -- Not for Resale

OPERATOR CAB (CONT'D)

Cab Door Window

Figure 10-20-3

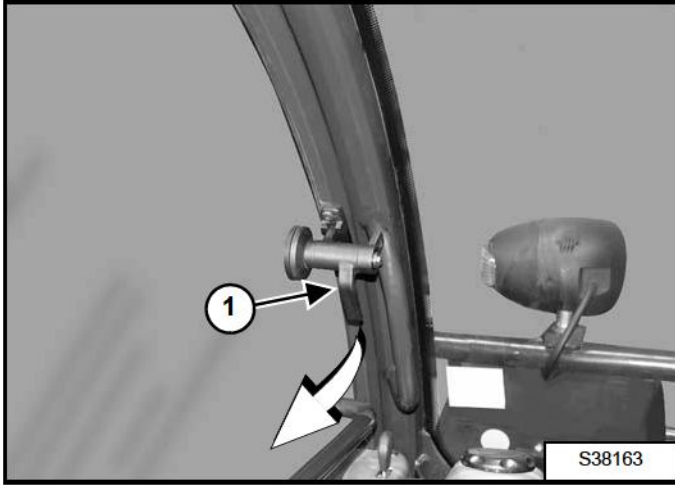

Turn the handle (Item 1) [Figure 10-20-3] (as shown) to unlock the window. Push the window fully open until it latches against the cab.

Figure 10-20-4

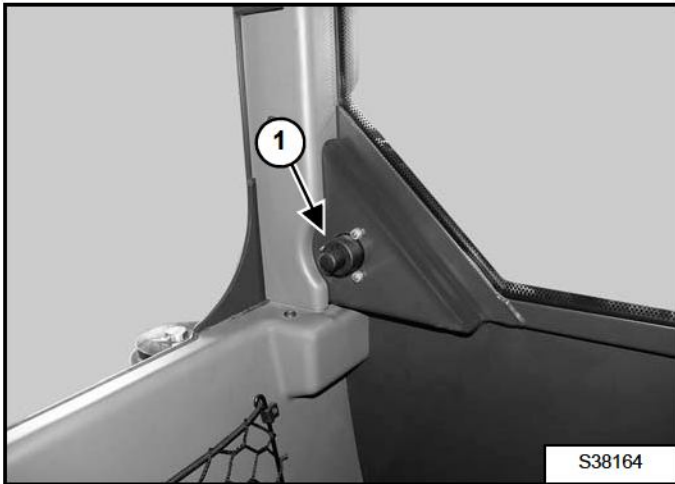

Push the knob (Item 1) [Figure 10-20-4] inside the cab to disengage the latch and close the window.

Figure 10-20-5

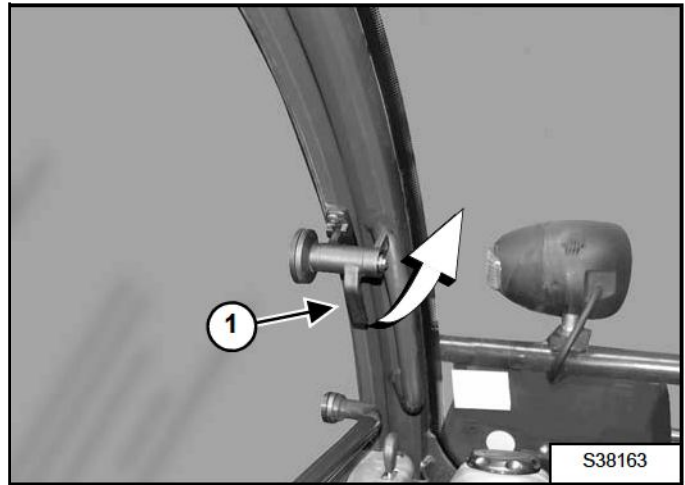

Turn the handle (Item 1) [Figure 10-20-5] back into the original position (as shown) to lock the window.

Figure 10-20-6

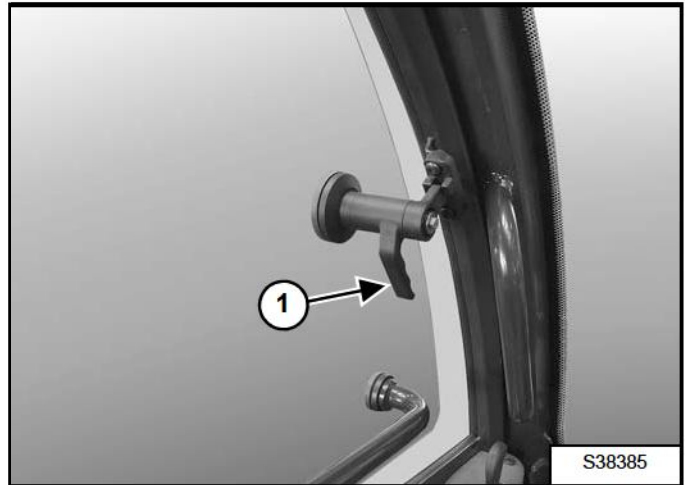

The handle (Item 1) [Figure 10-20-6] can also be used to fixate the window in a partly open position.

OPERATOR CAB (CONT'D)

Rear Cab Window

Figure 10-20-7

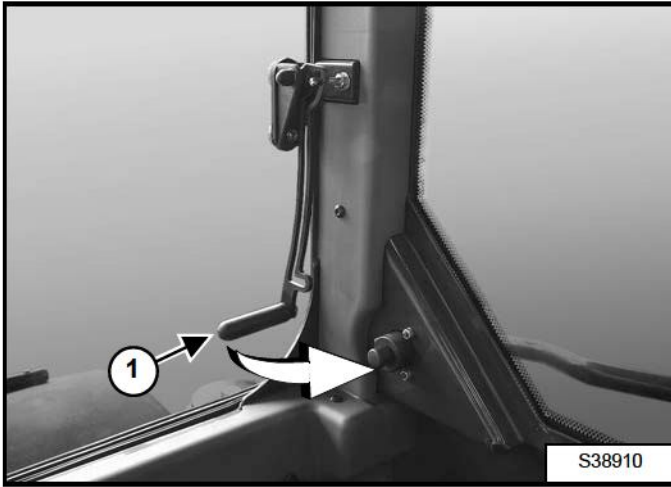

Turn the handle (Item 1) [Figure 10-20-7] (as shown) to unlock the rear window.

Figure 10-20-8

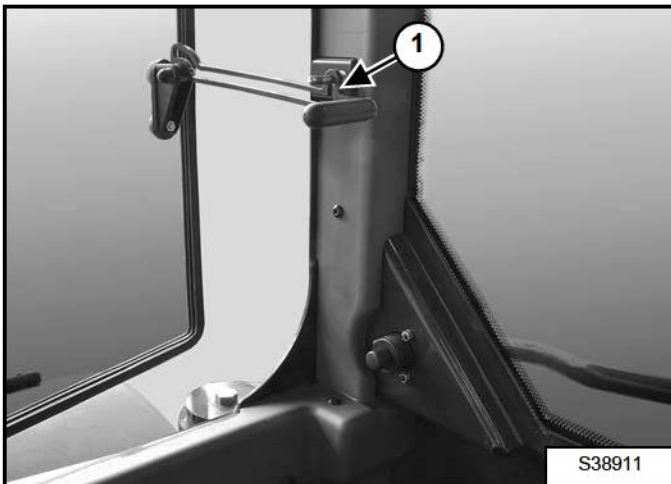

Push the rear window open until the handle lock (Item 1) [Figure 10-20-8] is locked in the open position (as shown).

Cab Light

Figure 10-20-9

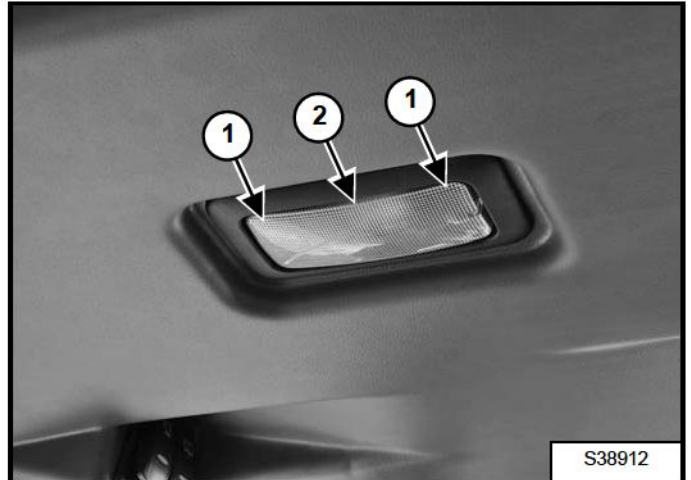

The Cab Light [Figure 10-20-9] is located above the operator's right shoulder.

Move the lens to the left or the right (Item 1) to turn the light ON. Move the lens to the centre position (Item 2) [Figure 10-20-9] to turn the light OFF.

Dealer Copy -- Not for Resale

TRANSPORTING THE TELESCOPIC HANDLER ON A TRAILER

Loading And Unloading

Figure 10-30-1



The telescopic handler must be loaded backward on the trailer.

The rear of the trailer must be blocked or supported (Item 1) [Figure 10-30-1] when loading or unloading the telescopic handler to prevent the front end of the trailer from raising up.

Be sure the transport and towing vehicles are of adequate size and capacity. For the weight of telescopic handler, (See Weights on Page SPEC-10-2.).

WARNING

AVOID SERIOUS INJURY OR DEATH

Adequately designed ramps of sufficient strength are needed to support the weight of the machine when loading onto a transport vehicle. Wood ramps can break and cause personal injury.

W-2058-0807

Fastening

Figure 10-30-2

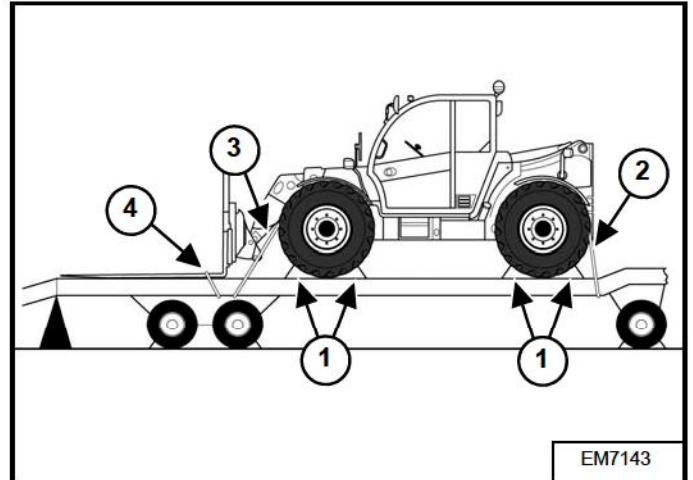

Fasten the telescopic handler to the transport vehicle to prevent it from moving during sudden stops or when going up or down slopes.

- Block the wheels (Item 1) [Figure 10-30-2].
- Use chains to fasten the machine frame to the transport vehicle (Items 2 and 3) [Figure 10-30-2]. Use chain binders to tighten the chains.
- Attach the forks or bucket attachment to the transport vehicle (Item 4) [Figure 10-30-2].

Dealer Copy -- Not for Resale

TOWING THE TELESCOPIC HANDLER

Procedure

The telescopic handler can be towed a short distance such as removing it from mud or loading onto a transport vehicle.

Tow the telescopic handler at a slow speed, not exceeding 5 km/h (3 mph). Do not tow the machine for more than three minutes.

! WARNING

UNEXPECTED MACHINE MOVEMENT CAN CAUSE SERIOUS INJURY OR DEATH

- Block wheels to prevent roll away before adjusting screws to bypass the park brake system.
- Return adjustment screws to the operating position before operating the machine.

W-2808-0909

Block the wheels to prevent the machine from rolling.

Disengaging The Parking Brake Pads

The parking brake is engaged by spring pressure and released by hydraulic pressure. The parking brake must be released manually before towing.

The following procedure describes how to disengage the parking brake pads:

Release the parking brake. (See Operation & Maintenance Manual for correct procedure.)

Figure 10-40-1

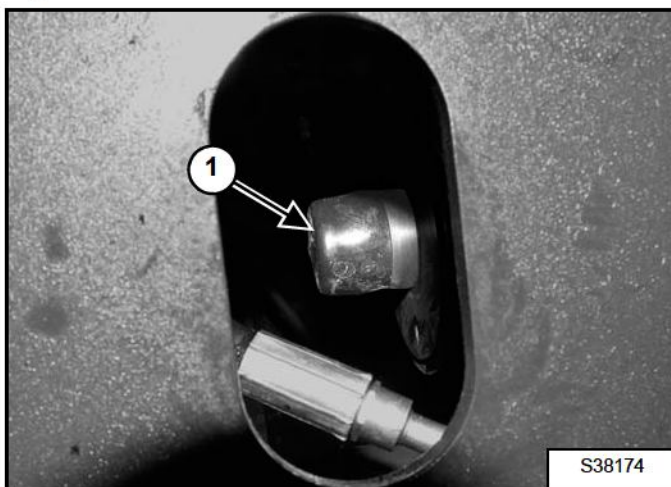

Remove the cap (Item 1) [Figure 10-40-1]. The cap can be accessed from the underside of the machine, through the oval hole (Item 1) [Figure 10-40-2].

Figure 10-40-2

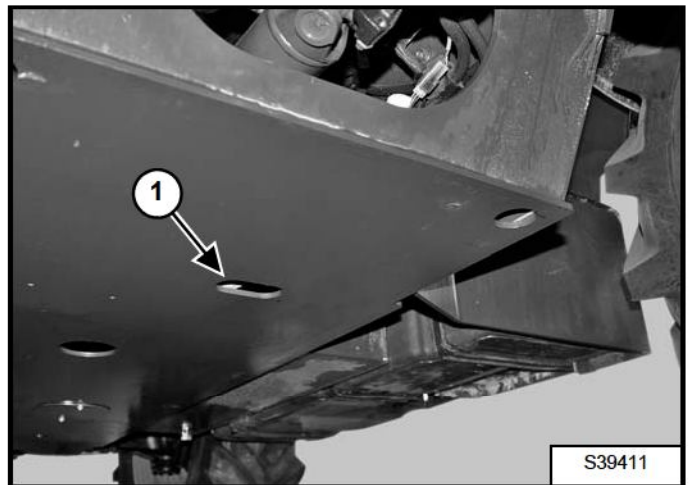
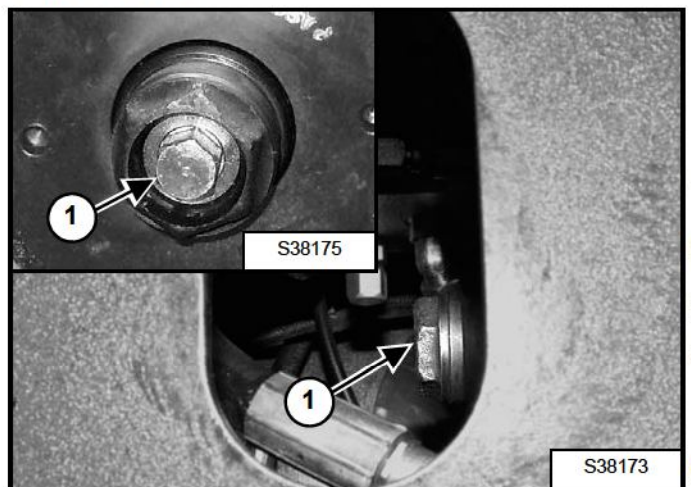

Figure 10-40-3



Turn the adjustment screw (Item 1) [Figure 10-40-3] anticlockwise until the brake pads no longer make contact with the brake disc.

The parking brake is released manually now for towing the machine.

NOTE: The parking brake will not work until the adjustment screw is returned to the original position.

Dealer Copy -- Not for Resale

TOWING THE TELESCOPIC HANDLER (CONT'D)

Procedure (Cont'd)

Disengaging The Transmission

Raise the engine cover.

Figure 10-40-4

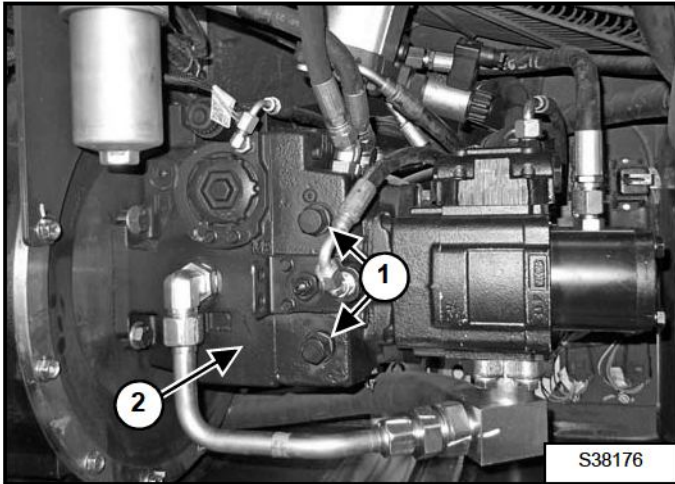

Locate the two identical multi-function valves (Item 1) on the hydrostatic transmission pump (Item 2) [Figure 10-40-4].

Loosen the valves (Item 1) [Figure 10-40-4] by turning them three times anticlockwise.

NOTE: Do not turn more than three times. This can result in leakage.

This action will bypass the oil flow of the hydrostatic transmission.

Tow the telescopic handler at a slow speed, not exceeding 5 km/h (3 mph). Do not tow the machine for more than three minutes.

Engaging The Transmission

Tighten the valves (Item 1) [Figure 10-40-4] to 70 N·m (52 ft-lb) torque to re-engage the hydrostatic transmission.

Engaging The Parking Brake Pads

WARNING

UNEXPECTED MACHINE MOVEMENT CAN CAUSE SERIOUS INJURY OR DEATH

- Block wheels to prevent roll away before adjusting screws to bypass the park brake system.
- Return adjustment screws to the operating position before operating the machine.

W-2808-0909

Block the wheels to prevent the machine from rolling.

Figure 10-40-5

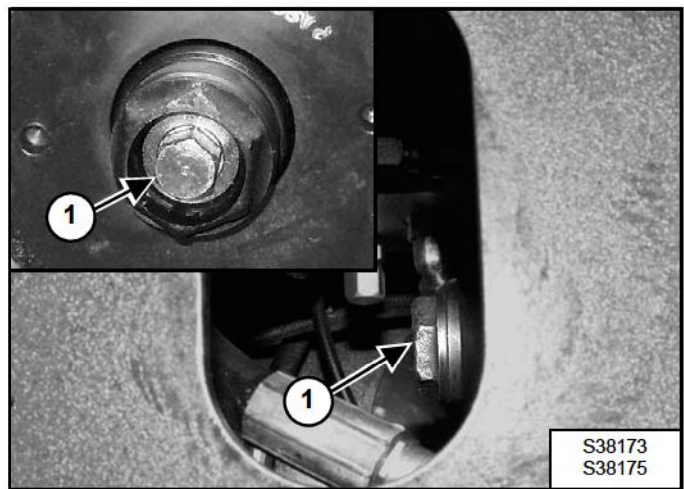

NOTE: Before re-engaging the parking brake pads, make sure the parking brake is released. (See Operation & Maintenance Manual for the correct procedure.)

Turn the adjustment screw (Item 1) [Figure 10-40-5] clockwise until the parking brake pads make contact with the brake disc.

Turn the adjustment screw anticlockwise for 180°.

Engage the parking brake (See Operation & Maintenance Manual for the correct procedure.) and make sure it functions correctly (the engagement between the parking brake pads and the brake disc prevents the machine from moving).

Dealer Copy -- Not for Resale

SERVICE SCHEDULE

Maintenance work must be done at regular intervals. Failure to do so will result in excessive wear and early failures. The service schedule is a guide for correct maintenance of the Bobcat telescopic handler.

 WARNING	<p>Instructions are necessary before operating or servicing machine. Read and understand the Operation & Maintenance Manual and signs (decals) on machine. Follow warnings and instructions in the manuals when making repairs, adjustments or servicing. Check for correct function after adjustments, repairs or service. Untrained operators and failure to follow instructions can cause injury or death.</p> <p style="text-align: right;">W-2003-EN-0903</p>
--	--

SERVICE SCHEDULE		HOURS					
ITEM	SERVICE REQUIRED	10	50	100	250	500	[4] 1000
Engine Oil	Check the oil level and add as needed. Do not overfill.						
Hydraulic Fluid	Check fluid level and add as needed.						
Safety Signs (Decals), Safety Tread And Mirrors	Check for damaged signs (decals), safety tread and mirrors. Replace if damaged or worn.						
Fuel Filter	Remove the trapped water.						
Seat Belt	Check condition. Check mounting hardware.						
Service Brakes	Check for function. Service as necessary.						
Parking Brake	Check for function. Adjust or service as necessary.						
Back-up Alarm (if equipped)	Check for correct operation and repair as needed.						
Tyres	Check for wear or damage. Inflate to correct pressure. Be sure all tyres are inflated to the same pressure. Use only approved tyres.						
Engine Air Filter And Air System	Check condition indicator and empty dust cup as needed. Check air system for leaks.						
Engine Cooling System	Check oil cooler, radiator and air conditioner condenser. Check coolant level cold in reservoir. Add premixed coolant as necessary. (See ENGINE COOLING SYSTEM.) Check cooling system for leaks.						
Tilt Cylinder	Lubricate with multipurpose lithium based grease.						
Attachment Carrier Pins	Lubricate with multipurpose lithium based grease.						
Articulation Pins, Axle Oscillation (Front / Rear), Lift Cyl., Boom Pivot, Levelling Cyl.	Lubricate with multipurpose lithium based grease.						
Telescopic Boom Wear Pads	Lubricate with multipurpose lithium based grease.						
Hydraulic Hoses, Tubelines and Connections	Check for damage and leaks. Repair or replace as needed.						
Wheel Nuts	Check for loose wheel nuts and tighten to correct torque. (See TYRE MAINTENANCE in this manual.)	[1]					
LLMC System	Test LLMC calibration. (See LLMC CALIBRATION TEST.)			[2]			
Alt. and Air Cond. Belt (if equipped)	Check condition. Replace as needed.		[2]				
Engine Oil and Filter	Replace oil and filter.		[2]				
Fuel Filter, Secondary	Replace fuel filter.		[2]				
Fuel Filter, Primary	Replace fuel filter.		[2]				
Hydraulic Tank Breather	Replace the hydraulic tank breather.						
Telescopic Boom Wear Pads	Check wear pads for wear. Replace as necessary.						
Service Brake Pedal Spring	Lubricate with multipurpose lithium based grease.						
Cab Air Filter	Check condition. Replace as necessary.						
Hydraulic / Hydrostatic Fluid Filter	Replace the hydraulic filter element. Use a genuine Bobcat filter.		[2]				
Axle and Differential Fluid	Replace the fluid. (See SPECIFICATIONS for correct oil type and capacities.)			[2]			
Planetary Carriers	Replace the fluid. (See SPECIFICATIONS for correct oil type and capacities.)				[3]		
Gear Box Fluid	Replace the fluid. (See SPECIFICATIONS for correct oil type and capacities.)			[2]		[3]	
Hydraulic Fluid	Replace the hydraulic fluid. (See SPECIFICATIONS for correct oil type and capacities.)						
Engine Coolant	Replace the coolant.	Every 2 years					

- [1] Check wheel nut torque every 8 hours for the first 24 hours.
- [2] Perform service first time, then as indicated in chart.
- [3] Check level.
- [4] Or every 12 months.

Dealer Copy -- Not for Resale

AIR CLEANER SERVICE

Replacing Filter Elements

Outer Filter

Figure 10-60-1

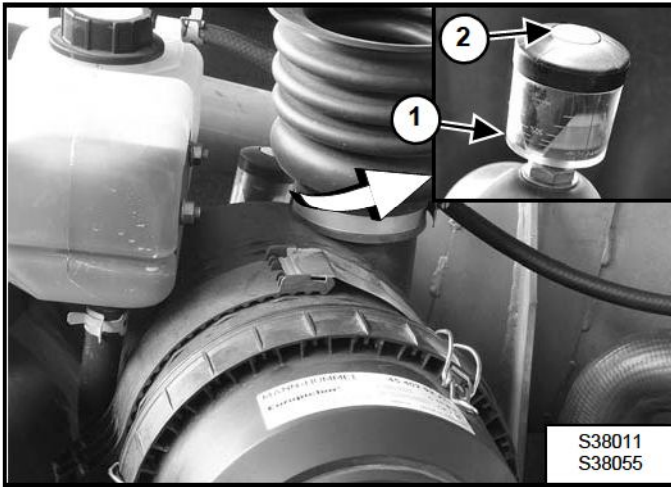

Replace the large (outer) filter element only when the yellow ring has reached the red zone on the condition indicator (Item 1) [Figure 10-60-1].

NOTE: Before replacing the filter element, push the button on the condition indicator (Item 2) [Figure 10-60-1]. Start the engine. If the yellow ring of the condition indicator does not reach the red zone, do not replace the filter element.

Figure 10-60-2

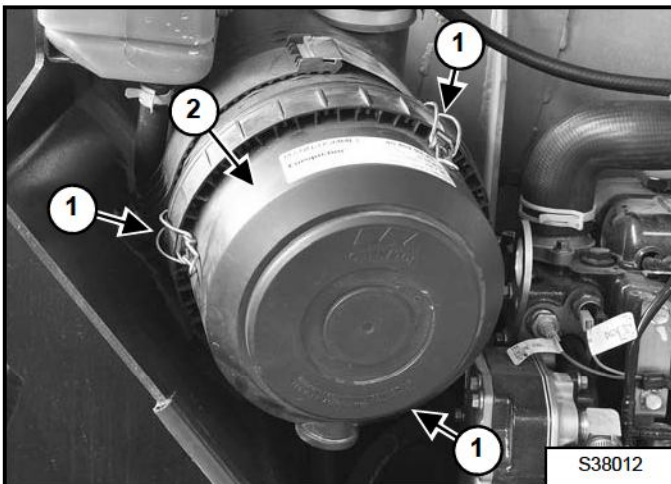

Loosen the filter housing clamps (Item 1) [Figure 10-60-2].

Remove the dust cover (Item 2) [Figure 10-60-2].

Figure 10-60-3

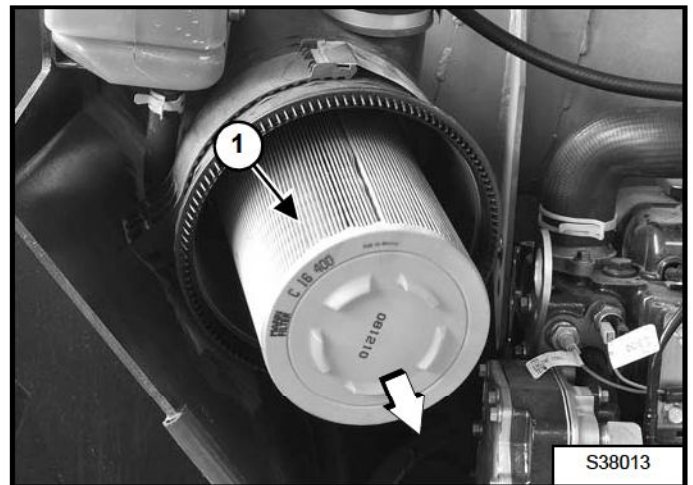

Pull the outer filter element (Item 1) [Figure 10-60-3] straight out and discard.

NOTE: Make sure all sealing surfaces are free of dirt and debris. **DO NOT** use compressed air.

Install a new outer element.

Figure 10-60-4

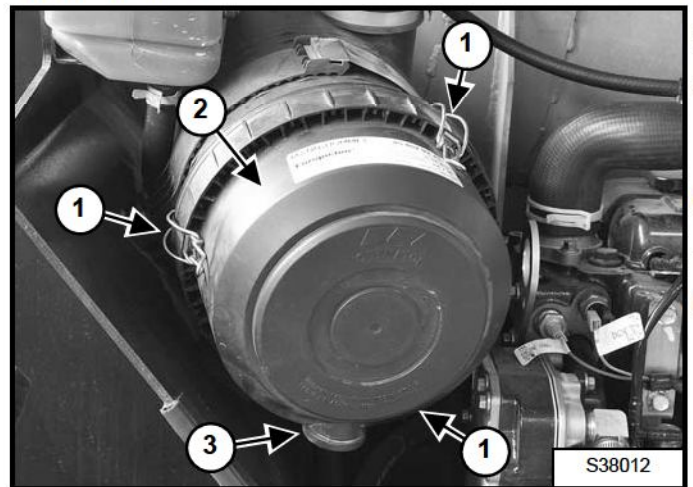

Install the dust cover (Item 2) with the dust extractor (Item 3) [Figure 10-60-4] facing down.

Fasten the filter housing clamps (Item 1) [Figure 10-60-4].

Dealer Copy -- Not for Resale

AIR CLEANER SERVICE (CONT'D)

Replacing Filter Elements (Cont'd)

Inner Filter

Only replace the inner filter element under the following conditions:

- Replace the inner filter element every third time the outer filter is replaced.
- After the outer element has been replaced, start the engine and run at full rpm. If the yellow ring is still in the red zone of the indicator window, replace the inner filter element.

Remove the outer element.

NOTE: Make sure all sealing surfaces are free of dirt and debris. **DO NOT** use compressed air.

Figure 10-60-5

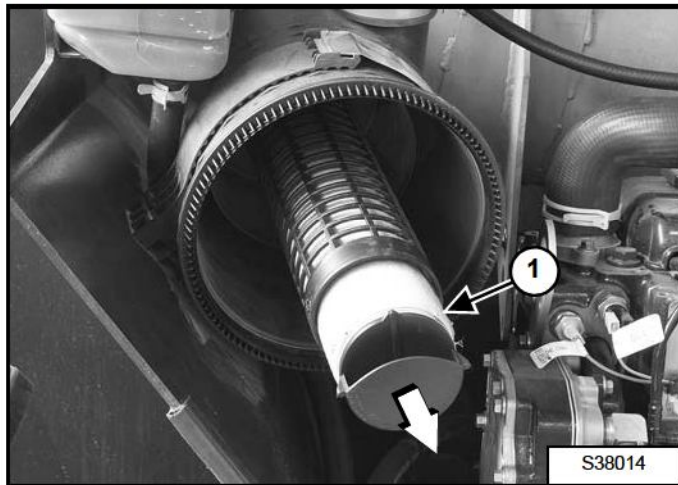

Remove the inner filter element (Item 1) [Figure 10-60-5] and install a new element.

Install the outer element.

Install the dust cover (Item 2) with the dust extractor (Item 3) [Figure 10-60-4] facing down.

Fasten the filter housing clamps (Item 1) [Figure 10-60-4].

ENGINE COOLING SYSTEM

Check the cooling system every day to prevent overheating, loss of performance or engine damage.

Cleaning

Stop the engine and open the engine cover. (See Opening And Closing on Page 10-160-1.)

Figure 10-70-1

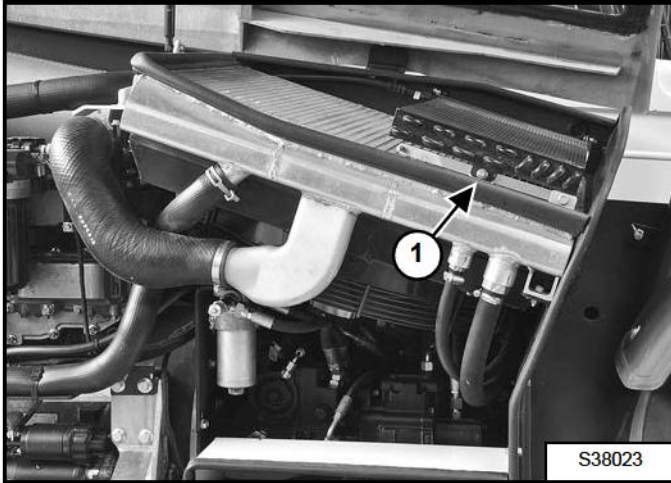

Remove the nut (Item 1) [Figure 10-70-1].

Figure 10-70-2

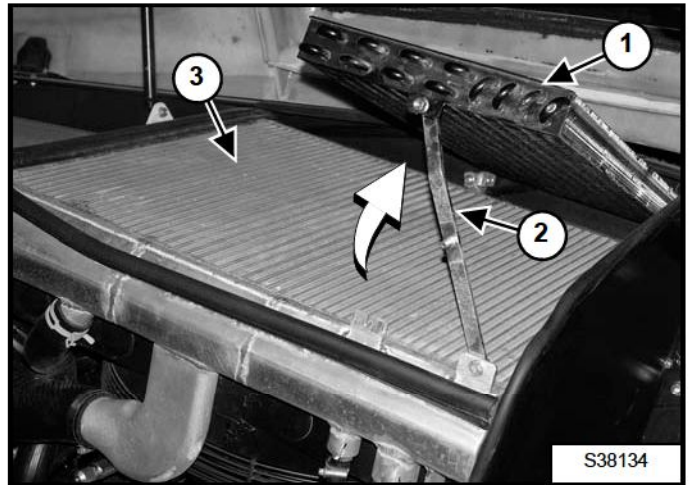

Raise the condenser (Item 1) (if equipped) and keep in position by installing the rod (Item 2) [Figure 10-70-2] in the condenser mount.

Use low air pressure or water pressure to clean the top of the cooler (Item 3) [Figure 10-70-2]. Be careful not to damage fins.

NOTE: The cooler is a combined radiator, intercooler and hydraulic fluid cooler.

NOTE: When cleaning with water, **DO NOT** aim the waterjet directly toward the battery.

Dealer Copy -- Not for Resale

ENGINE COOLING SYSTEM (CONT'D)

Checking Level

Stop the engine and allow the engine to cool. Open the engine cover. (See Opening And Closing on Page 10-160-1.)

Figure 10-70-3

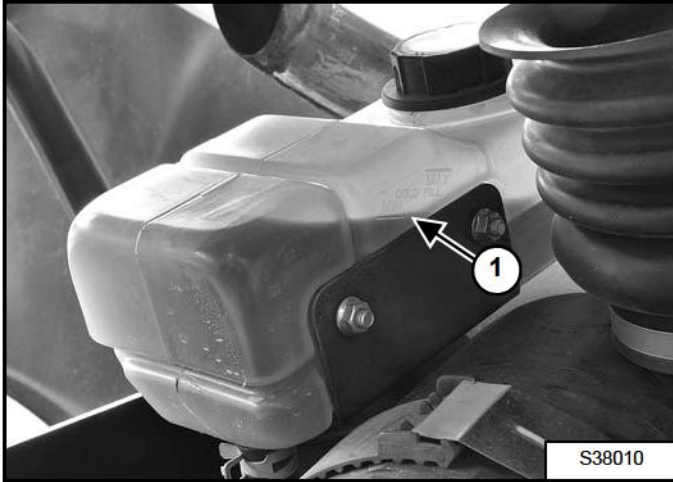

Check coolant level using the level markers (Item 1) [Figure 10-70-3] on the tank. Coolant must be between MIN and MAX level markers when the engine is cold.

NOTE: Always check coolant level before operating the machine. Lack of engine coolant will result in engine damage.

NOTE: The cooling system is factory filled with ethylene glycol (EG) coolant. **DO NOT** mix ethylene glycol with propylene glycol.

Use a refractometer to check the condition of ethylene glycol in your cooling system.

Add premixed coolant to the reservoir if the coolant level is low. (See Fluid Capacities on Page SPEC-10-4.)

Close the engine cover.

IMPORTANT

AVOID ENGINE DAMAGE

Always use the correct ratio of water to antifreeze.

Too much antifreeze reduces cooling system efficiency and may cause serious premature engine damage.

Too little antifreeze reduces the additives which protect the internal engine components; reduces the boiling point and freeze protection of the system.

Always add a premixed solution. Adding full strength concentrated coolant can cause serious premature engine damage.

I-2124-0497



Suggest:

If the above button click is invalid.

Please download this document first, and then click the above link to download the complete manual.

Thank you so much for reading

ENGINE COOLING SYSTEM (CONT'D)

Removing And Replacing The Coolant

See the SERVICE SCHEDULE for correct service intervals. (See SERVICE SCHEDULE on Page 10-50-1.)

Stop the engine. Open the engine cover. (See Opening And Closing on Page 10-160-1.)

Figure 10-70-4

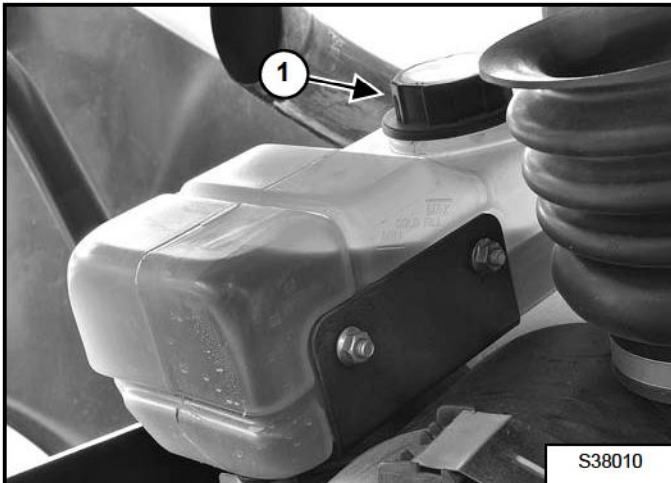

When the engine is cool, remove the coolant fill cap (Item 1) [Figure 10-70-4].

Figure 10-70-5

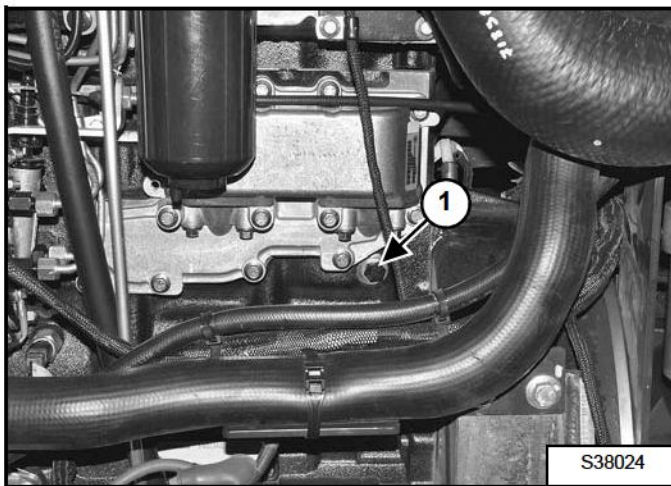

Remove the engine block drain plug (Item 1) and drain all of the coolant into a container. Install and tighten the engine block drain plug (Item 1) [Figure 10-70-5]. Recycle or dispose of used coolant in an environmentally safe manner.

Add premixed coolant to the coolant tank until the coolant level reaches the MIN marker on the tank. Install the the coolant fill cap (Item 1) [Figure 10-70-4].

Follow these steps when using concentrated coolant instead of a ready-to-use premix:

- Use a separate container to mix the coolant.
- The correct mixture proportions to provide a -37°C (-34°F) freeze protection are 50% water and 50% ethylene glycol. As example to get 8 L OR 2 U.S. gal of mixture, mix 4 L ethylene glycol with 4 L of water OR 1 U.S. gal ethylene glycol with 1 U.S. gal of water.
- Add premixed coolant to the coolant tank until the coolant level reaches the lower marker on the tank (Item 1) [Figure 10-70-3].

Run the engine until it is at operating temperature. Stop the engine. Check the coolant level when cool. Add coolant as needed.

Close the engine cover.

IMPORTANT

AVOID ENGINE DAMAGE

Always use the correct ratio of water to antifreeze.

Too much antifreeze reduces cooling system efficiency and may cause serious premature engine damage.

Too little antifreeze reduces the additives which protect the internal engine components; reduces the boiling point and freeze protection of the system.

Always add a premixed solution. Adding full strength concentrated coolant can cause serious premature engine damage.

I-2124-0497

Dealer Copy -- Not for Resale

<https://www.ebooklibonline.com>

Hello dear friend!

Thank you very much for reading.

Enter the link into your browser.

The full manual is available for immediate download.

<https://www.ebooklibonline.com>