



Bobcat®

Service Manual

TL26.60(D)(H)A, TL26.60(D)(H)B, TL30.60(D)(H)A, TL30.60(D)(H)B Telescopic Handler

(TL30.60DA) S/N B3YE11001 & Above
(TL26.60DA) S/N B3YG11001 & Above
(TL30.60HA) S/N B3Z911001 & Above
(TL26.60HA) S/N B3ZJ11001 & Above

(TL30.60DB) S/N B3YD11001 & Above
(TL26.60DB) S/N B3YF11001 & Above
(TL30.60HB) S/N B3Z811001 & Above
(TL26.60HB) S/N B3ZH11001 & Above

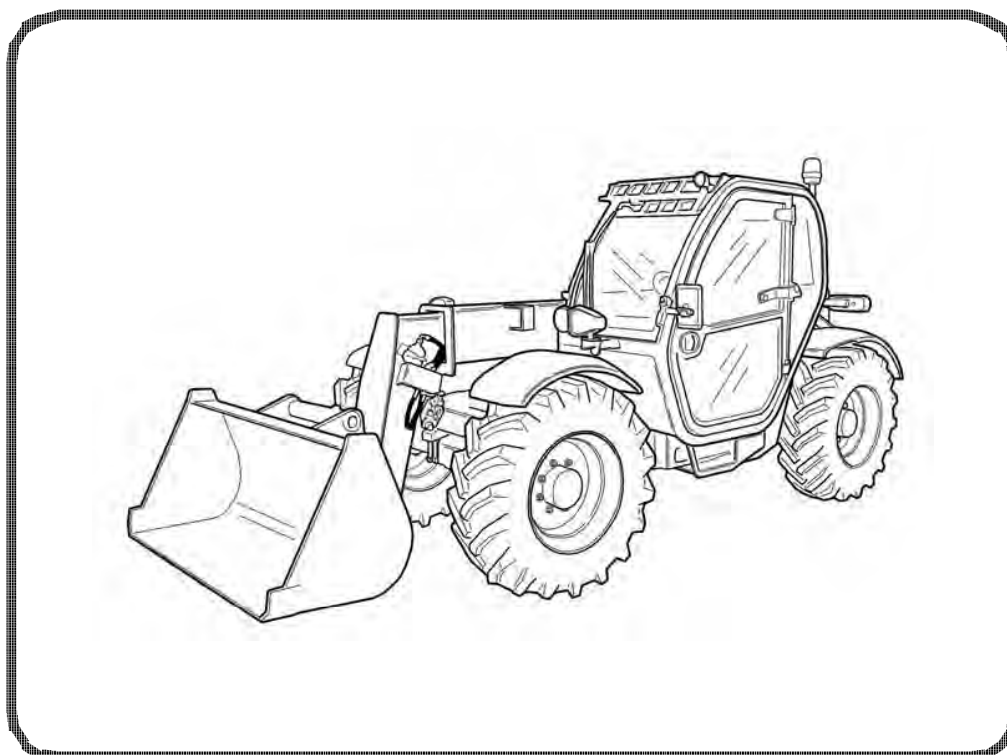

MAINTENANCE SAFETY



WARNING

Instructions are necessary before operating or servicing machine. Read and understand the Operation & Maintenance Manual, Operator's Handbook and signs (decals) on machine. Follow warnings and instructions in the manuals when making repairs, adjustments or servicing. Check for correct function after adjustments, repairs or service. Untrained operators and failure to follow instructions can cause injury or death.

W-2003-0807

CORRECT

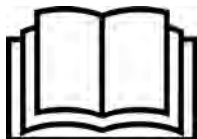

P-90216

- ⚠ Never service the Bobcat telescopic handler without instructions.



Safety Alert Symbol: This symbol with a warning statement, means: "Warning, be alert! Your safety is involved!" Carefully read the message that follows.

CORRECT

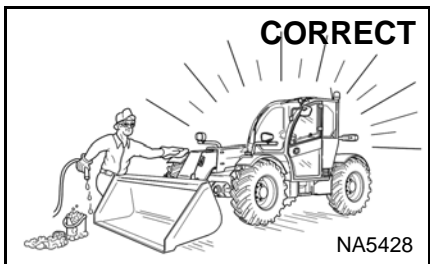

NA5428

- ⚠ Cleaning and maintenance are required daily.

WRONG

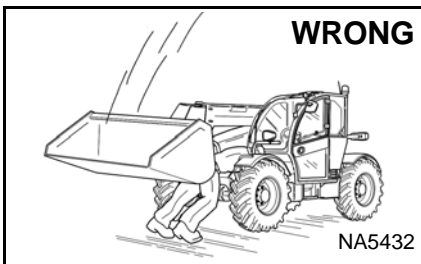

NA5432

- ⚠ Disconnecting or loosening any hydraulic tubeline, hose, fitting, component or a part failure can cause boom to drop. Do not go under boom when raised unless supported by an approved boom stop. Replace if damaged.

WRONG

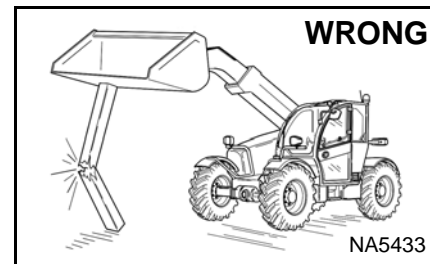

NA5433

- ⚠ Never work on telescopic handler with boom up unless boom is held by an approved boom stop. Replace if damaged.
- ⚠ Never modify equipment or add attachments not approved by Bobcat Company.

WRONG

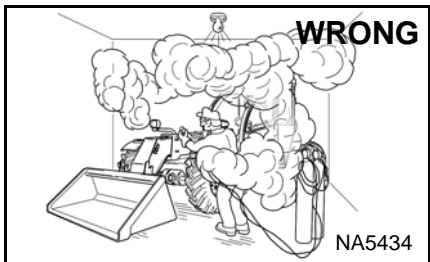

NA5434

- ⚠ Have good ventilation when welding or grinding painted parts.
- ⚠ Wear dust mask when grinding painted parts. Toxic dust and gas can be produced.
- ⚠ Avoid exhaust fume leaks which can kill without warning. Exhaust system must be tightly sealed.

WRONG

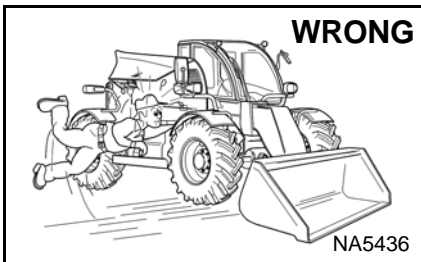

NA5436

- ⚠ Keep body, jewelry and clothing away from moving parts, electrical contact, hot parts and exhaust.
- ⚠ Wear eye protection to guard from battery acid, compressed springs, fluids under pressure and flying debris when engines are running or tools are used. Use eye protection approved for type of welding.

WRONG



B-6589

- ⚠ Lead-acid batteries produce flammable and explosive gases.
- ⚠ Keep arcs, sparks, flames and lighted tobacco away from batteries.
- ⚠ Batteries contain acid which burns eyes or skin on contact. Wear protective clothing. If acid contacts body, flush well with water. For eye contact flush well and get immediate medical attention.

Maintenance procedures which are given in the Operation & Maintenance Manual can be performed by the owner/operator without any specific technical training. Maintenance procedures which are **not** in the Operation & Maintenance Manual must be performed **ONLY BY QUALIFIED BOBCAT SERVICE PERSONNEL**. Always use genuine Bobcat replacement parts.

CONTENTS

CONTENTS	1-03
FOREWORD	1-05
SAFETY AND MAINTENANCE	10-01
HYDRAULIC SYSTEM	20-01
HYDROSTATIC SYSTEM	30-01
DRIVE SYSTEM	40-01
MAINFRAME	50-01
ELECTRICAL SYSTEM AND ANALYSIS	60-01
ENGINE SERVICE	70-01
HEATING, VENTILATION, AIR CONDITIONING (HVAC)	80-01
SPECIFICATIONS	SPEC-01
ALPHABETICAL INDEX	INDEX-01

<https://www.ebooklibonline.com>

Hello dear friend!

Thank you very much for reading.

Enter the link into your browser.

The full manual is available for immediate download.

<https://www.ebooklibonline.com>



FOREWORD

FOREWORD	1-7
SAFETY INSTRUCTIONS	1-9
Safe Operation Is The Operator's Responsibility	1-9
Safe Operation Needs A Qualified Operator	1-9
Avoid Silica Dust	1-10
Dismantling And Disposal	1-10
FIRE PREVENTION	1-11
Maintenance	1-11
Operation	1-11
Electrical	1-11
Hydraulic System	1-11
Fueling	1-11
Starting	1-11
Welding And Grinding	1-12
Fire Extinguishers	1-12
SERIAL NUMBER LOCATION	1-13
Telescopic Handler Serial Number	1-13
Engine Serial Number	1-13
Other Serial Numbers	1-14
DELIVERY REPORT	1-14
BOBCAT TELESCOPIC HANDLER IDENTIFICATION	1-15

FOREWORD

This manual is for the Bobcat telescopic handler mechanic. It provides necessary servicing and adjustment procedures for the Bobcat telescopic handler and its component parts and systems. Refer to the Operation & Maintenance Manual for operating instructions, starting procedure, daily checks, etc.

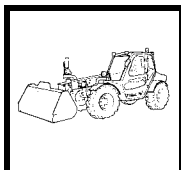
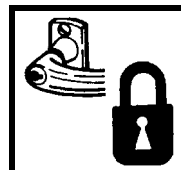
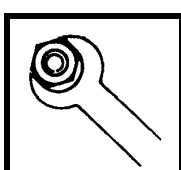
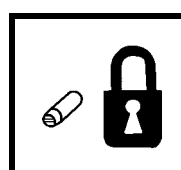
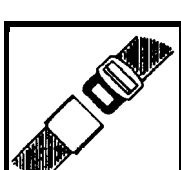
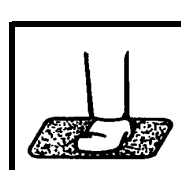
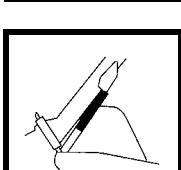
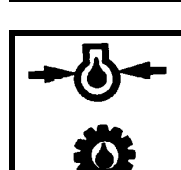
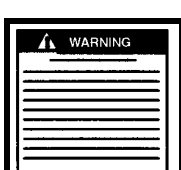
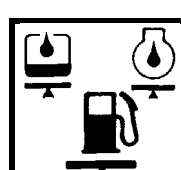
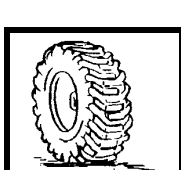
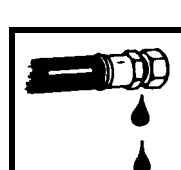
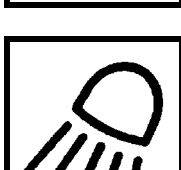
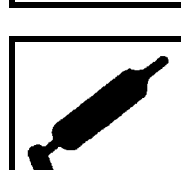
A general inspection of the following items must be made after the telescopic handler has had service or repair:

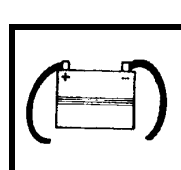
- | | | | |
|---|---|---|---|
| 1. Check that ROPS/FOPS (Including right side window) is in good condition and is not modified. |  | 9. Enclosure door latches must open and close freely. |  |
| 2. Check that ROPS mounting hardware is tightened and is Bobcat approved. |  | 10. Attachment locking pins must function correctly and be in good condition. |  |
| 3. The seat belt must be correctly installed, functional and in good condition. |  | 11. Safety treads must be in good condition. |  |
| 4. Check boom support device, replace if damaged. |  | 12. Check for correct function of indicator lamps and gauges. |  |
| 5. Machine signs must be legible and in the correct location. |  | 13. Check hydraulic fluid level, engine oil level and fuel supply. |  |
| 6. Check tires for wear and pressure. Use only approved tires. |  | 14. Inspect for fuel, oil or hydraulic fluid leaks. |  |
| 7. Check for correct function of the work lights. |  | 15. Lubricate the telescopic handler. |  |
| 8. The parking brake must function correctly. |  | 16. Check the condition of the battery and cables. |  |

FW TLS EMEA-0411 SM

17. Inspect the air cleaner for damage or leaks. Check the condition of the element.



18. Check the electrical charging system.

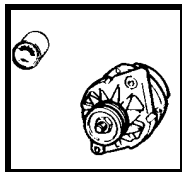

19. Inspect for loose or broken parts or connections.

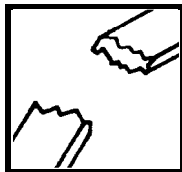

20. Operate the telescopic handler and check all functions.

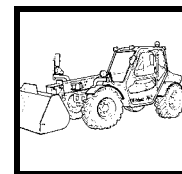

21. Check for any field modification not completed.



22. Recommend to the owner that all necessary corrections be made before the machine is returned to service.

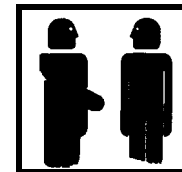

SAFETY INSTRUCTIONS

Safe Operation Is The Operator's Responsibility



Operator must have instructions before operating the machine. Untrained operators can cause injury or death.

W-2001-0502



This notice identifies procedures which must be followed to avoid damage to the machine.

I-2019-0284



The signal word DANGER on the machine and in the manuals indicates a hazardous situation which, if not avoided, will result in death or serious injury.

D-1002-1107



The signal word WARNING on the machine and in the manuals indicates a potentially hazardous situation which, if not avoided, could result in death or serious injury.

W-2044-1107

The telescopic handler and attachment must be in good operating condition before use.

Check all of the items on the Bobcat Service Schedule Decal under the 8-10 hour column or as shown in the Operation & Maintenance Manual.

Safe Operation Needs A Qualified Operator

For an operator to be qualified, he or she must not use drugs or alcoholic drinks which impair alertness or coordination while working. An operator who is taking prescription drugs must get medical advice to determine if he or she can safely operate a machine.

A Qualified Operator Must Do The Following:

Understand the Written Instructions, Rules and Regulations

- The written instructions from Bobcat Company include the Delivery Report, Operation & Maintenance Manual, Operator's Handbook and machine signs (decals).
- Check the rules and regulations at your location. The rules may include an employer's work safety requirements. For driving on public roads, the machine must be equipped as stipulated by the local regulations authorising operation on public roads in your specific country. Regulations may identify a hazard such as a utility line.
- For operating the machine, some countries require an operator license. Check the regulations at your location.

Have Training with Actual Operation

- Operator training must consist of a demonstration and verbal instruction. This training is given by your Bobcat dealer before the product is delivered.
- The new operator must start in an area without bystanders or structures and use all the controls until he or she can operate the machine and attachment safely under all conditions of the work area. Always fasten seat belt before operating.

Know the Work Conditions

- Know the weight of the materials being handled. Avoid exceeding the Rated Load Capacity of the machine (as indicated on the Load Capacity Charts). Material which is very dense will be heavier than the same volume of less dense material. Reduce the size of load if handling dense material.
- The operator must know any prohibited uses or work areas, for example, he or she needs to know about excessive slopes.
- Know the location of any underground lines.
- Wear tight fitting clothing. Always wear safety glasses when doing maintenance or service. Safety glasses, respiratory equipment, hearing protection or Front Window Guard are required for some work. See your Bobcat dealer about Bobcat Safety Equipment.

SI TH EMEA-1015 SM

SAFETY INSTRUCTIONS (CONT'D)

Safe Operation Needs A Qualified Operator (Cont'd)

Where overhead power lines are present in the operating area, ensure sufficient clearance between the nearest of these lines and any part of the machine.

VOLTAGE	MINIMUM DISTANCE
up to 50 kV	3 m (10 ft)
beyond 50 kV	5 m (16.5 ft)

The operator must survey his / her field of vision when operating the telescopic handler. Adjust mirrors to obtain the best visibility. Clean mirrors every day and more often when necessary. Immediately replace any broken or damaged mirrors. If a suspended load or the resulting boom geometry blocks the vision of the operator alternative carrying means must be considered.

The operator must know the wind speed. Do not use the telescopic handler with wind speeds over 12,5 m/s (28 mph).

Avoid Silica Dust



Cutting or drilling concrete containing sand or rock containing quartz may result in exposure to silica dust. Use a respirator, water spray or other means to control dust.

Dismantling And Disposal

On the completion of its useful life, the machine and its parts shall be disposed of in an environmental friendly manner. Please contact your local dealer. Parts of the machine can be remanufactured like the engine depending on its age and condition, or recycled like metals, plastics, rubbers and glasses. Respect the environment and dispose of waste properly. Worn or damaged parts shall not be left in the environment. Oils, brake fluid, cooling refrigerants, batteries and cells shall be disposed of in a proper manner through your local dealer or recycling center.

FIRE PREVENTION



Maintenance

The machine and some attachments have components that are at high temperatures under normal operating conditions. The primary source of high temperatures is the engine and exhaust system. The electrical system, if damaged or incorrectly maintained, can be a source of arcs or sparks.

Flammable debris (leaves, straw, etc.) must be removed regularly. If flammable debris is allowed to accumulate, it can cause a fire hazard. Clean often to avoid this accumulation. Flammable debris in the engine compartment is a potential fire hazard.

The operator's area, engine compartment and engine cooling system must be inspected every day and cleaned if necessary to prevent fire hazards and overheating.

All fuels, most lubricants and some coolants mixtures are flammable. Flammable fluids that are leaking or spilled onto hot surfaces or onto electrical components can cause a fire.

Operation

Do not use the machine where exhaust, arcs, sparks or hot components can contact flammable material, explosive dust or gases.

Electrical



Check all electrical wiring and connections for damage. Keep the battery terminals clean and tight. Repair or replace any damaged part or wires that are loose or frayed.

Battery gas can explode and cause serious injury. Use the procedure in the Operation & Maintenance Manual for connecting the battery and for jump starting. Do not jump start or charge a frozen or damaged battery. Keep any open flames or sparks away from batteries. Do not smoke in battery charging area.

Hydraulic System

Check hydraulic tubes, hoses and fittings for damage and leakage. Never use open flame or bare skin to check for leaks. Hydraulic tubes and hoses must be properly routed and have adequate support and secure clamps. Tighten or replace any parts that show leakage.

Always clean fluid spills. Do not use petrol or diesel fuel for cleaning parts. Use commercial non-flammable solvents.

Fueling



Stop the engine and let it cool before adding fuel. No smoking! Do not refuel a machine near open flames or sparks. Fill the fuel tank outdoors.

Ultra Low Sulfur Diesel (ULSD) poses a greater static ignition hazard than earlier diesel formulations with higher Sulfur content. Avoid death or serious injury from fire or explosion. Consult with your fuel or fuel system supplier to ensure the delivery system is in compliance with fueling standards for proper grounding and bonding practices.

Starting

Do not use ether or starting fluids on any engine that has glow plugs. These starting aids can cause explosion and injure you or bystanders.

Use the procedure in the Operation & Maintenance Manual for connecting the battery and for jump starting.

FIRE PREVENTION (CONT'D)

Welding And Grinding

Always clean the machine and attachment, disconnect the battery, and disconnect the wiring from the Bobcat controllers before welding. Cover rubber hoses, battery and all other flammable parts. Keep a fire extinguisher near the machine when welding.

Have good ventilation when grinding or welding painted parts. Wear dust mask when grinding painted parts. Toxic dust or gas can be produced.

Dust generated from repairing non-metallic parts such as hoods, fenders or covers can be flammable or explosive. Repair such components in a well ventilated area away from open flames or sparks.

Fire Extinguishers

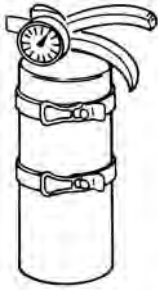

Know where fire extinguishers and first aid kits are located and how to use them. Inspect the fire extinguisher and service the fire extinguisher regularly. Obey the recommendations on the instructions plate.

SERIAL NUMBER LOCATION

Always use the serial number of the telescopic handler when requesting service information or when ordering parts.

If any serial number plate is damaged, contact your Bobcat dealer.

Telescopic Handler Serial Number

Figure 1

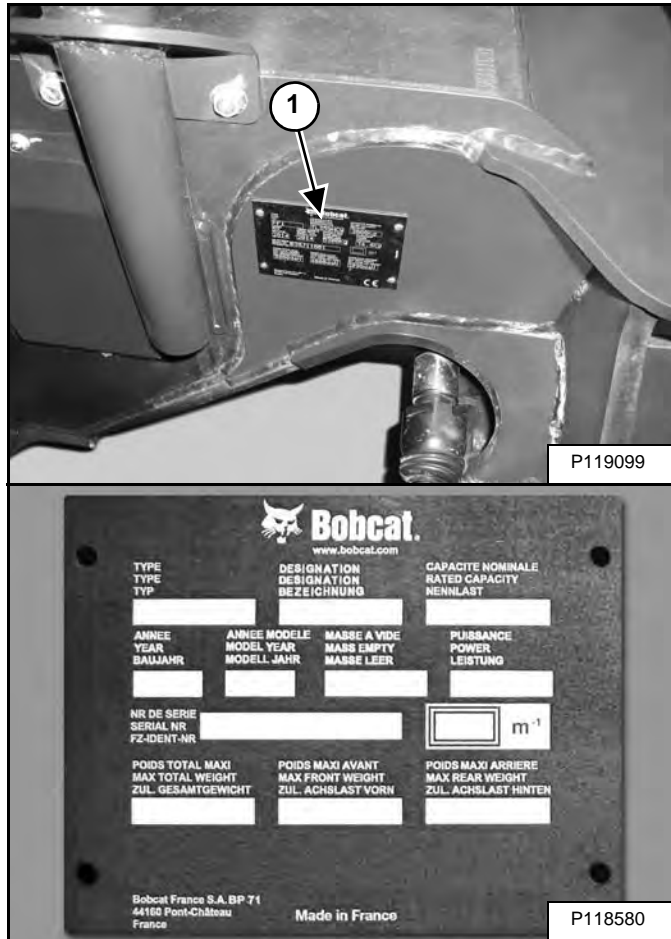

The telescopic handler serial number plate (Item 1) is located on the right side of the chassis in front [Figure 1].

Explanation of telescopic handler serial number:

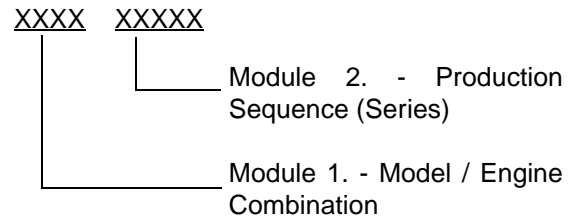

1. The four digit Model / Engine Combination Module number identifies the model number and engine combination.

2. The five digit Production Sequence Number identifies the order in which the telescopic handler is produced.

Engine Serial Number

Figure 2

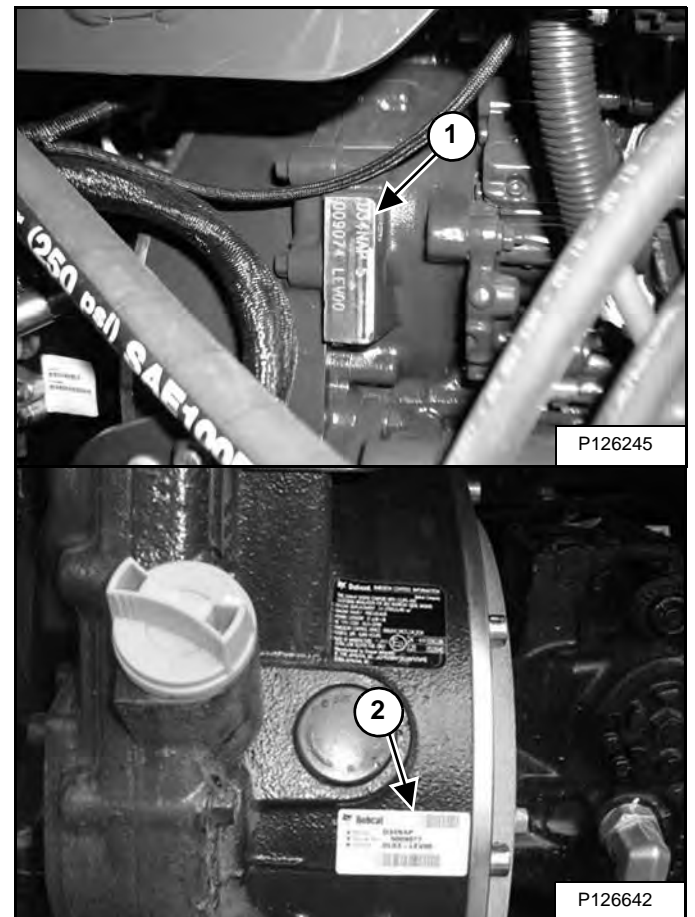

The engine serial number can be found on the engine cylinder block (Item 1) and on the engine rating plate (Item 2) [Figure 2] near the flywheel in front of you when opening the engine cover. Always use the full number (type + number) when ordering replacement parts.

SERIAL NUMBER LOCATION (CONT'D)

Other Serial Numbers

Other components can also have serial numbers and an identification plate. Always use these serial numbers when ordering parts.

DELIVERY REPORT

Figure 3

The diagram shows a delivery report form with the following layout:

- Top right: A box titled "DELIVERY REPORT" containing a grid of lines for text entry.
- Below the top right box: A box titled "WARNING" containing a grid of lines.
- Main body: A large grid of lines for text entry.
- Bottom right: A small box containing the text "B-16315".

The delivery report [Figure 3] contains a list of items that must be explained or shown to the owner or operator by the dealer when the Bobcat telescopic handler is delivered.

The delivery report must be reviewed and signed by the owner or operator and the dealer.

BOBCAT TELESCOPIC HANDLER IDENTIFICATION

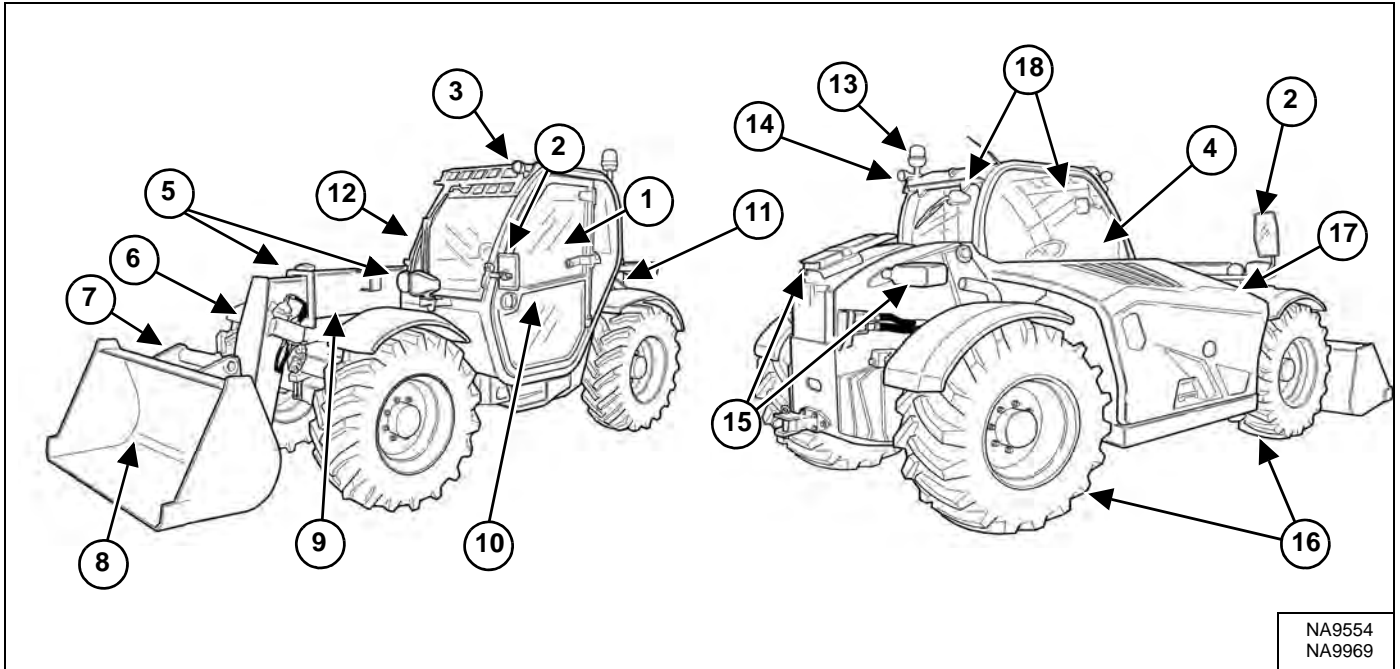

NA9554
NA9969

ITEM	DESCRIPTION	ITEM	DESCRIPTION
1	Operation & Maintenance Manual and Operator's Handbook	10	Seat Belt
2	Mirrors	11	Boom Stop [A]
3	Work Lights	12	Operator Cab (ROPS and FOPS) [C]
4	Load Capacity Charts	13	Rotating Beacon [A]
5	Front Lights	14	Rear Work Light
6	Telescoping Boom	15	Tail Lights and Direction Signals
7	Boom Head	16	Tires [D]
8	Attachment Carrier [B]	17	Engine Cover
9	Boom	18	Rear / Front Interior Mirror

[A] Optional or Field Accessory. (Not Standard Equipment).

[B] Attachments - Several different attachments are available for the Bobcat telescopic handler.

[C] ROPS, FOPS - Roll-Over Protective Structure, per ISO 3471, and Falling-Object Protective Structure per ISO 3449, Level II.

[D] TIRES - Standard tires are shown. Several different tire styles and sizes are available for the Bobcat telescopic handler.

SAFETY AND MAINTENANCE

LIFTING AND BLOCKING THE TELESCOPIC HANDLER	10-10-1
Procedure	10-10-1
OPERATOR CAB	10-20-1
Description	10-20-1
Cab Door	10-20-1
Cab Door Window	10-20-2
Rear Cab Window	10-20-3
Cab Light	10-20-3
TRANSPORTING THE TELESCOPIC HANDLER ON A TRAILER	10-30-1
Loading And Unloading	10-30-1
Fastening	10-30-1
TOWING THE TELESCOPIC HANDLER	10-40-1
Procedure	10-40-1
SERVICE SCHEDULE	10-50-1
Maintenance Intervals	10-50-1
AIR CLEANER SERVICE	10-60-1
Replacing Filter Elements	10-60-1
ENGINE COOLING SYSTEM	10-70-1
Cleaning	10-70-1
Checking Level	10-70-2
Removing And Replacing The Coolant	10-70-2
FUEL SYSTEM	10-80-1
Fuel Specifications	10-80-1
Biodiesel Blend Fuel	10-80-1
Filling The Fuel Tank	10-80-2
Fuel Filter	10-80-2
Removing Air From The Fuel System	10-80-4
ENGINE LUBRICATION SYSTEM	10-90-1
Checking And Adding Engine Oil	10-90-1
Engine Oil Chart	10-90-1
Removing And Replacing Oil And Filter	10-90-2
HYDRAULIC / HYDROSTATIC SYSTEM	10-100-1
Checking And Adding Fluid	10-100-1
Removing And Replacing Hydraulic Fluid	10-100-2
Removing And Replacing Hydraulic / Hydrostatic Filters	10-100-3
Fill / Breather Cap	10-100-5

AXLES (FRONT AND REAR)	10-110-1
Checking And Adding Oil (Planetary Carrier)	10-110-1
Removing And Replacing Oil (Planetary Carrier)	10-110-1
Checking And Adding Oil (Rear Differential)	10-110-2
Removing And Replacing Oil (Rear Differential)	10-110-2
Checking And Adding Oil (Front Differential)	10-110-3
Removing And Replacing Oil (Front Differential)	10-110-3
Checking And Adding Oil (Reduction Box)	10-110-4
Removing And Replacing Oil (Reduction Box)	10-110-4
LUBRICATING THE TELESCOPIC HANDLER	10-120-1
Lubrication Locations	10-120-1
ATTACHMENT CARRIER	10-130-1
Inspection And Maintenance	10-130-1
TIRE MAINTENANCE	10-140-1
Wheel Nuts	10-140-1
Rotating	10-140-1
Wheel Replacement	10-140-1
Mounting	10-140-2
Pressure	10-140-2
APPROVED BOOM STOP	10-150-1
Installing The Approved Boom Stop	10-150-1
Removing The Approved Boom Stop	10-150-1
ENGINE COVER	10-160-1
Opening And Closing	10-160-1
STOPPING THE ENGINE AND LEAVING THE TELESCOPIC HANDLER	10-170-1
Procedure	10-170-1
EMERGENCY EXIT	10-180-1
Rear Window	10-180-1
TELESCOPIC HANDLER STORAGE AND RETURN TO SERVICE	10-190-1
Storage	10-190-1
Return To Service	10-190-1
LIFTING THE TELESCOPIC HANDLER	10-200-1
Procedure	10-200-1
REMOTE START TOOL (SERVICE TOOL) KIT - MEL1563	10-210-1
Remote Start Tool - MEL1563	10-210-1
Service Tool Harness Control - MEL1565	10-210-2
Service Tool Harness Communicator - MEL1566	10-210-3

REMOTE START TOOL (SERVICE TOOL) KIT - 7217666 10-220-1
Remote Start Tool (Service Tool) - 7022042 10-220-1
Telescopic Handler Service Tool Harness - 6689747 10-220-2
Computer Service Tool Harness - 6689746 10-220-3
Remote Start Procedure 10-220-4

LIFTING AND BLOCKING THE TELESCOPIC HANDLER

Procedure

Always park the machine on a flat, solid and level surface.



WARNING

**MACHINE FALLING OR MOVING CAN CAUSE
SERIOUS INJURY OR DEATH**

Put jackstands under the front and rear of the machine before running engine for service.

W-2718-0208

Figure 10-10-1

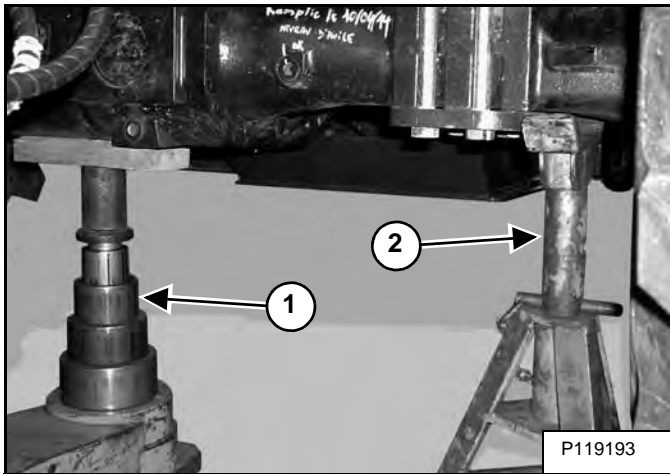

STOP the engine. Put the floor jack (Item 1) under the left side of the front axle. Lift the telescopic handler and install the first jackstand (Item 2) [Figure 10-10-1].

Figure 10-10-2

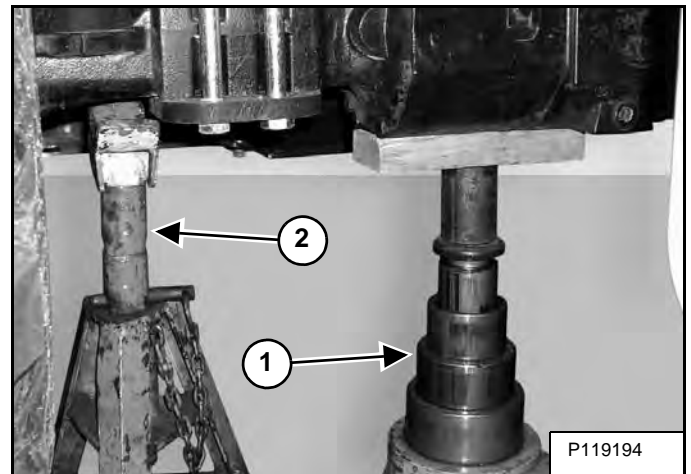

Put the floor jack (Item 1) under the right side of the front axle. Lift the telescopic handler and install the second jackstand (Item 2) [Figure 10-10-2].

Figure 10-10-3

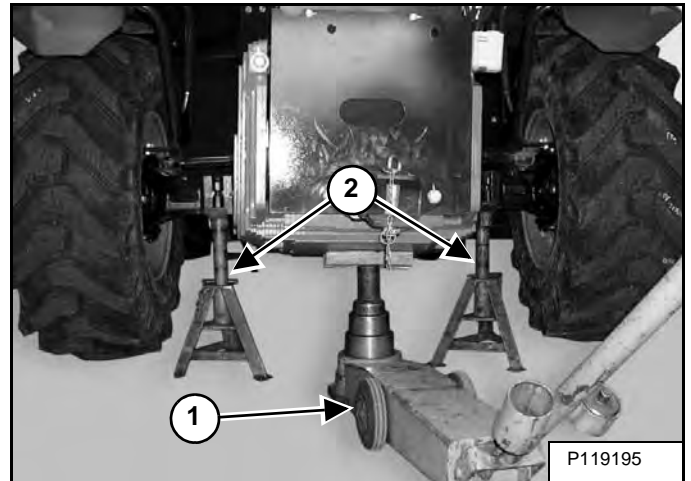

Put the floor jack (Item 1) under the center of the rear weight. Lift the telescopic handler and install jackstands (Item 2) [Figure 10-10-3].

OPERATOR CAB

Description

The Bobcat telescopic handler has an operator cab (ROPS / FOPS) as standard equipment to protect the operator. The seat belt must be worn for ROPS / FOPS protection.

Check the ROPS / FOPS cab, mounting, and hardware for damage. Never modify the ROPS / FOPS cab. Replace the cab and hardware if damaged. See your Bobcat dealer for parts.

ROPS / FOPS - Roll Over Protective Structure per ISO 3471, Falling Object Protective Structure per ISO 3449 (FOPS Level II) and OECD code 4, code 9 and code 10.

Operator cab category 1 per EN 15695-1:2009.

The operator cab does not provide protection against hazardous substances. Do not use this machine under conditions requiring protection against hazardous substances.



Never modify operator cab by welding, grinding, drilling holes or adding attachments unless instructed to do so by Bobcat Company. Do not operate without right window. Changes to the cab can cause loss of operator protection from rollover and falling objects, and result in serious injury or death.

W-2906-0211

Cab Door

Figure 10-20-1

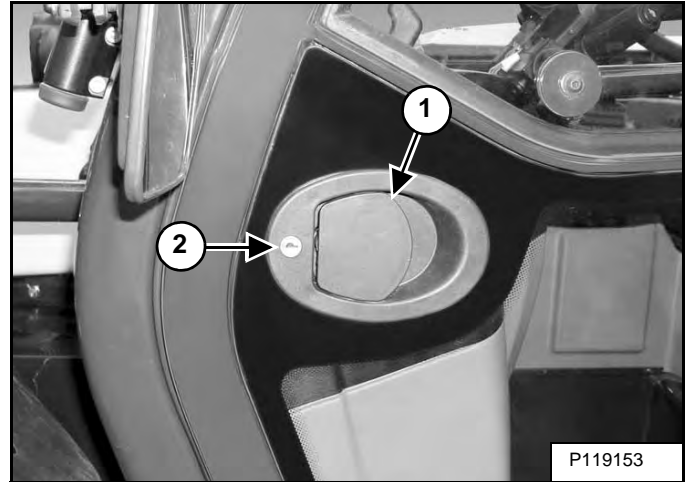
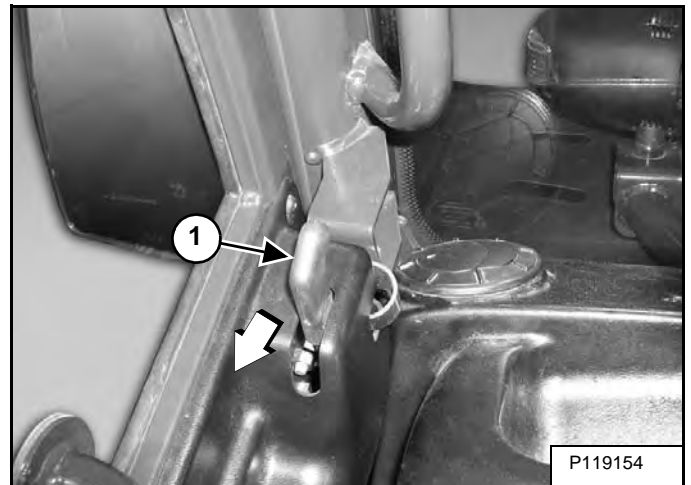

Figure 10-20-2



The cab door can be opened from the outside of the cab using the latch (Item 1) [Figure 10-20-1] and opened from the inside of the cab when you pull the lever (Item 1) [Figure 10-20-2] back (as shown).

The cab door can be locked (Item 2) [Figure 10-20-1] with the same key as the starter switch.



Suggest:

If the above button click is invalid.

Please download this document

first, and then click the above link

to download the complete manual.

Thank you so much for reading

OPERATOR CAB (CONT'D)

Cab Door Window

Figure 10-20-3

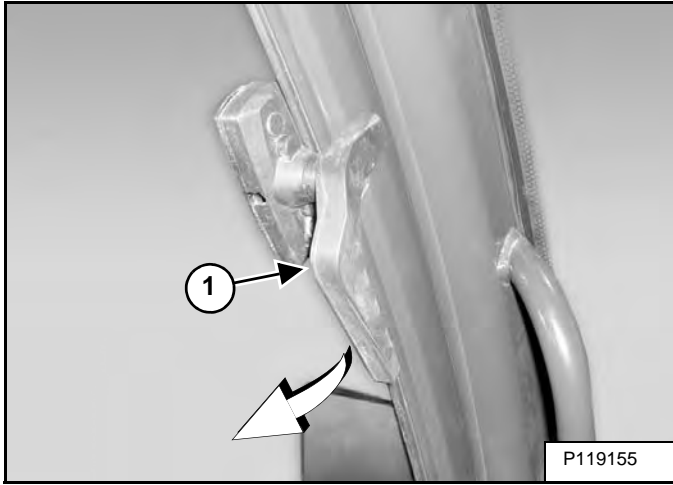

Turn the handle (Item 1) [Figure 10-20-3] (as shown) to unlock the window. Push the window fully open until it latches against the cab.

Figure 10-20-4

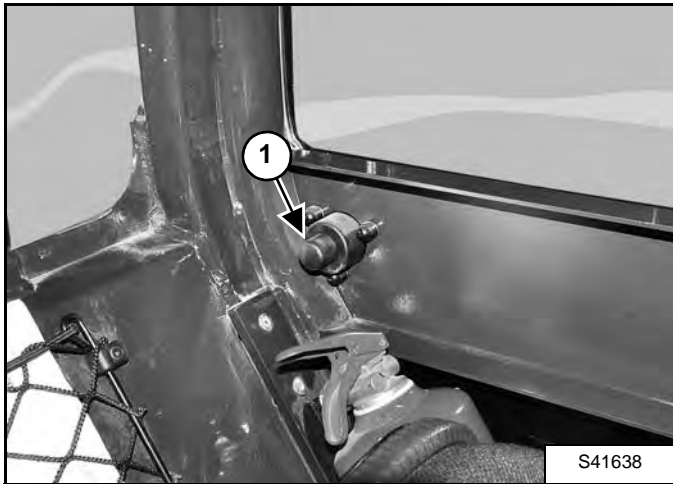

Push the knob (Item 1) [Figure 10-20-4] inside the cab to disengage the latch and close the window.

Figure 10-20-5

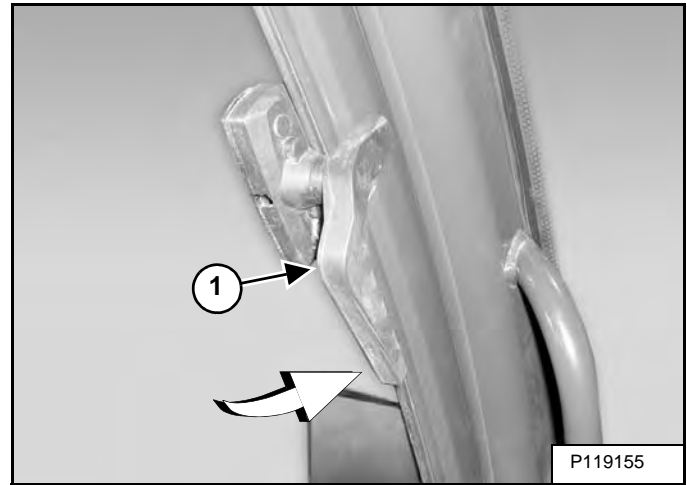

Turn the handle (Item 1) [Figure 10-20-5] back into the original position (as shown) to lock the window.

<https://www.ebooklibonline.com>

Hello dear friend!

Thank you very much for reading.

Enter the link into your browser.

The full manual is available for immediate download.

<https://www.ebooklibonline.com>