



# Bobcat®

---

## Service Manual

### T35100, T35100S, T35100L, T35100SL, T35120L, T35120SL

## Telescopic Handler

---

T35100: S/N A8HD11001 & Above  
T35100L: S/N A8GW11001 & Above  
T35100SL: S/N A8GT11001 & Above  
T35120L: S/N A8GV11001 & Above  
T35120SL: S/N A8GJ11001 & Above

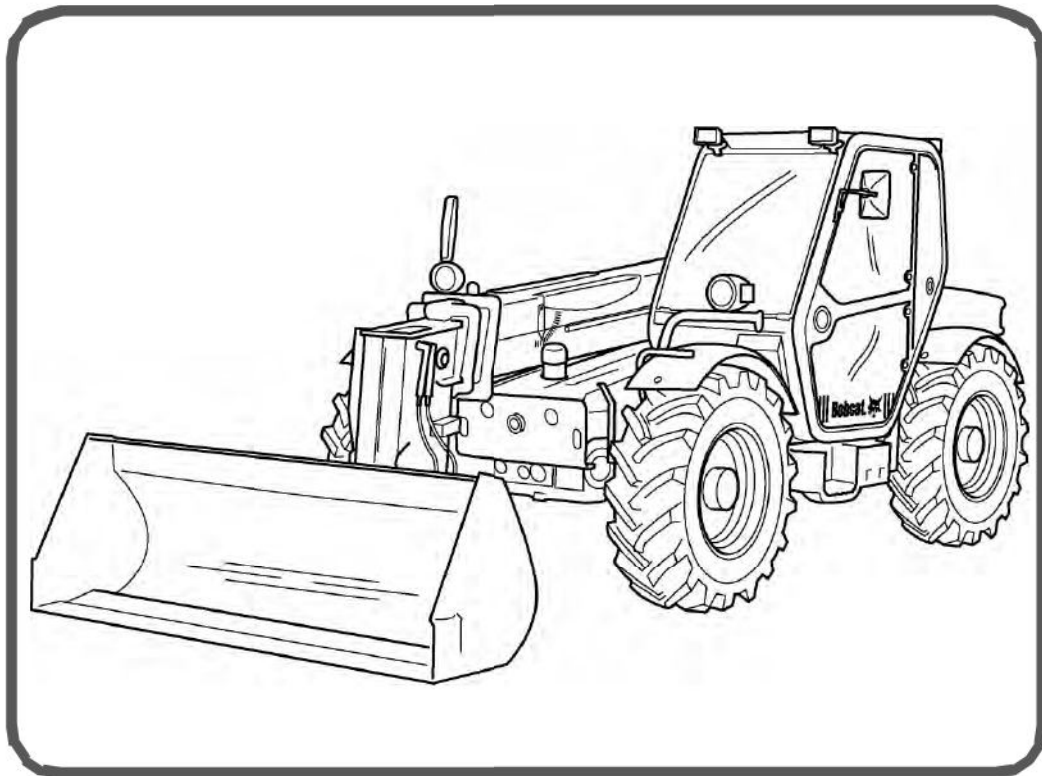

Dealer Copy -- Not for Resale



# MAINTENANCE SAFETY



## WARNING

Instructions are necessary before operating or servicing machine. Read and understand the Operation & Maintenance Manual, Operator's Handbook and signs (decals) on machine. Follow warnings and instructions in the manuals when making repairs, adjustments or servicing. Check for correct function after adjustments, repairs or service. Untrained operators and failure to follow instructions can cause injury or death.

W-2003-0807

### CORRECT

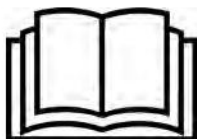

P-90216

⚠ Never service the Bobcat VersaHANDLER without instructions.



**Safety Alert Symbol:** This symbol with a warning statement, means: "Warning, be alert! Your safety is involved!" Carefully read the message that follows.

### CORRECT

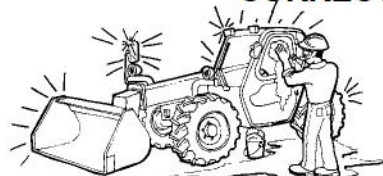

B-16082

⚠ Cleaning and maintenance are required daily.

### WRONG

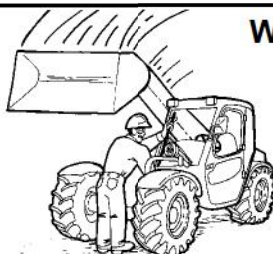

B-16080

⚠ Disconnecting or loosening any hydraulic tubeline, hose, fitting, component or a part failure can cause boom to drop. Do not go under boom when raised unless supported by an approved boom stop. Replace if damaged.

### WRONG

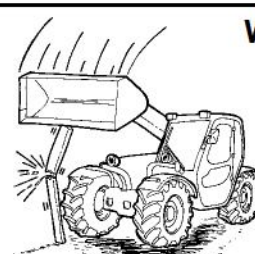

B-16079

⚠ Never work on VersaHANDLER with boom up unless boom is held by an approved boom stop. Replace if damaged.  
⚠ Never modify equipment or add attachments not approved by Bobcat Company.

### WRONG

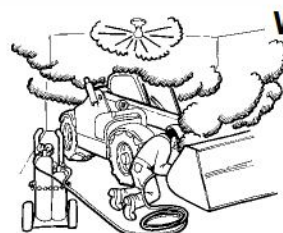

B-16081

⚠ Have good ventilation when welding or grinding painted parts.  
⚠ Wear dust mask when grinding painted parts. Toxic dust and gas can be produced.  
⚠ Avoid exhaust fume leaks which can kill without warning. Exhaust system must be tightly sealed.

### WRONG



B-16078

⚠ Keep body, jewelry and clothing away from moving parts, electrical contact, hot parts and exhaust.  
⚠ Wear eye protection to guard from battery acid, compressed springs, fluids under pressure and flying debris when engines are running or tools are used. Use eye protection approved for type of welding.

### WRONG



B-6589

⚠ Lead-acid batteries produce flammable and explosive gases.  
⚠ Keep arcs, sparks, flames and lighted tobacco away from batteries.  
⚠ Batteries contain acid which burns eyes or skin on contact. Wear protective clothing. If acid contacts body, flush well with water. For eye contact flush well and get immediate medical attention.

Dealer Copy -- Not for Resale

Maintenance procedures which are given in the Operation & Maintenance Manual can be performed by the owner/operator without any specific technical training. Maintenance procedures which are not in the Operation & Maintenance Manual must be performed **ONLY BY QUALIFIED BOBCAT SERVICE PERSONNEL**. Always use genuine Bobcat replacement parts.

MSW12-0409

## CONTENTS

SAFETY AND MAINTENANCE .....	10-01
HYDRAULIC SYSTEM .....	20-01
HYDROSTATIC SYSTEM .....	30-01
DRIVE SYSTEM .....	40-01
MAINFRAME .....	50-01
ELECTRICAL SYSTEM & ANALYSIS .....	60-01
ENGINE SERVICE .....	70-01
HEATING, VENTILATION, AIR CONDITIONING .....	80-01
SPECIFICATIONS .....	SPEC-01
ALPHABETICAL INDEX .....	INDEX-01

Dealer Copy -- Not for Resale

## FOREWORD

FOREWORD .....	1-3
SAFETY INSTRUCTIONS .....	1-5
Before Operation .....	1-5
Safe Operation Is The Operator's Responsibility .....	1-6
Safe Operation Needs A Qualified Operator .....	1-6
Avoid Silica Dust .....	1-7
FIRE PREVENTION .....	1-7
Maintenance .....	1-7
Operation .....	1-7
Electrical .....	1-7
Hydraulic System .....	1-8
Fueling .....	1-8
Starting .....	1-8
Spark Arrester Exhaust System .....	1-8
Welding And Grinding .....	1-8
Fire Extinguishers .....	1-8
SERIAL NUMBER LOCATION .....	1-9
Telescopic Handler Serial Number .....	1-9
Engine Serial Number .....	1-9
Other Serial Numbers .....	1-9
DELIVERY REPORT .....	1-10
BOBCAT TELESCOPIC HANDLER IDENTIFICATION .....	1-11

Dealer Copy -- Not for Resale

**<https://www.ebooklibonline.com>**

Hello dear friend!

Thank you very much for reading.

Enter the link into your browser.











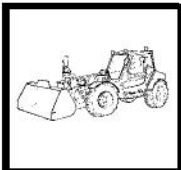

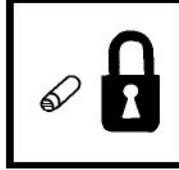
The full manual is available for immediate download.

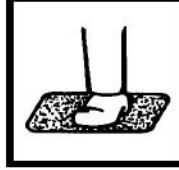
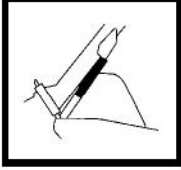
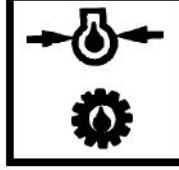
**<https://www.ebooklibonline.com>**

# FOREWORD

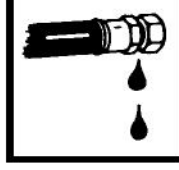
This manual is for the Bobcat telescopic handler mechanic. It provides necessary servicing and adjustment procedures for the Bobcat telescopic handler and its component parts and systems. Refer to the Operation & Maintenance Manual for operating instructions, starting procedure, daily checks, etc.

A general inspection of the following items must be made after the telescopic handler has had service or repair:

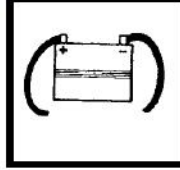
- |   |   |   |   |
|---|---|---|---|
| 1. Check that ROPS/FOPS (Including right side window) is in good condition and is not modified. |    | 9. Enclosure door latches must open and close freely.                         |    |
| 2. Check that ROPS mounting hardware is tightened and is Bobcat approved.                       |    | 10. Attachment locking pins must function correctly and be in good condition. |    |
| 3. The seat belt must be correctly installed, functional and in good condition.                 |    | 11. Safety treads must be in good condition.                                  |    |
| 4. Check boom support device, replace if damaged.   |   | 12. Check for correct function of indicator lamps and gauges.                 |   |
| 5. Machine signs must be legible and in the correct location.                                   |  | 13. Check hydraulic fluid level, engine oil level and fuel supply.            |  |
| 6. Check tires for wear and pressure. Use only approved tires.                                  |  | 14. Inspect for fuel, oil or hydraulic fluid leaks.                           |  |
| 7. Check for correct function of the work lights.   |  | 15. Lubricate the Telescopic Handler.   |  |
| 8. The parking brake must function correctly.   |  | 16. Check the condition of the battery and cables.                            |  |

Dealer Copy -- Not for Resale

17. Inspect the air cleaner for damage or leaks. Check the condition of the element.

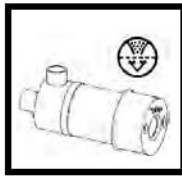

20. Operate the Telescopic Handler and check all functions.

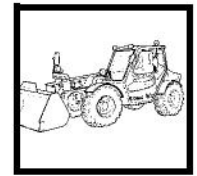

18. Check the electrical charging system.

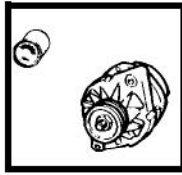

21. Check for any field modification not completed.



19. Inspect for loose or broken parts or connections.

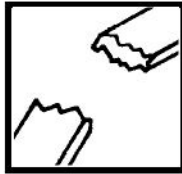

22. Recommend to the owner that all necessary corrections be made before the machine is returned to service.



## SAFETY INSTRUCTIONS



### Safety Alert Symbol

This symbol with a warning statement means: "Warning, be alert! Your safety is involved!" Carefully read the message that follows.



## WARNING

Instructions are necessary before operating or servicing machine. Read and understand the Operation & Maintenance Manual, Operator's Handbook and signs (decals) on machine. Follow warnings and instructions in the manuals when making repairs, adjustments or servicing. Check for correct function after adjustments, repairs or service. Untrained operators and failure to follow instructions can cause injury or death.

W-2003-0807

## IMPORTANT

This notice identifies procedures which must be followed to avoid damage to the machine.

I-2019-0284



## DANGER

The signal word DANGER on the machine and in the manuals indicates a hazardous situation which, if not avoided, will result in death or serious injury.

D-1002-1107



## WARNING

The signal word WARNING on the machine and in the manuals indicates a potentially hazardous situation which, if not avoided, could result in death or serious injury.

W-2044-1107

The following publications provide information on the safe use and maintenance of the Bobcat machine and attachments:

- The Delivery Report is used to assure that complete instructions have been given to the new owner and that the machine is in safe operating condition.
- The Operation & Maintenance Manual delivered with the machine or attachment contains operating information as well as routine maintenance and service procedures. It is a part of the machine and can be stored in a container provided on the machine. Replacement Operation & Maintenance Manuals can be ordered from your Bobcat dealer.
- Machine signs (decals) instruct on the safe operation and care of your Bobcat machine or attachment. The signs and their locations are shown in the Operation & Maintenance Manual. Replacement signs are available from your Bobcat dealer.
- An Operator's Handbook fastened to the operator cab. It's brief instructions are convenient to the operator. The handbook is available from your dealer in an English edition or one of many other languages. See your Bobcat dealer for more information on translated versions.
- The AEM Safety Manual delivered with the machine gives general safety information.
- The Service Manual and Parts Manual are available from your dealer for use by mechanics to do shop-type service and repair work.
- The Telescopic Handler Operator Training Course is available through your local dealer or at [www.training.bobcat.com](http://www.training.bobcat.com) or [www.bobcat.com](http://www.bobcat.com). This course is intended to provide rules and practices of correct operation of the Telescopic Handler.
- The Telescopic Handler Safety Video is available from your Bobcat dealer or at [www.training.bobcat.com](http://www.training.bobcat.com) or [www.bobcat.com](http://www.bobcat.com).

The dealer and owner / operator review the recommended uses of the product when delivered. If the owner / operator will be using the machine for a different application(s) he or she must ask the dealer for recommendations on the new use.

Dealer Copy -- Not for Resale

SI VH EMEA-0409 SM

## SAFETY INSTRUCTIONS (CONT'D)



Cutting or drilling concrete containing sand or rock containing quartz may result in exposure to silica dust. Use a respirator, water spray or other means to control dust.

## FIRE PREVENTION



### Maintenance

The machine and some attachments have components that are at high temperatures under normal operating conditions. The primary source of high temperatures is the engine and exhaust system. The electrical system, if damaged or incorrectly maintained, can be a source of arcs or sparks.

Flammable debris (leaves, straw, etc.) must be removed regularly. If flammable debris is allowed to accumulate, it can cause a fire hazard. Clean often to avoid this accumulation. Flammable debris in the engine compartment is a potential fire hazard.

The operator's area, engine compartment and engine cooling system must be inspected every day and cleaned if necessary to prevent fire hazards and overheating.

All fuels, most lubricants and some coolants mixtures are flammable. Flammable fluids that are leaking or spilled onto hot surfaces or onto electrical components can cause a fire.

### Operation

Do not use the machine where exhaust, arcs, sparks or hot components can contact flammable material, explosive dust or gases.

### Electrical



Check all electrical wiring and connections for damage. Keep the battery terminals clean and tight. Repair or replace any damaged part or wires that are loose or frayed.

Battery gas can explode and cause serious injury. Use the procedure in the Operation & Maintenance Manual for connecting the battery and for jump starting. Do not jump start or charge a frozen or damaged battery. Keep any open flames or sparks away from batteries. Do not smoke in battery charging area.

SI VH EMEA-0409 SM

## FIRE PREVENTION (CONT'D)

### Hydraulic System

Check hydraulic tubes, hoses and fittings for damage and leakage. Never use open flame or bare skin to check for leaks. Hydraulic tubes and hoses must be properly routed and have adequate support and secure clamps. Tighten or replace any parts that show leakage.

Always clean fluid spills. Do not use gasoline or diesel fuel for cleaning parts. Use commercial nonflammable solvents.

### Fueling



Stop the engine and let it cool before adding fuel. No smoking! Do not refuel a machine near open flames or sparks. Fill the fuel tank outdoors.

### Starting

Do not use ether or starting fluids on any engine that has glow plugs. These starting aids can cause explosion and injure you or bystanders.

Use the procedure in the Operation & Maintenance Manual for connecting the battery and for jump starting.

### Spark Arrestor Exhaust System

The spark arrestor exhaust system is designed to control the emission of hot particles from the engine and exhaust system, but the muffler and the exhaust gases are still hot.

Check the spark arrestor exhaust system regularly to make sure it is maintained and working properly. Use the procedure in the Operation & Maintenance Manual for cleaning the spark arrestor muffler (if equipped).

## Welding And Grinding

Always clean the machine and attachment, disconnect the battery, and disconnect the wiring from the Bobcat controllers before welding. Cover rubber hoses, battery and all other flammable parts. Keep a fire extinguisher near the machine when welding.

Have good ventilation when grinding or welding painted parts. Wear dust mask when grinding painted parts. Toxic dust or gas can be produced.

Dust generated from repairing nonmetallic parts such as hoods, fenders or covers can be flammable or explosive. Repair such components in a well ventilated area away from open flames or sparks.

### Fire Extinguishers

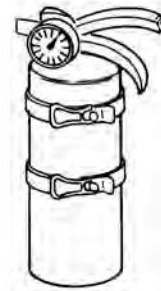

Know where fire extinguishers and first aid kits are located and how to use them. Inspect the fire extinguisher and service the fire extinguisher regularly. Obey the recommendations on the instructions plate.

Dealer Copy Not for Resale

## SERIAL NUMBER LOCATION

Always use the serial number of the telescopic handler when requesting service information or when ordering parts.

### Telescopic Handler Serial Number

Figure 1



The front, on the right side of the frame [Figure 1].

### Engine Serial Number

Figure 2

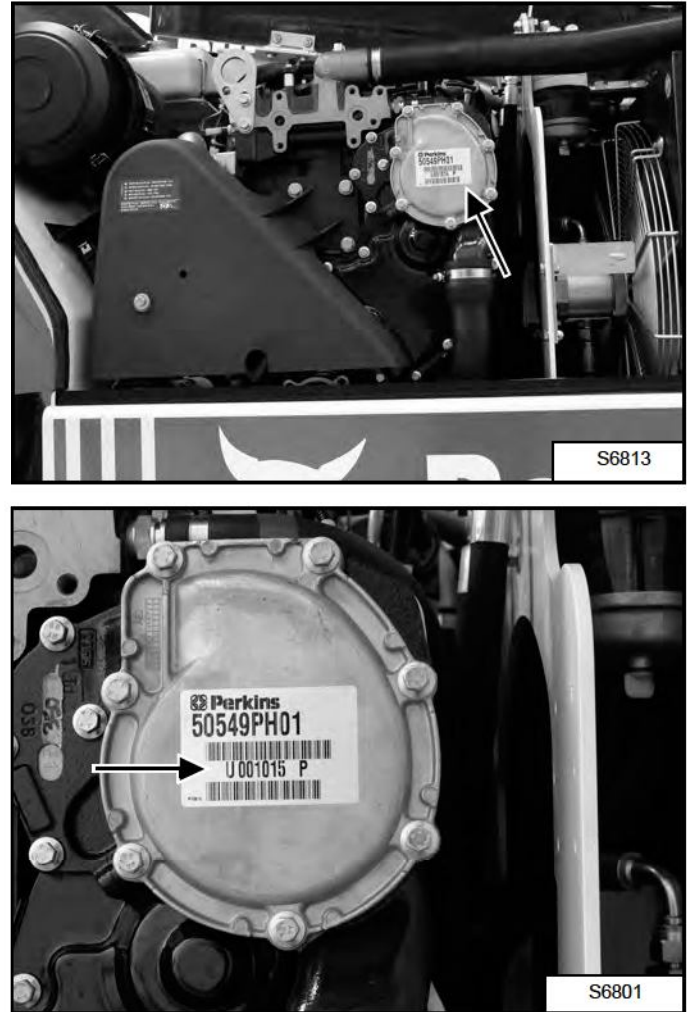

The engine serial number can be found on the water pump [Figure 2] in front of you when opening the engine cover. Always use the full number when ordering replacement parts.

### Other Serial Numbers

Some components can also have serial numbers. Always use these serial numbers when requesting parts.

Dealer Copy -- Not for Resale

# DELIVERY REPORT

Figure 3

The diagram shows a form titled "DELIVERY REPORT". The form is divided into several sections. At the top right, the title "DELIVERY REPORT" is printed. Below the title, there are several lines of text and a small table or grid. On the left side, there is a prominent box with the word "WARNING" in bold, capital letters. Below this box, there are several lines of text. At the bottom right of the form, there is a small box containing the alphanumeric code "B-16315".

The Delivery Report must be completed by the dealer and signed by the owner or operator when the telescopic handler is delivered. An explanation of the form must be given to the owner. Make sure it is complete **[Figure 3]**.

**BOBCAT TELESCOPIC HANDLER IDENTIFICATION**

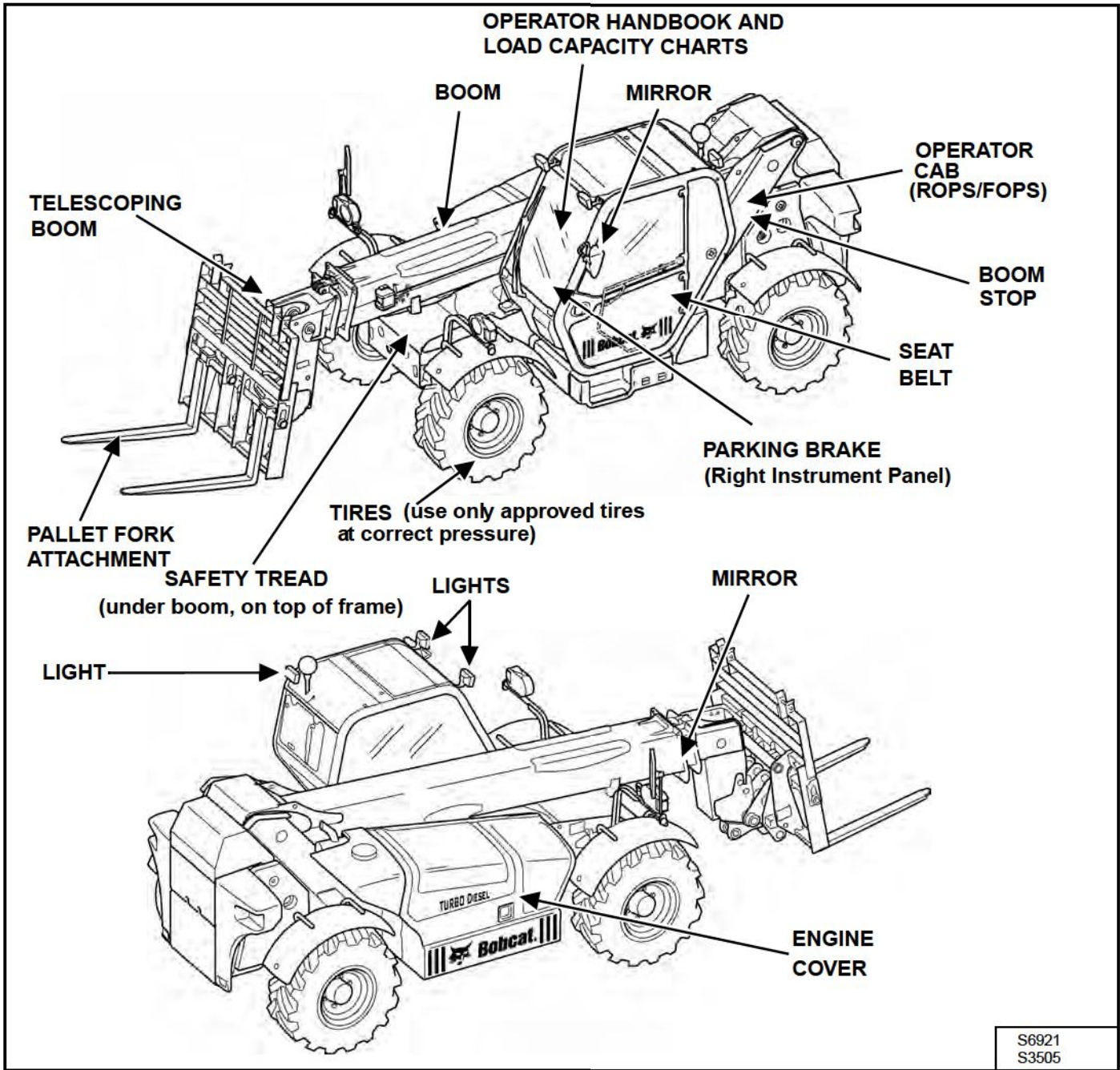

Dealer Copy -- Not for Resale

## SAFETY AND MAINTENANCE

LIFTING AND BLOCKING THE TELESCOPIC HANDLER .....	10-10-1
Procedure .....	10-10-1
OPERATOR CAB (ROPS / FOPS) .....	10-20-1
Cab Door .....	10-20-2
Cab Door Window .....	10-20-2
TRANSPORTING THE TELESCOPIC HANDLER ON A TRAILER .....	10-30-1
Loading And Unloading .....	10-30-1
Fastening .....	10-30-1
TOWING THE TELESCOPIC HANDLER .....	10-40-1
Procedure .....	10-40-1
SERVICE SCHEDULE .....	10-50-1
Chart .....	10-50-1
AIR CLEANER SERVICE .....	10-60-1
Replacing Filter Element(s) .....	10-60-1
ENGINE COOLING SYSTEM .....	10-70-1
Cleaning .....	10-70-1
Removing And Replacing The Coolant .....	10-70-1
Checking Level .....	10-70-3
FUEL SYSTEM .....	10-80-1
Fuel Specifications .....	10-80-1
Biodiesel Blend Fuel .....	10-80-1
Filling The Fuel Tank .....	10-80-2
Secondary Fuel Filter .....	10-80-2
Primary Fuel Filter (Pre-Filter) .....	10-80-3
Removing Air From The Fuel System .....	10-80-4
ENGINE LUBRICATION SYSTEM .....	10-90-1
Checking And Adding Engine Oil .....	10-90-1
Engine Oil Chart .....	10-90-1
Removing And Replacing Oil And Filter .....	10-90-2
HYDRAULIC / HYDROSTATIC SYSTEM .....	10-100-1
Checking And Adding Fluid .....	10-100-1
Hydraulic / Hydrostatic Fluid Chart .....	10-100-1
Removing And Replacing Hydraulic Fluid .....	10-100-2
Removing And Replacing Hydraulic / Hydrostatic Filter .....	10-100-3
Hydraulic Tank Breather .....	10-100-3
AXLES (FRONT AND REAR) .....	10-110-1
Checking And Adding Oil (Planetary Carrier) .....	10-110-1
Removing And Replacing Oil (Planetary Carrier) .....	10-110-1

Dealer Copy -- Not for Resale

Checking And Adding Oil (Rear Differential) .....	10-110-2
Removing And Replacing Oil (Rear Differential) .....	10-110-2
Checking And Adding Oil (Front Differential) .....	10-110-3
Removing And Replacing Oil (Front Differential) .....	10-110-4
Checking And Adding Oil (Front Drop Box) .....	10-110-5
Removing And Replacing Oil (Front Drop Box) .....	10-110-5
LUBRICATING THE TELESCOPIC HANDLER .....	10-120-1
Lubrication Locations .....	10-120-1
ATTACHMENT CARRIER .....	10-130-1
Inspection And Maintenance .....	10-130-1
TIRE MAINTENANCE .....	10-140-1
Wheel Nuts .....	10-140-1
Rotating .....	10-140-1
Mounting .....	10-140-1
ENGINE COVER .....	10-160-1
Opening And Closing .....	10-160-1
CHAIN .....	10-170-1
Checking And Adjustment Procedure .....	10-170-1
Extend / Retract Chain Wear Check .....	10-170-2
TELESCOPIC HANDLER STORAGE AND RETURN TO SERVICE .....	10-180-1
Storage .....	10-180-1
Return To Service .....	10-180-1
STOPPING THE ENGINE AND LEAVING THE TELESCOPIC HANDLER .....	10-190-1
Procedure .....	10-190-1
EMERGENCY EXIT .....	10-200-1
Rear Window .....	10-200-1

## LIFTING AND BLOCKING THE TELESCOPIC HANDLER

### Procedure

Always park the machine on a level surface.



The seat bar system must deactivate the lift, and tilt control functions when the seat bar is up. See your Bobcat dealer for service if joysticks do not deactivate.

W-2461-1210

Figure 10-10-1

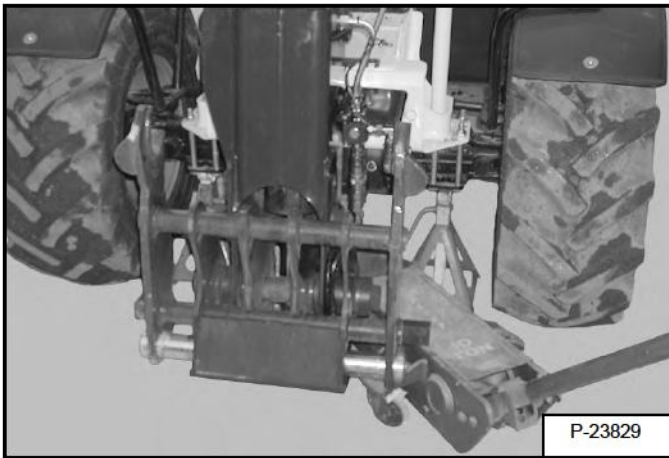

STOP the engine. Put the floor jack under the center of the front axle. Lift the telescopic handler and install jackstands [Figure 10-10-1].

Figure 10-10-2

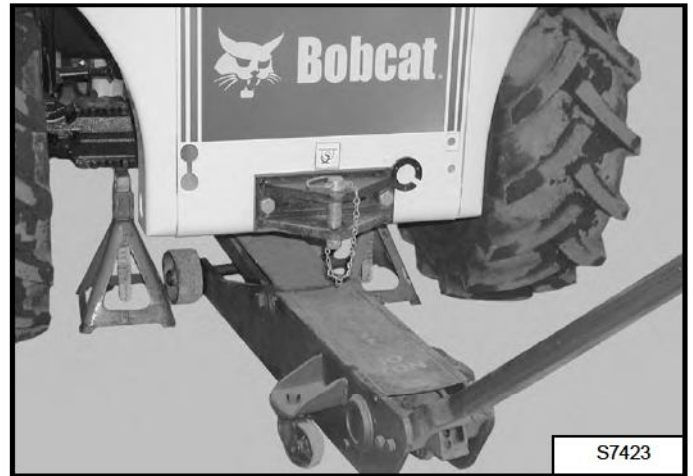

Put the floor jack under the center of the rear axle. Lift the telescopic handler and install jackstands [Figure 10-10-2].

## OPERATOR CAB (ROPS / FOPS)

Figure 10-20-1

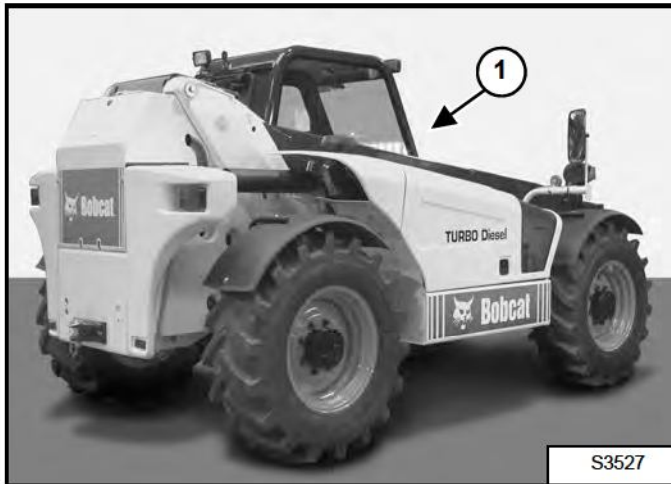

The telescopic handler has an operator cab (ROPS and FOPS) (Item 1) [Figure 10-20-1] to protect the operator from rollover and falling objects. Check with your dealer if the operator cab has been damaged. Never operate without right window. The seat belt must be worn for roll over protection.

ROPS / FOPS - Roll Over Protective Structure per SAE J1040 and ISO 3471, and Falling Object Protective Structure per SAE J1043 and ISO 3449 (FOPS Level II).

### **WARNING**

Never modify operator cab by welding, grinding, drilling holes or adding attachments unless instructed to do so by Bobcat Company. Do not operate without right window. Changes to the cab can cause loss of operator protection from rollover and falling objects, and result in serious injury or death.

W-2906-0211

## OPERATOR CAB (ROPS / FOPS) (CONT'D)

### Cab Door

Figure 10-20-2

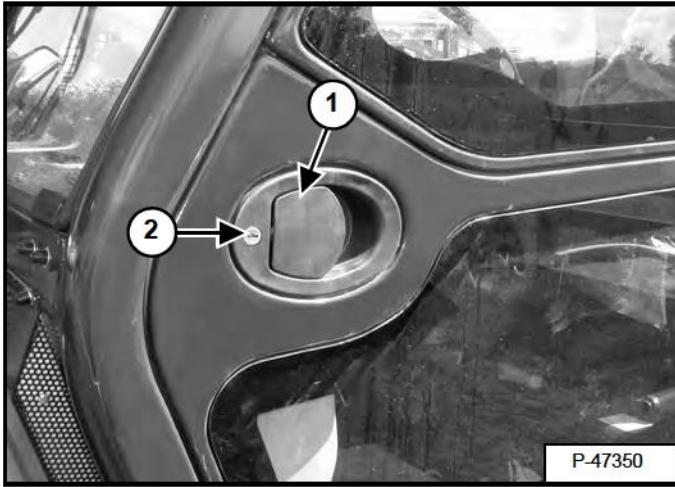
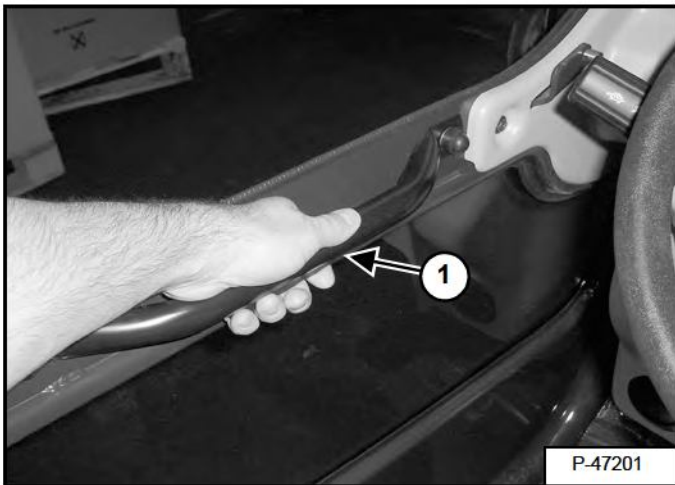

Figure 10-20-3



The cab door can be opened from the outside of the cab using the latch (Item 1) [Figure 10-20-2] and open from the inside of the cab when you squeeze the latch (Item 1) [Figure 10-20-3].

The cab door can be locked (Item 2) [Figure 10-20-2] with the start key.

### Cab Door Window

Figure 10-20-4

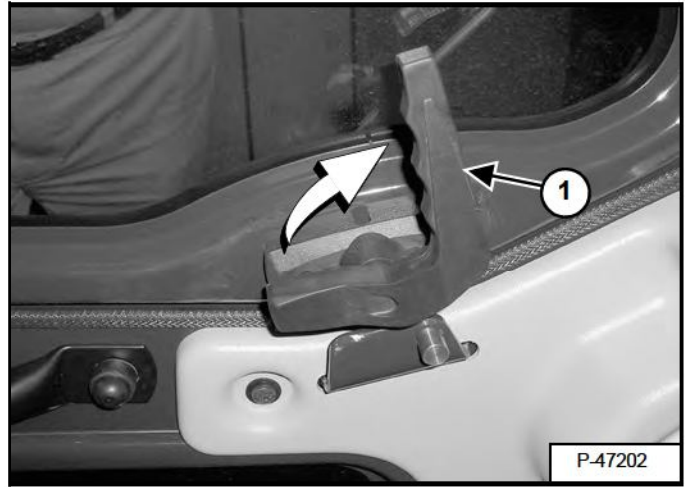

Turn the handle (Item 1) [Figure 10-20-4]. Push open the window fully until it latches against the cab.

Figure 10-20-5

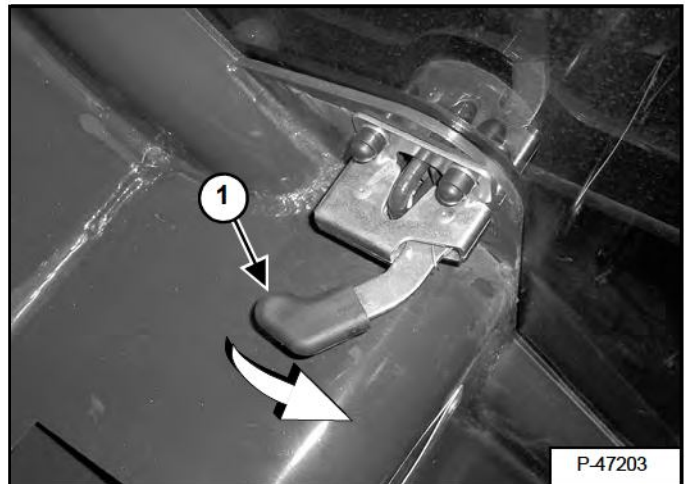

Pull the lever (Item 1) [Figure 10-20-5] inside the cab to disengage the latch and close the window.

## TRANSPORTING THE TELESCOPIC HANDLER ON A TRAILER

### Loading And Unloading

Figure 10-30-1

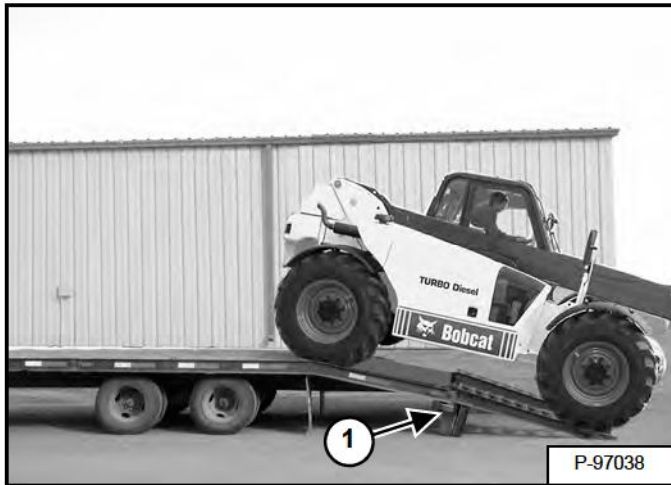

The telescopic handler must be loaded backward on the trailer.

The rear of the trailer must be blocked or supported (Item 1) [Figure 10-30-1] when loading or unloading the telescopic handler to prevent the front end of the trailer from raising up.

Be sure the transport and towing vehicles are of adequate size and capacity. For the weight of the telescopic handler (See Performance Specifications on Page SPEC-10-2.)

## WARNING

### AVOID SERIOUS INJURY OR DEATH

Adequately designed ramps of sufficient strength are needed to support the weight of the machine when loading onto a transport vehicle. Wood ramps can break and cause personal injury.

W-2058-0807

### Fastening

Figure 10-30-2

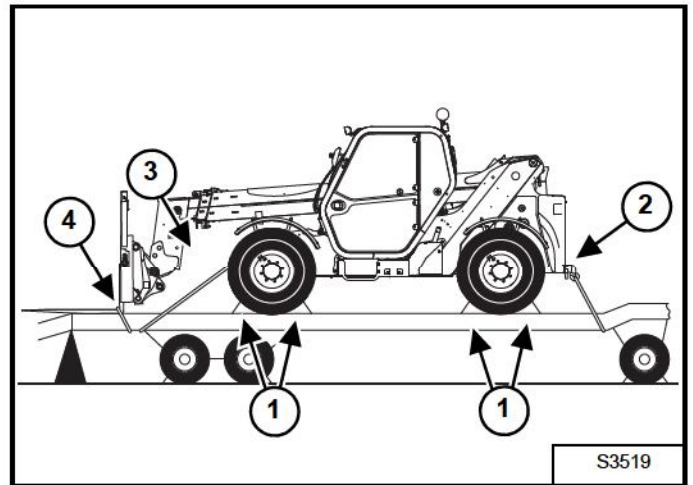

Fasten the telescopic handler to the transport vehicle to prevent it from moving during sudden stops or when going up or down slopes.

- Block the wheels (Item 1) [Figure 10-30-2].
- Fasten the machine frame to the transport vehicle (Items 2 and 3) [Figure 10-30-2].
- Attach the forks or bucket attachment to the transport vehicle (Item 4) [Figure 10-30-2].

## TOWING THE TELESCOPIC HANDLER

### Procedure

The telescopic handler can be towed a short distance such as removing it from mud or loading onto a transport vehicle.



### UNEXPECTED MACHINE MOVEMENT CAN CAUSE SERIOUS INJURY OR DEATH

- Block wheels to prevent roll away before adjusting screws to bypass the park brake system.
- Return adjustment screws to the operating position before operating the machine.

W-2808-0909

Block the wheels to prevent the machine from rolling.

### Releasing The Parking Brake Discs

The brakes are engaged by spring pressure and released by hydraulic pressure. The park brake must be released manually before towing. Only the front axle has brakes.

The following procedure describes how to release the brakes:

Figure 10-40-1

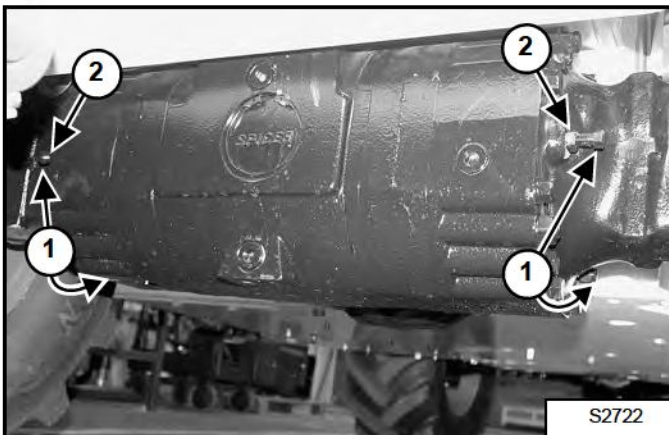
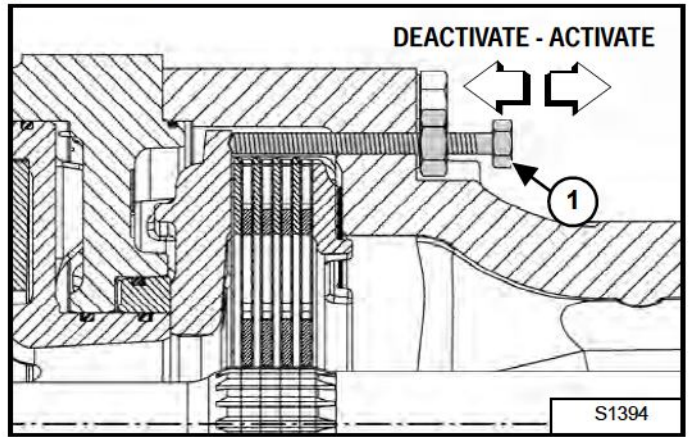

Figure 10-40-2



At each end of the central part of the front axle are two bolts (see (Item 1) [Figure 10-40-1] and (Item 1) [Figure 10-40-2]). When screwed in, these bolts will remove the spring pressure that engages the brake discs.

[Figure 10-40-2] shows the function of such a bolt inside the axle.

The work will first be carried out on the two bolts on one side of the front axle then the two bolts on the other side:

Loosen the locking nuts (Item 2) [Figure 10-40-1] of the bolts and create some clearance for the bolts.

Turn the two bolts (Item 1) [Figure 10-40-1] IN, 90° at a time, alternating between the two bolts until the bolts are firmly seated.

Repeat this on the two opposite side bolts on the front axle.

The brakes are now released for towing the machine.

Please note that the machine will not be able to brake until the bolts are returned to their original position.

Dealer Copy - Not for Resale

## TOWING THE TELESCOPIC HANDLER (CONT'D)

### Procedure (Cont'd)

#### Releasing The Parking Brake Discs (Cont'd)

Figure 10-40-3

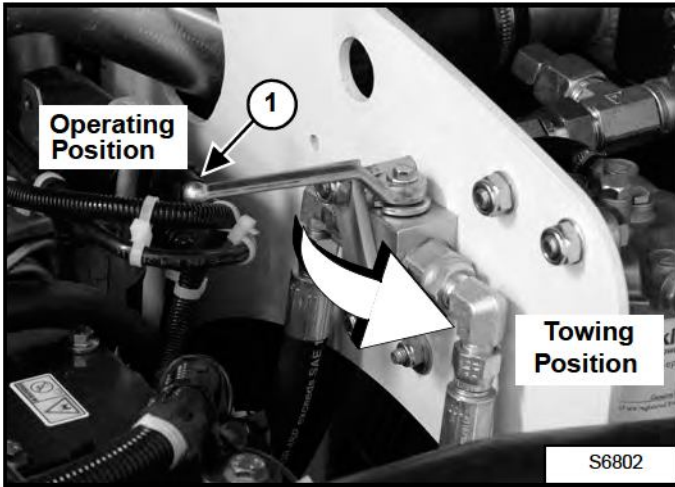

Raise the engine cover.

Turn the tow valve (Item 1) [Figure 10-40-3] counterclockwise 90° to TOWING POSITION.

Tow the telescopic handler at a slow speed.

## Engaging Brake Discs

# ! WARNING

**UNEXPECTED MACHINE MOVEMENT CAN CAUSE SERIOUS INJURY OR DEATH**

- Block wheels to prevent roll away before adjusting screws to bypass the park brake system.
- Return adjustment screws to the operating position before operating the machine.

W-2808-0909

Block the wheels to prevent the machine from rolling.

After towing is completed, turn the tow valve (Item 1) [Figure 10-40-3] clockwise 90° to the OPERATING POSITION.

Figure 10-40-4

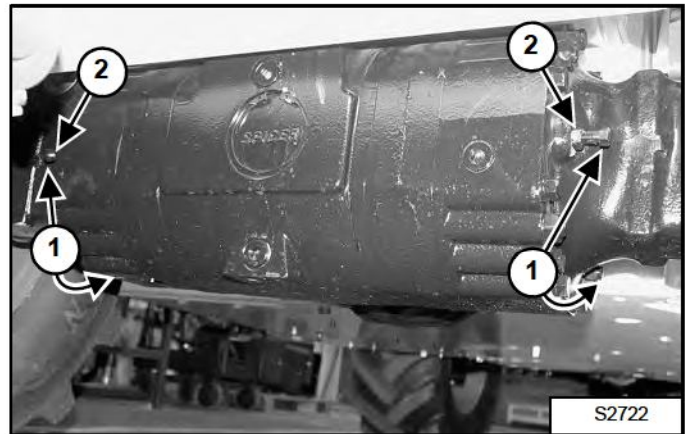

To reactivate the park brake, release the 4 bolts (see (Item 1) [Figure 10-40-4] on the front axle to their original position (turn the two bolts out, 90° turn at a time, until no resistance can be felt. Repeat this procedure for the opposite side two bolts).

Make sure that all 4 bolts have been turned out until they can easily be loosened by hand. Tighten the locking nuts (Item 2) [Figure 10-40-4].

This will allow the park brake piston to be active again.

## SERVICE SCHEDULE

### Chart

Maintenance work must be done at regular intervals. Failure to do so will result in excessive wear and early failures. The service schedule is a guide for correct maintenance of the Bobcat telescopic handler.

 <b>WARNING</b>	<p>Instructions are necessary before operating or servicing machine. Read and understand the Operation &amp; Maintenance Manual and signs (decals) on machine. Follow warnings and instructions in the manuals when making repairs, adjustments or servicing. Check for correct function after adjustments, repairs or service. Untrained operators and failure to follow instructions can cause injury or death.</p> <p style="text-align: right;">W-2003-EN-0903</p>
--	--

SERVICE SCHEDULE		HOURS					
ITEM	SERVICE REQUIRED	10	50	100	250	500	[5] 1000
Engine Oil	Check the oil level and add oil as needed.						
Hydraulic Fluid	Check fluid level and add as needed.						
Articulation Pins	Lubricate with lithium based multipurpose grease.						
Safety Signs, Safety Tread and Mirrors	Check for damaged signs (decals), safety tread and mirrors. Replace if damaged or worn.						
Fuel Filter	Clean the sediment bowl / water trap.						
Nuts and Bolts	Check for loose nuts and bolts. Tighten as needed.						
Seat Belt	Check the condition of the seat belt.						
Brakes	Check for function. Service as necessary.						
Back-up Alarm (if equipped)	Check for function. Replace as necessary.						
Tires	Check for wear or damage. Inflate to correct pressure. Be sure all tires are inflated to the same pressure. Use only approved tires.						
Engine Air Filter And Air System	Check condition indicator, replace element when required and empty dust cup as needed. Check air system for leaks.						
Engine Cooling System	Clean debris from oil cooler, radiator and air conditioner condenser. check coolant level cold in reservoir. Add premixed coolant as needed. (See ENGINE COOLING SYSTEM.) Check cooling system for leaks.						
King Pins, Axle Oscillation (Front/Rear), Attach. Frame Pivot(s), Tilt / Lift Cyl., Boom Pivot, Leveling Cyl.	Lubricate with lithium based multipurpose grease.						
Telescopic Boom Slide	Lubricate with lithium based multipurpose grease. Check wear blocks for adjustment or replacement.						
Hydraulic Hoses, Tubelines and Connections	Check condition of hoses, tubelines and connectors. Repair or replace as needed.						
Battery	Check electrolyte level. Add distilled water as needed.						
Wheel Nuts	Check wheel nut torque. Tighten as needed (300 N•m [221 ft-lb]).	[1]					
Boom Chain	Check and apply chain lubricant as needed. Check chain tension and wear. Adjust or replace as necessary.						
Alt. and Air Cond. Belt (if equipped)	Check belt tension and adjust as needed.		[2]				
Door hinges	Lubricate door hinges with lithium based multipurpose grease.						
Engine Oil and Filter	Replace the engine oil and filter. See SPECIFICATIONS for correct capacity. Use a genuine Bobcat filter.		[2]				
Engine Air Filter	Replace the outer filter element. Use a genuine Bobcat filter.		[2]				
Fuel Filter, secondary	Replace the secondary fuel filter element. Use a genuine Bobcat filter.		[2]				
Fuel Filter, primary	Replace the primary fuel filter (pre-filter) element. Use a genuine Bobcat filter.		[2]				
Hydraulic Fluid Filter	Replace the hydraulic filter element. Use a genuine Bobcat filter.		[2]				
Hydraulic Tank Breather	Replace the hydraulic tank breather.						
Hydraulic Fluid and Filter	Replace the hydraulic fluid and filter element. See SPECIFICATIONS.						
Front and Rear Axle Fluid	Replace the axle fluid. See SPECIFICATIONS.			[3]		[4]	
Telescopic Boom Wear Blocks	Check for wear and adjust as needed. Replace as necessary.						
Pivot Pins and Bushings	Check for wear on the pivot pins and bushings.						
Engine valve lash	Check and adjust as needed.						
Stabilizers (If Equipped): Cylinders and pivots	Lubricate with lithium based multipurpose grease.						
Engine Coolant	Check freeze protection of antifreeze -30°C (-34°F). Flush cooling system and replace with premixed coolant						Every 2 years

[1]Check wheel nut torque every 8 hours for the first 24 hours.

[2]Perform service first time, then as indicated in chart.

[3]Check level.

[4]Replace fluid first time, then as indicated in chart.

[5]Or every 12 months.

Dealer Copy -- Not for Resale

## AIR CLEANER SERVICE

### Replacing Filter Element(s)

Figure 10-60-1

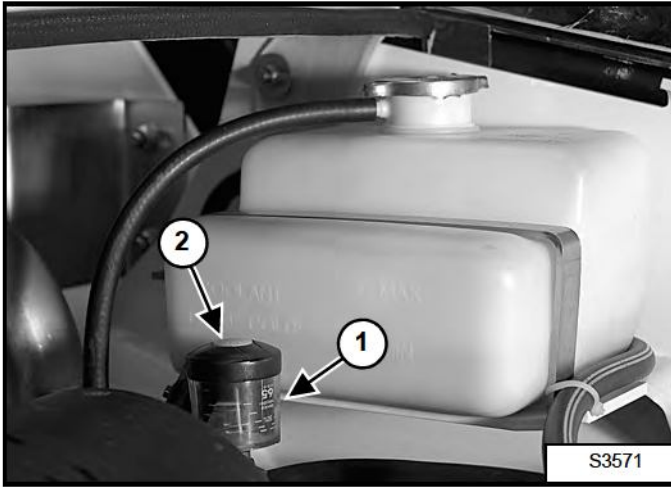

Replace the large (outer) filter element only when the red ring shows in the window of the condition indicator (Item 1) [Figure 10-60-1].

**NOTE:** Before replacing the filter element, push the button on the condition indicator (Item 2) [Figure 10-60-1]. Start the engine. If the red ring does not show, do not replace the filter element.

Replace the inner filter every third time the outer filter is replaced or when the red ring still shows in the indicator window after the outer filter has been replaced.

### Outer Filter

Figure 10-60-2

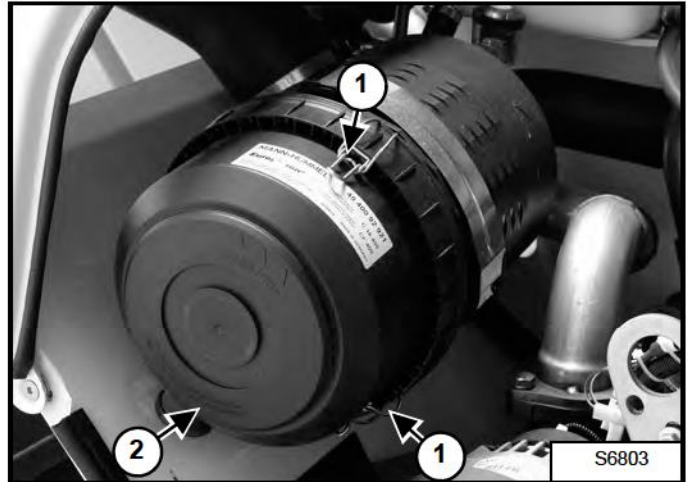

Loosen the filter housing clamps (Item 1) [Figure 10-60-2].

Release the fastener and remove the cover (Item 2) [Figure 10-60-2].

Figure 10-60-3

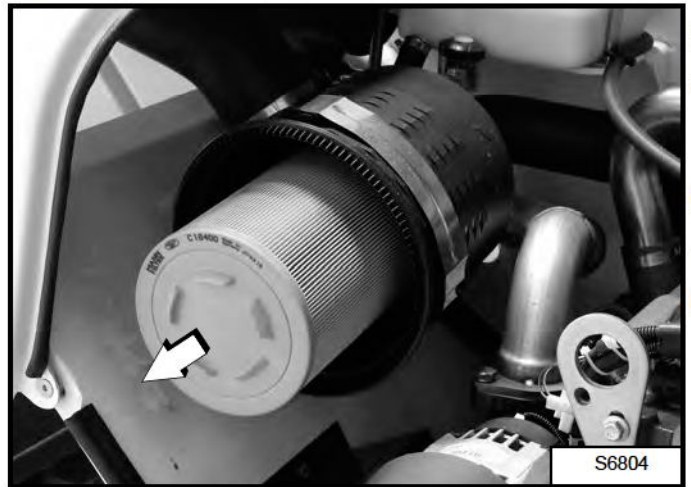

Pull the element straight out [Figure 10-60-3].

**NOTE:** Make sure all sealing surfaces are free of dirt and debris.

Install a new outer element.

Install the dust cover and fasten [Figure 10-60-2].

Connect the filter housing clamps.

Dealer Copy -- Not for Resale

## AIR CLEANER SERVICE (CONT'D)

### Replacing Filter Element (Cont'd)

#### *Inner Filter*

Remove the outer element.

**NOTE:** Make sure all sealing surfaces are free of dirt and debris.

Figure 10-60-4

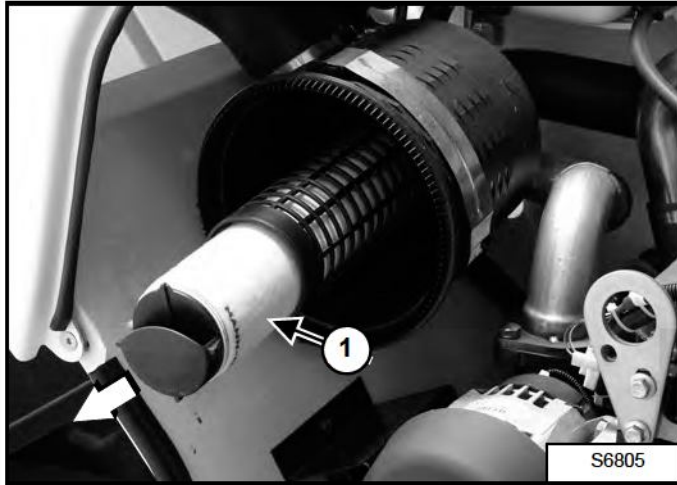

Remove the inner filter (Item 1) [Figure 10-60-4] and install a new element.

Install the outer element.

Install the dust cover and fasten [Figure 10-60-2].

Connect the filter housing clamp (Item 1) [Figure 10-60-2].

## ENGINE COOLING SYSTEM

Check the cooling system every day to prevent overheating, loss of performance or engine damage.

### **WARNING**

#### **AVOID INJURY OR DEATH**

Wear safety glasses to prevent eye injury when any of the following conditions exist:

- When fluids are under pressure.
- Flying debris or loose material is present.
- Engine is running.
- Tools are being used.

W-2019-0907

## Cleaning

Figure 10-70-1



Open the engine cover (Item 1) [Figure 10-70-1].

Figure 10-70-2

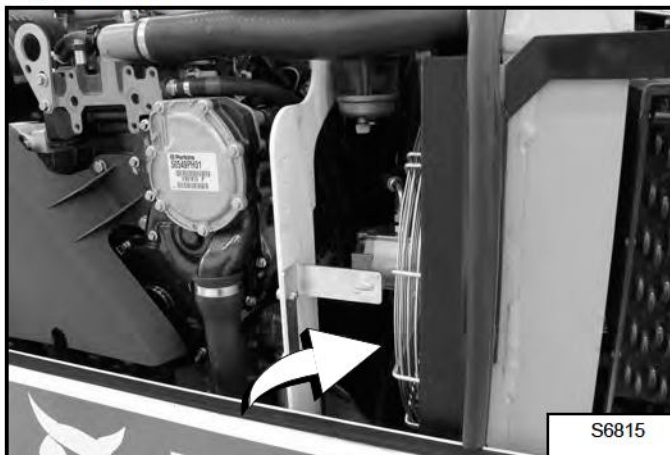

Use low air pressure or water pressure to clean the radiator, oil cooler and intercooler [Figure 10-70-2].

## Removing And Replacing The Coolant

### **WARNING**

#### **AVOID BURNS**

Do not remove radiator cap when the engine is hot. You can be seriously burned.

W-2070-1203

Open the engine cover.

Figure 10-70-3

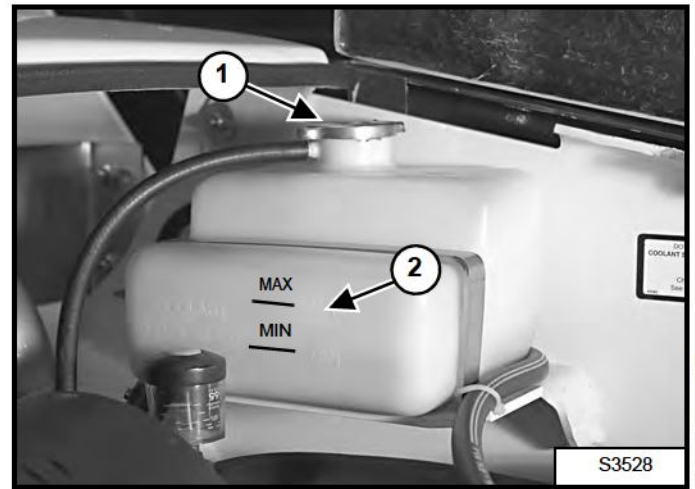

Remove the cap (Item 1) [Figure 10-70-3] from the coolant reservoir.

Remove the fan shield.

Dealer Copy -- Not for Resale

## ENGINE COOLING SYSTEM (CONT'D)

### Removing And Replacing The Coolant (Cont'd)

Figure 10-70-4

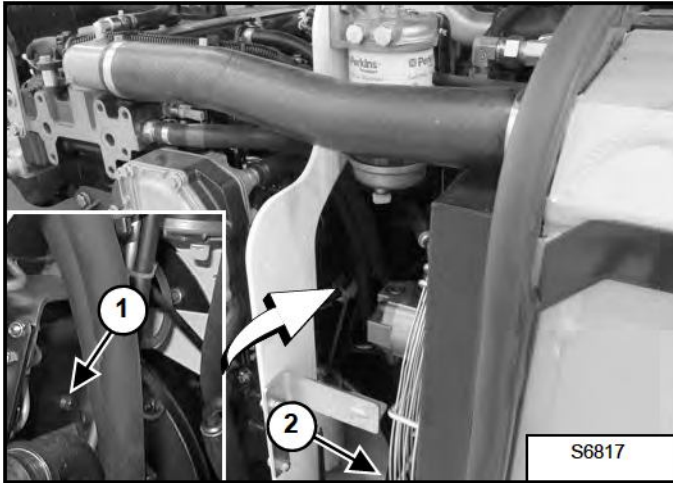

Remove the engine block drain plug (Item 1) [Figure 10-70-4].

Open the drain valve (Item 2) [Figure 10-70-4] and drain all of the coolant into a container. Dispose of used coolant in an environmentally safe manner.

Close the drain valves.

**NOTE:** The cooling system is factory filled with ethylene glycol (EG) coolant. **DO NOT** mix ethylene glycol with propylene glycol.

Add premixed coolant to the reservoir if the coolant level is low.

Use a refractometer to check the condition of ethylene glycol in your cooling system.

Fill the radiator with the premixed coolant. Install the radiator cap.

Add coolant to the reservoir. The coolant level must be between the MIN and MAX marks (Item 2) [Figure 10-70-3] on the coolant reservoir.

Follow the following steps when using concentrated coolant instead of a ready-to-use premix:

- mix the coolant in a separate container: 4,3 L (one gallon and one pint) of ethylene glycol mixed with 3,8 L (one gallon) of water is the correct mixture of coolant to provide a -37°C (-34°F) freeze protection.
- Add premixed coolant, 47% water and 53% ethylene glycol to the coolant tank until the coolant level reaches the MIN marker on the tank (Item 1) [Figure 10-70-3].

Run the engine until it is at operating temperature.

Stop the engine.

Check the coolant level (COLD) in the reservoir when cool.

Add coolant to the reservoir as needed.

## IMPORTANT

### AVOID ENGINE DAMAGE

Always use the correct ratio of water to antifreeze.

Too much antifreeze reduces cooling system efficiency and may cause serious premature engine damage.

Too little antifreeze reduces the additives which protect the internal engine components; reduces the boiling point and freeze protection of the system.

Always add a premixed solution. Adding full strength concentrated coolant can cause serious premature engine damage.

I-2124-0497

## ENGINE COOLING SYSTEM (CONT'D)

### Checking Level

Open the engine cover.

Check the coolant level in the coolant reservoir.

Figure 10-70-5

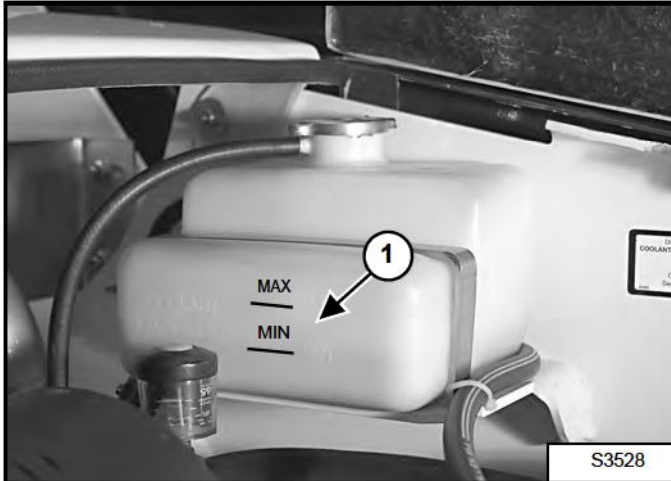

The coolant level must be between the MIN and MAX marks (Item 1) [Figure 10-70-5] on the coolant reservoir when the engine is cold.

# IMPORTANT

### AVOID ENGINE DAMAGE

Always use the correct ratio of water to antifreeze.

Too much antifreeze reduces cooling system efficiency and may cause serious premature engine damage.

Too little antifreeze reduces the additives which protect the internal engine components; reduces the boiling point and freeze protection of the system.

Always add a premixed solution. Adding full strength concentrated coolant can cause serious premature engine damage.

I-2124-0497

## FUEL SYSTEM

### Fuel Specifications

Use only clean, high quality diesel fuel, Grade No. 2 or Grade No. 1.

The following is one suggested blending guideline which should prevent fuel gelling problems in cold temperatures:

TEMPERATURE	NO. 2	NO. 1
-9°C (+15°F)	100%	0%
Down to -29°C (-20°F)	50%	50%
Below -29°C (-20°F)	0%	100%

At a minimum, Low Sulfur (500 ppm sulfur) Diesel Fuel must be used in this machine:

The following fuels may also be used in this machine:

- Ultra Low Sulfur (15 ppm sulfur) Diesel Fuel.
- Biodiesel Blend Fuel - Must contain no more than five percent biodiesel mixed with low sulfur or ultra low sulfur petroleum based diesel. This is commonly marketed as B5 blended diesel fuel. B5 blended diesel fuel must meet ASTM D975 (US Standard) or EN590 (EU Standard) specifications.

### Biodiesel Blend Fuel

Biodiesel blend fuel has unique qualities that should be considered before using in this machine:

- Cold weather conditions can lead to plugged fuel system components and hard starting.
- Biodiesel blend fuel is an excellent medium for microbial growth and contamination which can cause corrosion and plugging of fuel system components.
- Use of biodiesel blend fuel may result in premature failure of fuel system components, such as plugged fuel filters and deteriorated fuel lines.
- Shorter maintenance intervals may be required, such as cleaning the fuel system and replacing fuel filters and fuel lines.
- Using biodiesel blended fuels containing more than five percent biodiesel can affect engine life and cause deterioration of hoses, tubelines, injectors, injector pump and seals.

Apply the following guidelines if biodiesel blend fuel is used:

- Ensure the fuel tank is as full as possible at all times to prevent moisture from collecting in the fuel tank.
- Ensure that the fuel tank cap is securely tightened.
- Biodiesel blend fuel can damage painted surfaces, remove all spilled fuel from painted surfaces immediately.
- Drain all water from the fuel filter daily before operating the machine.
- Do not exceed engine oil change interval. Extended oil change intervals can cause engine damage.
- Before machine storage; drain the fuel tank, refill with 100% petroleum diesel fuel, add fuel stabilizer and run the engine for at least 30 minutes.

**NOTE: Biodiesel blend fuel does not have long term stability and should not be stored for more than 3 months.**

Dealer Copy -- Not for Resale



**Suggest:**

**If the above button click is invalid.**

**Please download this document**

**first, and then click the above link**

**to download the complete manual.**

**Thank you so much for reading**

## FUEL SYSTEM (CONT'D)

### Filling The Fuel Tank

# ! WARNING

### AVOID INJURY OR DEATH

Stop and cool the engine before adding fuel. **NO SMOKING!** Failure to obey warnings can cause an explosion or fire.

W-2063-0807

Figure 10-80-1

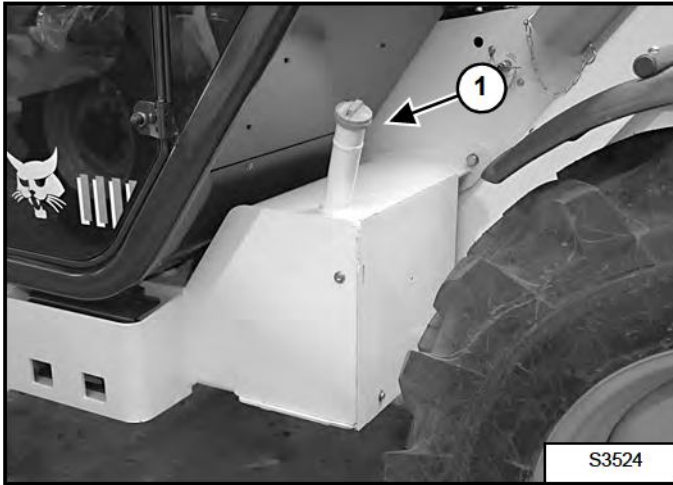

Remove the fuel fill cap (Item 1) [Figure 10-80-1].

Use a clean, approved safety container to add fuel of the correct specifications. Add fuel only in an area that has free movement of air and no open flames or sparks. **NO SMOKING!**

Install and tighten the fuel fill cap [Figure 10-80-1].

### Secondary Fuel Filter

See the SERVICE SCHEDULE for the service interval when to replace the secondary fuel filter. (See SERVICE SCHEDULE on Page 10-50-1.)

Figure 10-80-2

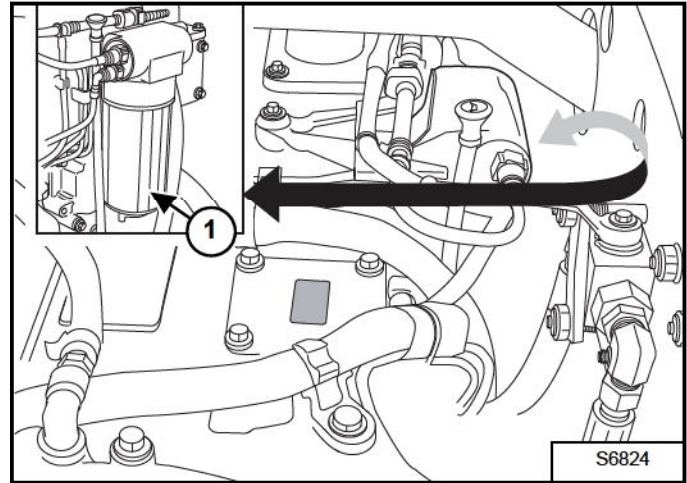

Remove the filter element (Item 1) [Figure 10-80-2].

Clean the area around the filter housing.

Install the new filter element with a new seal, and hand tighten.

Remove air from the fuel system. (See Removing Air From The Fuel System on Page 10-80-4.)

# ! WARNING

### AVOID INJURY OR DEATH

Always clean up spilled fuel or oil. Keep heat, flames, sparks or lighted tobacco away from fuel and oil. Failure to use care around combustibles can cause explosion or fire.

W-2103-0508

**<https://www.ebooklibonline.com>**

Hello dear friend!

Thank you very much for reading.

Enter the link into your browser.

The full manual is available for immediate download.

**<https://www.ebooklibonline.com>**