

T3571

S/N 362811001
& above

T3571L

S/N 362911001
& above



Bobcat®

SERVICE MANUAL

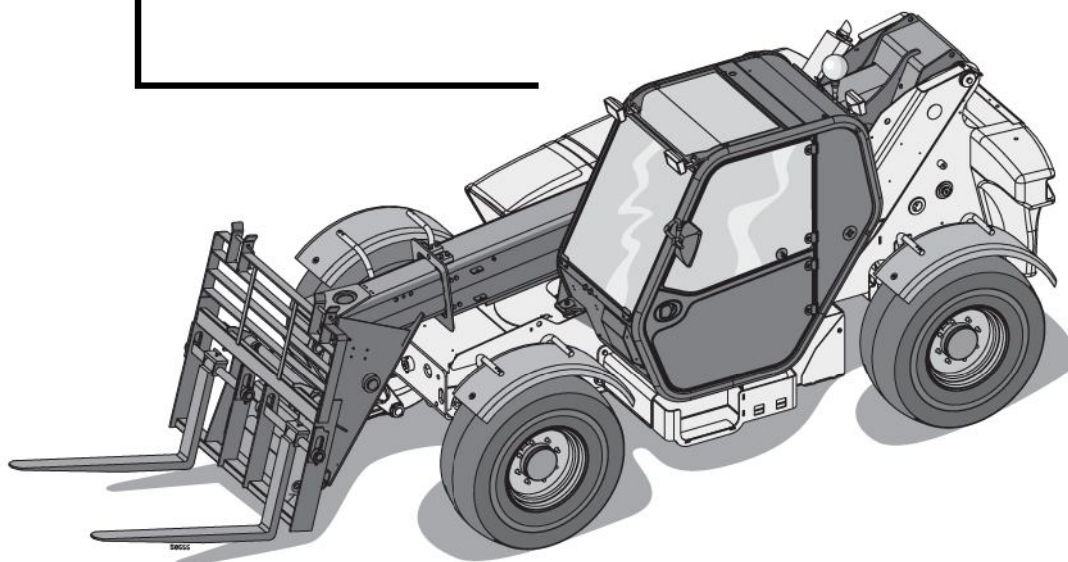

Doosan purchased Bobcat Company from Ingersoll-Rand Company in 2007. Any reference to Ingersoll-Rand Company or use of trademarks, service marks, logos, or other proprietary identifying marks belonging to Ingersoll-Rand Company in this manual is historical or nominative in nature, and is not meant to suggest a current affiliation between Ingersoll-Rand Company and Bobcat Company or the products of either.

MAINTENANCE SAFETY



WARNING

Instructions are necessary before operating or servicing machine. Read and understand the Operation & Maintenance Manual, Operator's Handbook and signs (decals) on machine. Follow warnings and instructions in the manuals when making repairs, adjustments or servicing. Check for correct function after adjustments, repairs or service. Untrained operators and failure to follow instructions can cause injury or death.

W-2003-0903

CORRECT



B-10731a

- ⚠ Never service the Bobcat Telescopic Handler without instructions.



Safety Alert Symbol: This symbol with a warning statement, means: "Warning, be alert! Your safety is involved!" Carefully read the message that follows.

CORRECT

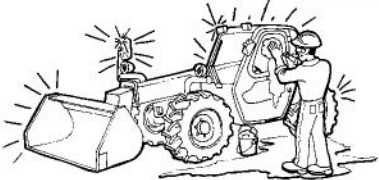

B-16082

- ⚠ Cleaning and maintenance are required daily.

WRONG

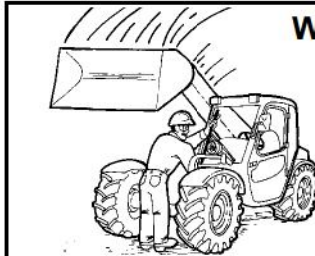

B-16080

- ⚠ Disconnecting or loosening any hydraulic tubeline, hose, fitting, component or a part failure can cause boom to drop. Do not go under boom when raised unless supported by an approved boom stop. Replace if damaged.

WRONG

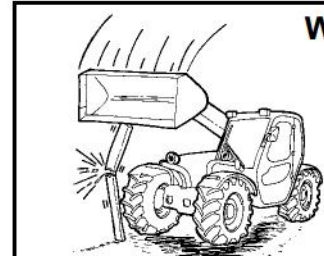

B-16079

- ⚠ Never work on Telescopic Handler with boom up unless boom is held by an approved boom stop. Replace if damaged.
- ⚠ Never modify equipment or add attachments not approved by Bobcat Company.

WRONG



B-16081

- ⚠ Have good ventilation when welding or grinding painted parts.
- ⚠ Wear dust mask when grinding painted parts. Toxic dust and gas can be produced.
- ⚠ Avoid exhaust fume leaks which can kill without warning. Exhaust system must be tightly sealed.

WRONG

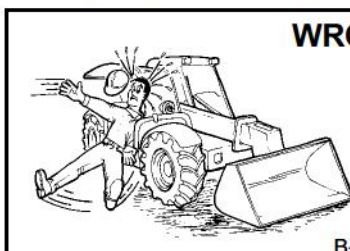

B-16078

- ⚠ Keep body, jewelry and clothing away from moving parts, electrical contact, hot parts and exhaust.
- ⚠ Wear eye protection to guard from battery acid, compressed springs, fluids under pressure and flying debris when engines are running or tools are used. Use eye protection approved for type of welding.

WRONG



B-6589

- ⚠ Lead-acid batteries produce flammable and explosive gases.
- ⚠ Keep arcs, sparks, flames and lighted tobacco away from batteries.
- ⚠ Batteries contain acid which burns eyes or skin on contact. Wear protective clothing. If acid contacts body, flush well with water. For eye contact flush well and get immediate medical attention.

Maintenance procedures which are given in the Operation & Maintenance Manual can be performed by the owner/operator without any specific technical training. Maintenance procedures which are not in the Operation & Maintenance Manual must be performed **ONLY BY QUALIFIED BOBCAT SERVICE PERSONNEL**. Always use genuine Bobcat replacement parts.

MSW12-0805

ALPHABETICAL INDEX

<p>ACCUMULATOR..... 20-210</p> <p>AIR CLEANER 70-40</p> <p>AIR CLEANER SERVICE 10-60</p> <p>AIR CONDITIONING SERVICE 80-90</p> <p>AIR CONDITIONING SYSTEM FLOW 80-10</p> <p>ALTERNATOR..... 60-30</p> <p>OPTIONAL APPROVED BOOM STOP 10-150</p> <p>AXLE AND DIFFERENTIAL (FRONT) (For S/N 362811001 - 362812000, S/N 362911001 - 362912000) . 40-20</p> <p>AXLE AND DIFFERENTIAL (FRONT) (For S/N 362812001 and Above, S/N 362912001 and Above)40-22</p> <p>AXLE AND DIFFERENTIAL (REAR) (For S/N 362811001 - 362812000, S/N 362911001 - 362912000) (Cont'd) . 40-21</p> <p>AXLE AND DIFFERENTIAL (REAR) (For S/N 362812001 and Above, S/N 362912001 and Above)..... 40-23</p> <p>AXLE PIVOT FRAME (Only For S/N 362811001 - 362812000, S/N 362911001 - 362912000) 40-32</p> <p>AXLE TOE-IN (For S/N 362811001 - 362812000, S/N 362911001 - 362912000) 40-40</p> <p>AXLE TOE-IN (For S/N 362812001 and Above, S/N 362912001 and Above)..... 40-41</p> <p>AXLES (FRONT AND REAR) (For S/N 362811001 - 362812000, S/N 362911001 - 362912000) 10-110</p> <p>AXLES (FRONT AND REAR) (For S/N 362812001 and Above, S/N 362912001 and Above).....10-111</p> <p>BASIC TROUBLESHOOTING 80-50</p> <p>BATTERY 60-20</p> <p>BOOM ASSEMBLY 50-30</p> <p>BRAKE LIGHT SWITCH 60-100</p> <p>BRAKE VALVE 20-120</p> <p>BUCKET POSITIONING CYLINDER..... 20-30</p> <p>COMPONENTS 80-20</p> <p>COMPRESSOR 80-110</p> <p>CONDENSER 80-120</p> <p>CONVERSIONS..... SPEC-70</p> <p>DASH COVER/STEERING COLUMN COVER..... 50-130</p> <p>DRIVE BOX (For S/N 362811001 - 362812000, S/N 362911001 - 362912000) 20-70</p> <p>DRIVE BOX (For S/N 362812001 and Above, S/N 362912001 and Above)..... 20-71</p> <p>DRIVESHAFT 40-01</p> <p>ELECTRICAL SYSTEM INFORMATION 60-10</p> <p>ENGINE AND ENGINE MOUNTS 70-60</p> <p>ENGINE COMPONENTS AND TESTING 70-70</p> <p>ENGINE COOLING SYSTEM 10-70</p> <p>ENGINE COVER..... 10-160</p> <p>ENGINE COVER..... 50-70</p> <p>ENGINE/HYDROSTAT ASSEMBLY 70-80</p> <p>ENGINE LUBRICATION SYSTEM..... 10-90</p> <p>ENGINE SPECIFICATIONS..... SPEC-20</p> <p>ENGINE SPEED CONTROL..... 70-20</p> <p>ENGINE TIMING..... 70-71</p>	<p>EVAPORATOR/BLOWER UNIT 80-150</p> <p>EXPANSION VALVE 80-160</p> <p>EXTENSION CYLINDER 20-40</p> <p>FAN MOTOR..... 20-140</p> <p>FENDER 50-120</p> <p>FLOW CONTROL VALVE 20-172</p> <p>FLYWHEEL AND HOUSING 70-90</p> <p>FRAME LEVELING CYLINDER..... 20-100</p> <p>FRONT AXLE WITHOUT FRAME LEVELING (For S/N 362811001 - 362812000) 40-30</p> <p>FRONT AXLE WITH FRAME LEVELING (For S/N 362911001 - 362912000) 40-31</p> <p>FRONT AXLE (For S/N 362812001 and Above, S/N 362912001 and Above)..... 40-33</p> <p>FRONT WIPER MOTOR..... 60-110</p> <p>FUEL SYSTEM 10-80</p> <p>FUEL TANK..... 50-80</p> <p>GEAR PUMP..... 20-130</p> <p>GENERAL AIR CONDITIONING SERVICE GUIDELINES 80-60</p> <p>HEATER ASSEMBLY 80-170</p> <p>HYDRAULIC CONNECTION SPECIFICATIONSSPEC-50</p> <p>HYDRAULIC CONTROL VALVE..... 20-170</p> <p>HYDRAULIC/HYDROSTATIC FLUID SPECIFICATIONS SPEC-60</p> <p>HYDRAULIC/HYDROSTATIC SYSTEM 10-100</p> <p>HYDRAULIC RESERVOIR 20-150</p> <p>HYDRAULIC SYSTEM INFORMATION..... 20-10</p> <p>HYDROSTATIC DRIVE MOTOR..... 30-30</p> <p>HYDROSTATIC PUMP..... 30-40</p> <p>HYDROSTATIC SYSTEM INFORMATION 30-10</p>
---	--

Dealer Copy -- Not for Resale

ALPHABETICAL INDEX (CONT'D)

<p>INCHING SWITCH60-150</p> <p>INNER BOOM.....50-40</p> <p>INSTRUMENT PANEL.....60-80</p> <p>JOYSTICK20-180</p> <p>JOYSTICK PANEL.....50-140</p> <p>LIFT CYLINDER20-20</p> <p>LIFTING AND BLOCKING THE Telescopic Handler ...10-10</p> <p>LIGHTS.....60-60</p> <p>LUBRICATION (For S/N 362812001 and Above, S/N 362912001 and Above) 10-121</p> <p>LUBRICATION (For S/N 362811001 - 362812000, S/N 362911001 - 362912000).....10-120</p> <p>LONGITUDINAL STABILITY INDICATOR CALIBRATION.....60-180</p> <p>MACHINE TORQUE SPECIFICATIONSSPEC-30</p> <p>MAIN RELIEF VALVE20-80</p> <p>MUFFLER.....70-30</p> <p>OIL COOLER.....30-20</p> <p>OIL COOLER/RADIATOR.....70-50</p> <p>OPERATOR CAB.....10-20</p> <p>OPERATOR CAB.....50-10</p> <p>OPERATOR SEAT50-20</p> <p>PARKING BRAKE.....20-190</p> <p>PARKING BRAKE (For S/N 362811001 - 362812000, S/N 362911001 - 362912000)40-50</p> <p>PARKING BRAKE (For S/N 362812001 and Above, S/N 362912001 and Above)40-51</p> <p>PEDAL ASSEMBLY60-140</p> <p>PIVOT LINK.....50-120</p> <p>PORT RELIEF VALVES.....20-171</p> <p>PILOT PRESSURE LOCK OUT VALVE20-200</p> <p>PRESSURE SWITCH.....80-140</p> <p>QUICK TACH50-90</p> <p>QUICK TACH CYLINDER.....20-90</p> <p>REAR AXLE (For S/N 362811001 - 362812000, S/N 362911001 - 362912000).....40-90</p> <p>REAR AXLE (For S/N 362812001 and Above, S/N 362912001 and Above)..... 40-91</p> <p>REAR WEIGHTS50-100</p> <p>REAR WIPER MOTOR.....60-130</p> <p>RECEIVER/DRIER80-130</p> <p>RECONDITIONING THE ENGINE70-100</p> <p>REGULAR MAINTENANCE80-40</p>	<p>SAFETY 80-30</p> <p>SERVICE BRAKE (For S/N 362811001 - 362812000, S/N 362911001 - 362912000)..... 40-80</p> <p>SERVICE BRAKE (For S/N 362812001 and Above, S/N 362912001 and Above)40-81</p> <p>SERVICE SCHEDULE 10-50</p> <p>STARTER.....60-40</p> <p>STEERING ANGLE ADJUSTMENT (For S/N 362811001 - 362812000, S/N 362911001 - 362912000) 40-60</p> <p>STEERING ANGLE ADJUSTMENT (For S/N 362812001 and Above, S/N 362912001 and Above)..... 40-61</p> <p>STEERING CYLINDER (FRONT) (For S/N 362811001 - 362812000, S/N 362911001 - 362912000) 20-60</p> <p>STEERING CYLINDER (FRONT) (For S/N 362812001 and Above, S/N 362912001 and Above)..... 20-61</p> <p>STEERING CYLINDER (REAR) (For S/N 362811001 - 362812000, S/N 362911001 - 362912000) 20-62</p> <p>STEERING CYLINDER (REAR) (For S/N 362812001 and Above, S/N 362912001 and Above)..... 20-63</p> <p>STEERING MODE VALVE BLOCK 20-110</p> <p>STEERING VALVE 20-160</p> <p>SWITCH PANEL.....60-90</p> <p>SYSTEM CHARGING AND RECLAMATION..... 80-100</p> <p>SYSTEM TROUBLESHOOTING CHART 80-70</p> <p>TEMPERATURE/PRESSURE..... 80-80</p> <p>TIRE MAINTENANCE 10-130</p> <p>TILT CYLINDER 20-50</p> <p>TOP WIPER MOTOR 60-120</p> <p>TORQUE SPECIFICATIONS FOR BOLTS SPEC-40</p> <p>Optional TOW VALVE..... 20-220</p> <p>TOWING THE Telescopic Handler 10-40</p> <p>TRANSPORTING THE Telescopic Handler 10-30</p> <p>TRAVEL/SIGNAL LEVER.....60-70</p> <p>AXLES TROUBLESHOOTING.....40-10</p> <p>ENGINE TROUBLESHOOTING 70-10</p> <p>Telescopic Handler SPECIFICATIONS SPEC-10</p> <p>WEAR PADS (FRONT) 50-50</p> <p>WEAR PADS (REAR)..... 50-60</p>
--	---

<https://www.ebooklibonline.com>

Hello dear friend!

Thank you very much for reading.

Enter the link into your browser.

The full manual is available for immediate download.

<https://www.ebooklibonline.com>

CONTENTS

FOREWORDII
SAFETY INSTRUCTIONSV
SERIAL NUMBER LOCATIONS.....	..VII
DELIVERY REPORTVII
IDENTIFICATION OF THE TELESCOPIC HANDLER.....	..VIII
SAFETY AND MAINTENANCE	10-01
HYDRAULIC SYSTEM.....	20-01
HYDROSTATIC SYSTEM.....	30-01
DRIVE SYSTEM.....	40-01
MAIN FRAME.....	50-01
ELECTRICAL SYSTEM AND ANALYSIS.....	60-01
ENGINE SERVICE.....	70-01
HEATING, VENTILATION, AIR CONDITIONING	80-01
SPECIFICATIONS	SPEC-01

**SAFETY &
MAINTENANCE**

**HYDRAULIC
SYSTEM**

**HYDROSTATIC
SYSTEM**

**DRIVE
SYSTEM**

MAIN FRAME

**ELECTRICAL
SYSTEM &
ANALYSIS**

**ENGINE
SERVICE**

HVAC

SPECIFICATIO

FOREWORD

This manual is for the Bobcat Telescopic Handler mechanic. It provides necessary servicing and adjustment procedures for the Bobcat Telescopic Handler and its component parts and systems. Refer to the Operation & Maintenance Manual for operating instructions, starting procedure, daily checks, etc.

A general inspection of the following items must be made after the Telescopic Handler has had service or repair:

1. Check that ROPS/FOPS (including right side window) is in good condition and is not modified.



2. Check that ROPS mounting hardware is tightened and is Bobcat approved.



3. The seat belt must be correctly installed, functional and in good condition.



4. Check boom support device, replace if damaged.

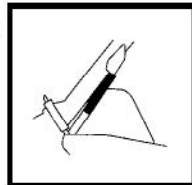

5. Machine signs must be legible and in the correct location.



6. Check tires for wear and pressure. Use only approved tires.



7. Check for correct function of the work lights.



8. The parking brake must function correctly.

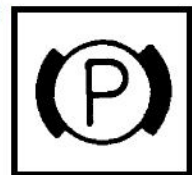

9. Enclosure door latches must open and close freely.

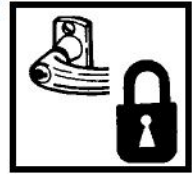

10. Attachment locking pins must function correctly and be in good condition.



11. Safety treads must be in good condition.



12. Check for correct function of indicator lamps and gauges.

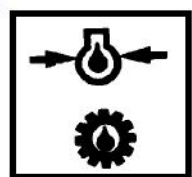

13. Check hydraulic fluid level, engine oil level and fuel supply.



14. Inspect for fuel, oil or hydraulic fluid leaks.

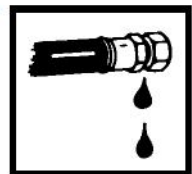

15. Lubricate the Telescopic Handler.



16. Check the condition of the battery and cables.

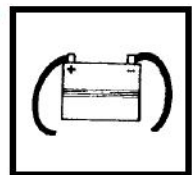

17. Inspect the air cleaner for damage or leaks. Check the condition of the element.

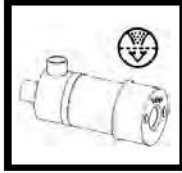

18. Check the electrical charging system.

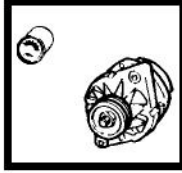

19. Inspect for loose or broken parts or connections.

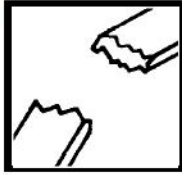

20. Operate the Telescopic Handler and check all functions.



21. Check for any field modification not completed.



22. Recommend to the owner that all necessary corrections be made before the machine is returned to service.



SAFETY INSTRUCTIONS

Before Operation

Carefully follow the operating and maintenance instructions in this manual.

The Bobcat Telescopic Handler is highly maneuverable and compact. It is rugged and useful under a wide variety of conditions. This presents an operator with hazards associated with off highway, rough terrain applications, common with Bobcat Telescopic Handler usage.

The Bobcat Telescopic Handler has an internal combustion engine with resultant heat and exhaust. All exhaust gasses can kill or cause illness so use the Telescopic Handler with adequate ventilation.

The dealer explains the capabilities and restrictions of the Bobcat Telescopic Handler and attachment for each application. The dealer demonstrates the safe operation according to Bobcat instructional materials, which are also available to operators. The dealer can also identify unsafe modifications or use of unapproved attachments. The attachments and buckets are designed for a Rated Load Capacity. They are designed for secure fastening to the Bobcat Telescopic Handler. The user must check with the dealer, or Bobcat literature, to determine safe loads of materials of specified densities for the machine - attachment combination.

The following publications and training materials provide information on the safe use and maintenance of the Bobcat machine and attachments:

- The Delivery Report is used to assure that complete instructions have been given to the new owner and that the machine and attachment is in safe operating condition.
- The Operation & Maintenance Manual delivered with the machine or attachment gives operating information as well as routine maintenance and service procedures. It is a part of the machine and can be stored in a container provided on the machine. Replacement Operation & Maintenance Manuals can be ordered from your Bobcat dealer.
- Machine signs (decals) instruct on the safe operation and care of your Bobcat machine or attachment. The signs and their locations are shown in the Operation & Maintenance Manual. Replacement signs are available from your Bobcat dealer.
- Load Capacity Charts for each attachment are provided in the operator area. These charts indicate the Rated Load Capacity for each attachment at specified boom heights and extensions. Replacement or additional charts for new attachments are available from your Bobcat dealer.

- An Operator's Handbook is fastened to the operator cab of the Telescopic Handler. It's brief instructions are convenient to the operator. The Handbook is available from your dealer in an English edition or one of many other languages. See your Bobcat dealer for more information on translated versions.
- The AEM Safety Manual delivered with the machine gives general safety information.
- The "Safety Training for Operators of the Bobcat Telescopic Handler" course is available through your Bobcat dealer. This course is intended to provide rules and practices of correct operation of the Bobcat Telescopic Handler. The course is available in English and Spanish versions.
- See the PUBLICATIONS AND TRAINING RESOURCES Page in this manual or your Bobcat dealer for Service and Parts Manuals, printed materials, videos, or training courses available. Also check the Bobcat web sites www.training.bobcat.com or www.bobcat.com

The dealer and owner/operator review the recommended uses of the product when delivered. If the owner/operator will be using the machine for a different application(s) he or she must ask the dealer for recommendations on the new use.

SAFETY INSTRUCTIONS (CONT'D)

Safe Operation Is The Operator's Responsibility



Safety Alert Symbol

This symbol with a warning statement means: "Warning, be alert! Your safety is involved!" Carefully read the message that follows.



WARNING

Operator must have instructions before running the machine. Untrained operators can cause injury or death.

W-2001-1285

IMPORTANT

This notice identifies procedures which must be followed to avoid damage to the machine.

I-2019-0284



WARNING

Warnings on the machine and in the manuals are for your safety. Failure to obey warnings can cause injury or death.

W-2044-1285

The Bobcat Telescopic Handler and attachment must be in good operating condition before use.

Check all of the items on the Bobcat Service Schedule Decal under the 8-10 hour column or as shown in the Operation & Maintenance Manual.

Safe Operation Needs A Qualified Operator

For an operator to be qualified, he or she must not use drugs or alcoholic drinks which impair alertness or coordination while working. An operator who is taking prescription drugs must get medical advice to determine if he or she can safely operate a machine.

A Qualified Operator Must Do The Following:

Understand the Written Instructions, Rules and Regulations

- The written instructions from Bobcat Company include the Delivery Report, Operation & Maintenance Manual, Operator's Handbook, Safety Manual and machine signs (decals).
- Check the rules and regulations at your location. The rules may include an employer's work safety requirements. Regulations may apply to local driving requirements or use of a Slow Moving Vehicle (SMV) emblem. Regulations may identify a hazard such as a utility line.

Have Training with Actual Operation

- OSHA Rule 29 CFR 1910.178 (l) requires employers to train employees operating Rough Terrain Forklifts.
- Operator training must consist of a demonstration and verbal instruction. This training is given by your Bobcat dealer before the product is delivered.
- The new operator must start in an area without bystanders or structures and use all the controls until he or she can operate the machine and attachment safely under all conditions of the work area. Always fasten seat belt before operating.
- Operator Training Courses are available from your Bobcat dealer in English and Spanish. They provide information for safe and efficient equipment operation. Safety videos are also available.

Know the Work Conditions

- Know the weight of the materials being handled. Avoid exceeding the Rated Load Capacity of the machine (as indicated on the Load Capacity Charts). Material which is very dense will be heavier than the same volume of less dense material. Reduce the size of load if handling dense material.
- The operator must know any prohibited uses or work areas, for example, he or she needs to know about excessive slopes.
- Know the location of any underground lines. Call local utilities for more information on this.
- Wear tight fitting clothing. Always wear safety glasses when doing maintenance or service. Safety glasses, hearing protection or Front Window Guard are required for some work. See your Bobcat dealer about Bobcat Safety Equipment.

SERIAL NUMBER LOCATIONS

Always use the serial number of the Telescopic Handler when requesting service information or when ordering parts. Early or later models (identification made by serial number) may use different parts, or it may be necessary to use a different procedure in doing a specific service operation.

Telescopic Handler Serial Number

Figure 1



The front, on the right side of the chassis [Figure 1].

Engine Serial Number

Figure 2

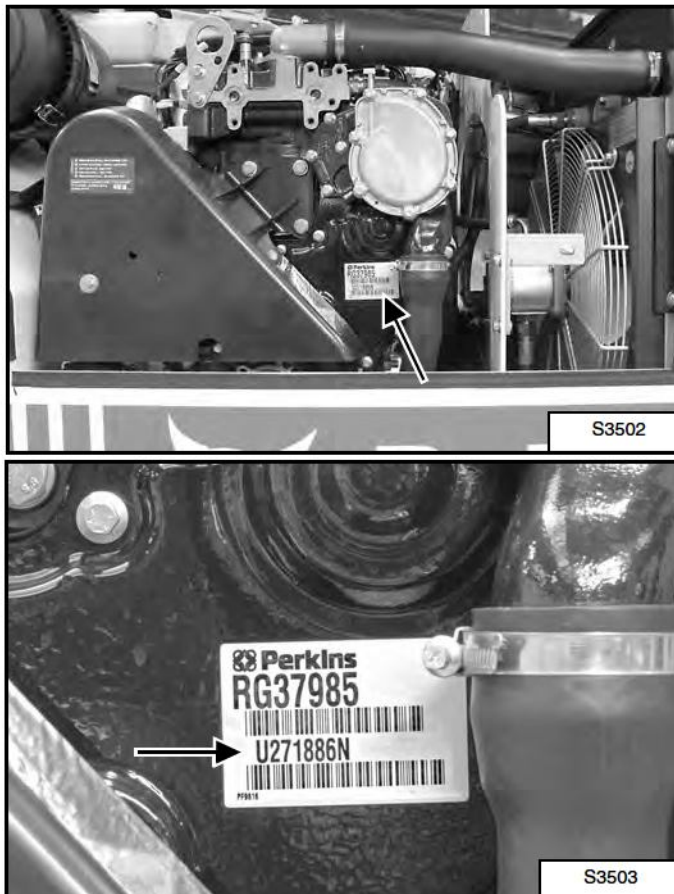

The engine serial number can be found on the cylinder block [Figure 2] in front of you when opening the engine cover. Always use the full number when ordering replacement parts.

Other Serial Numbers

Some components may also have serial numbers. Always use these serial numbers when requesting parts.

Delivery Report

The Delivery Report must be filled out by the dealer and signed by the owner or operator when the Telescopic Handler is delivered. An explanation of the form must be given to the owner. Make sure it is filled out completely [Figure 3].

Figure 3

A sample 'DELIVERY REPORT' form. The form is divided into several sections. At the top right is the title 'DELIVERY REPORT'. Below it is a section for 'WARNING' with a black header and several lines of text. The rest of the form consists of multiple lines of text for recording information. A label 'B-16315' is located at the bottom right of the form.

Identification of the telescopic handler

Reference	Designation
1	Telescopic boom
2	Boom
3	Fuel tank
4	Mirror
5	Operator Cab
6	Battery compartment
7	Boom stop (opt.)
8	Engine exhaust
9	Lights
10	Working lights
11	Engine cover
12	Rotating beacon
13	Pallet forks

For the T3571 and T3571L telescopic handlers [Figure 4].

Figure 4

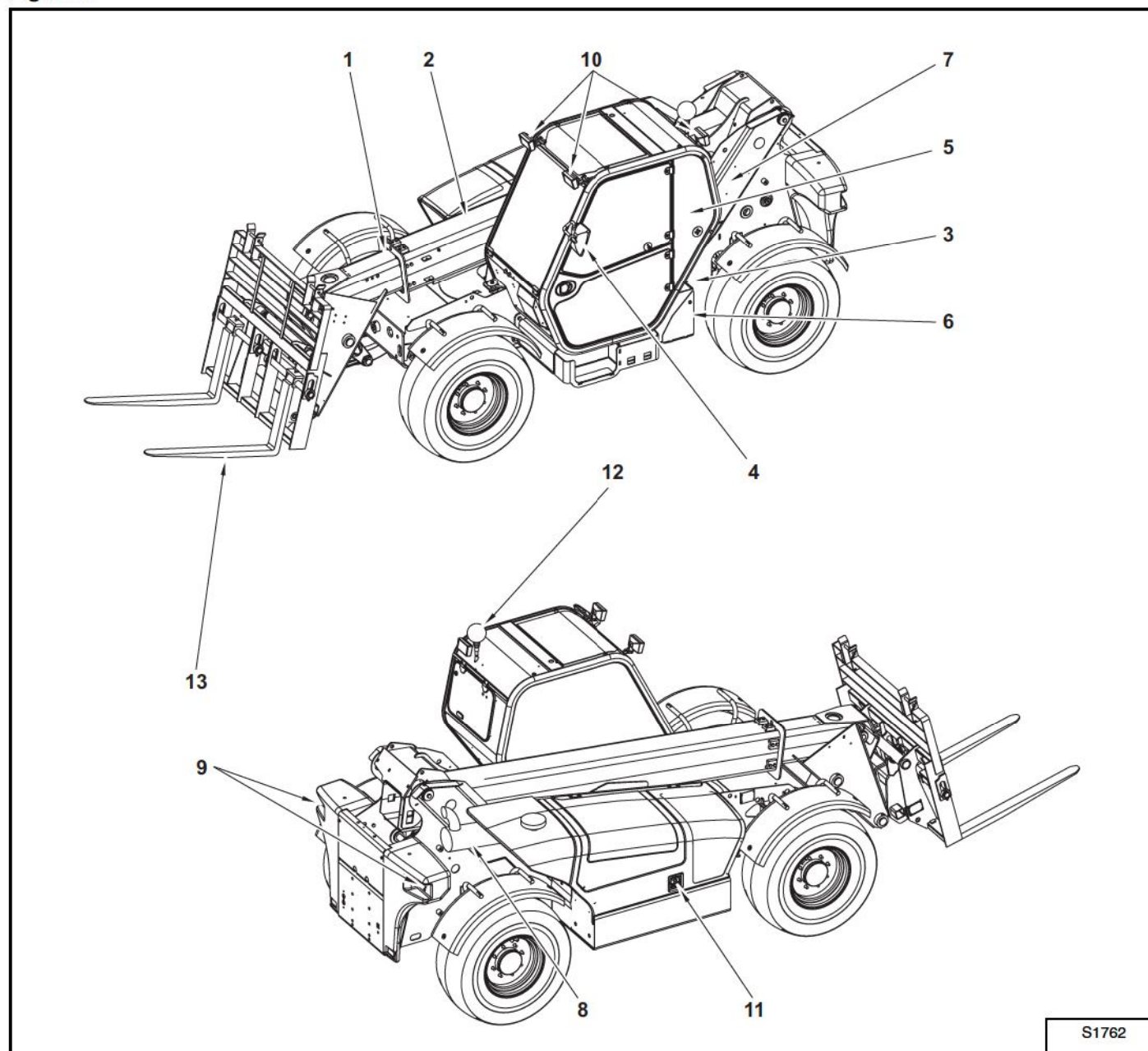

SAFETY AND MAINTENANCE

AIR CLEANER SERVICE10-60-1
 Replacing Filter Element10-60-1

OPTIONAL APPROVED BOOM STOP10-150-1
 Installing The Approved Boom Stop10-150-1
 Removing The Approved Boom Stop10-150-1

AXLES (FRONT AND REAR) (For S/N 362811001 - 362812000, S/N 362911001 - 362912000)10-110-1
 Checking Oil Level (Front Differential)10-110-2
 Checking Oil Level (Planetary Carrier)10-110-1
 Checking Oil Level (Rear Differential)10-110-2
 Draining Oil (Front Differential)10-110-2
 Draining Oil (Planetary Carrier)10-110-1
 Draining Oil (Rear Differential)10-110-2

AXLES (FRONT AND REAR) (For S/N 362812001 and Above, S/N 362912001 and Above)10-111-1
 Checking Oil Level (Front Differential)10-111-2
 Checking Oil Level (Planetary Carrier)10-111-1
 Checking Oil Level (Rear Differential)10-111-2
 Draining Oil (Front Differential)10-111-3
 Draining Oil (Planetary Carrier)10-111-1
 Draining Oil (Rear Differential)10-111-2

ENGINE COOLING SYSTEM.10-70-1
 Checking The Coolant Level10-70-1
 Cleaning The Cooling System.10-70-1
 Replacing The Coolant10-70-2

ENGINE COVER10-160-1
 Opening And Closing The Engine Cover10-160-1

ENGINE LUBRICATION SYSTEM10-90-1
 Checking Engine Oil10-90-1
 Oil Chart10-90-1
 Replacing Oil And Filter.10-90-2

FUEL SYSTEM.10-80-1
 Filling The Fuel Tank10-80-1
 Fuel Filter10-80-1
 Fuel Specifications10-80-1

Continued On Next Page

Dealer Copy -- Not for Resale

SAFETY AND MAINTENANCE (CONT'D)

HYDRAULIC/HYDROSTATIC SYSTEM	10-100-1
Checking And Adding Fluid	10-100-1
Replacing Hydraulic Fluid	10-100-3
LIFTING AND BLOCKING THE TELESCOPIC HANDLER	10-10-1
Procedure	10-10-1
LUBRICATION (For S/N 362811001 - 362812000, S/N 362911001 - 362912000)	10-120-1
Procedure	10-120-1
LUBRICATION (For S/N 362812001 and Above, S/N 362912001 and Above)	10-121-1
Procedure	10-121-1
OPERATOR CAB	10-20-1
Cab Door	10-20-2
Cab Door Window	10-20-2
Emergency Exit	10-20-1
SERVICE SCHEDULE	10-50-1
TIRE MAINTENANCE	10-130-1
Tire Mounting	10-130-1
Tire Rotation	10-130-1
Wheel Nuts	10-130-1
TOWING THE Telescopic Handler	10-40-1
Preparing for towing	10-40-1
Disengaging the hydrostatic transmission	10-40-1
Releasing the handbrake (For S/N 362811001 - 362812000, S/N 362911001 - 368012000):	10-40-2
Releasing the handbrake (For S/N 362812001 and Above, S/N 362912001 and Above):	10-40-2
Towing the Telescopic Handler	10-40-3
TRANSPORTING THE Telescopic Handler	10-30-1
Procedure	10-30-1

LIFTING AND BLOCKING THE TELESCOPIC HANDLER

Procedure

Always park the machine on a level surface.

WARNING

Put jackstands under the front and rear axle before running the engine for service. Failure to use jackstands can allow the machine to fall or move and cause injury or death.

W-2461-0303

Figure 10-10-1

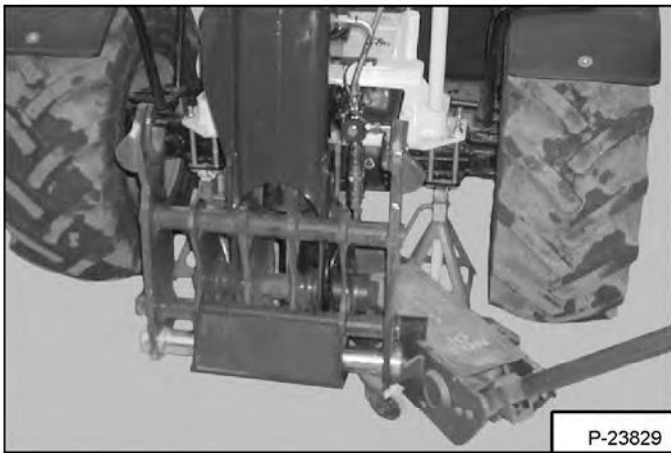

STOP the engine. Put the floor jack under the center of the front axle. Lift the Telescopic Handler and install jackstands [Figure 10-10-1].

Figure 10-10-2



Put the floor jack under the center of the rear axle. Lift the Telescopic Handler and install jackstands [Figure 10-10-2].

OPERATOR CAB

Figure 10-20-1

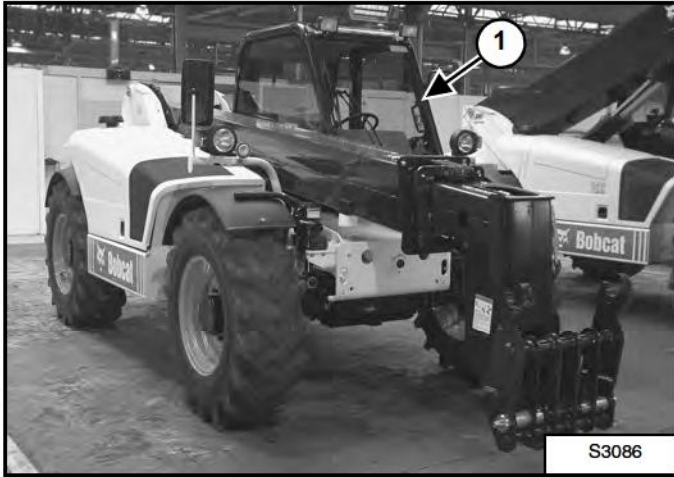

The Telescopic Handler has an operator cab (ROPS and FOPS) (Item 1) [Figure 10-20-1] to protect the operator from rollover and falling objects. Check with your dealer if the operator cab has been damaged. Never operate without right window. The seat belt must be worn for roll over protection.

ROPS/FOPS - Roll Over Protective Structure per SAE J1040 and ISO 3471, and Falling Object Protective Structure per SAE J1043 and ISO 3449 (FOPS Level II).

WARNING

Never modify operator cab by welding, grinding, drilling holes or adding attachments unless instructed to do so by Bobcat. Do not operate without right window. Changes to the cab can cause loss of operator protection from rollover and falling objects, and result in serious injury or death.

W-2396-1202

Emergency Exit

Figure 10-20-2



Turn the handle (Inset) [Figure 10-20-2] and push the rear window open. (Models with enclosed cab only.) Exit through the rear window opening [Figure 10-20-2].

OPERATOR CAB (CONT'D)

Cab Door

Figure 10-20-3

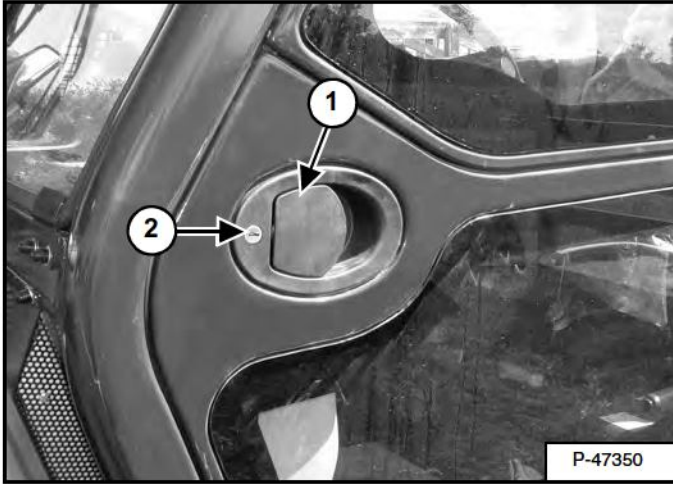
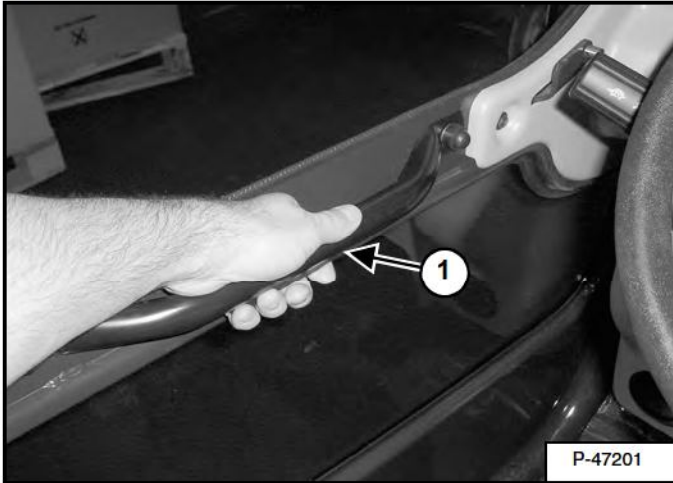

Figure 10-20-4



The cab door can be opened from the outside of the cab using the latch (Item 1) [Figure 10-20-3] and open from the inside of the cab when you squeeze the latch (Item 1) [Figure 10-20-4] (as shown).

The cab door can be locked (Item 2) [Figure 10-20-3] with the start key.

Cab Door Window

Figure 10-20-5

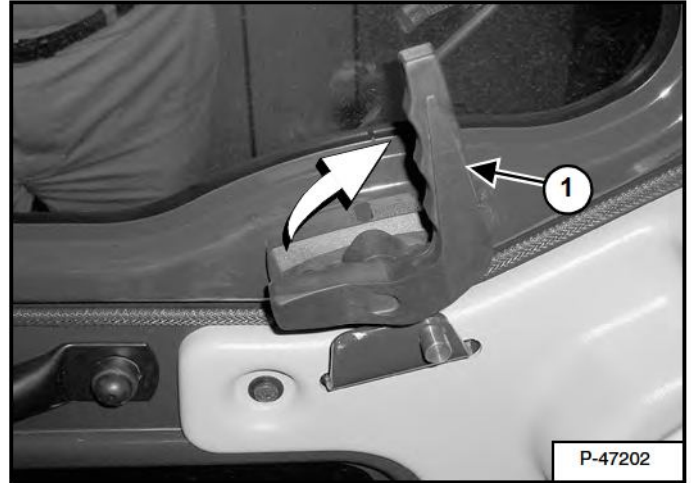

Turn the handle (Item 1) [Figure 10-20-5] (as shown). Push open the window fully until it latches against the cab.

Figure 10-20-6

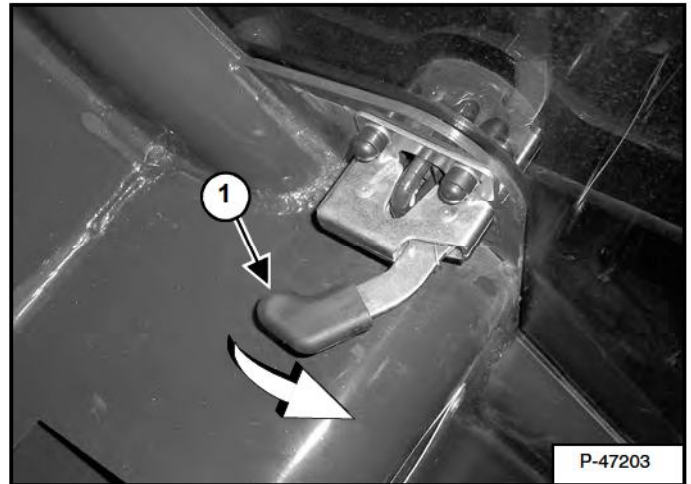

Pull the lever (Item 1) [Figure 10-20-6] inside the cab to disengage the latch and close the window.

TRANSPORTING THE Telescopic Handler

Procedure

Always drive the Telescopic Handler backwards (heavy end up) onto the transport vehicle.

Figure 10-30-1

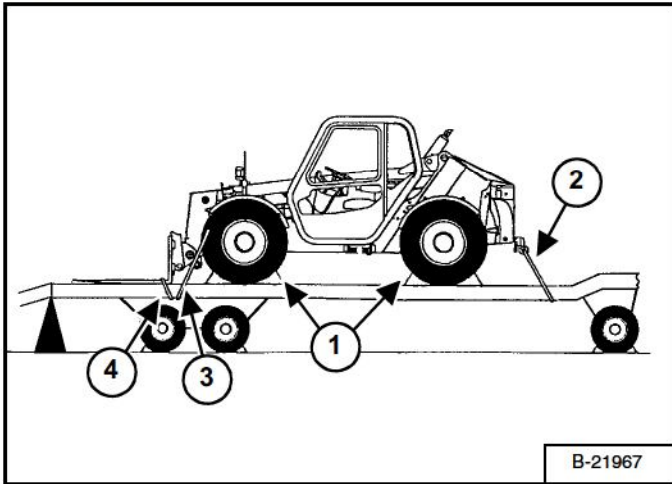

The rear of the trailer must be blocked or supported [Figure 10-30-1] when loading or unloading the Telescopic Handler to prevent the front end of the trailer from raising up.

Be sure the transport and towing vehicles are of adequate size and capacity. (See "Telescopic Handler SPECIFICATIONS" on page SPEC-10-1 for weight of the Telescopic Handler).

Fasten the Telescopic Handler to the transport vehicle to prevent it from moving during sudden stops or when going up or down slopes.

- Block the wheels (Item 1) [Figure 10-30-1].
- Fasten the machine frame to the transport vehicle (Items 2 & 3) [Figure 10-30-1].
- Attach the forks or bucket attachment to the transport vehicle (Item 4) [Figure 10-30-1].

WARNING

Adequately designed ramps of sufficient strength are needed to support the weight of the machine when loading onto a transport vehicle. Wood ramps can break and cause personal injury.

W-2058-0494

TOWING THE TELESCOPIC HANDLER

Preparing for towing

The Telescopic Handler can be towed a short distance such as removing it from mud or loading onto a transport vehicle.

The machine must be prepared before towing.

WARNING

- Before towing, the machine must be immobilised using chocks in front of the wheels or any other means independent of the machine. Do not apply the handbrake.
- After this operation, the handbrake will not work and it will no longer be possible to lock the machine with the hydrostatic transmission.

Disengaging the hydrostatic transmission

It is impossible for oil to circulate in a hydrostatic transmission in a closed circuit when the machine is not running, this operation involves making oil circulation possible:

Figure 10-40-2

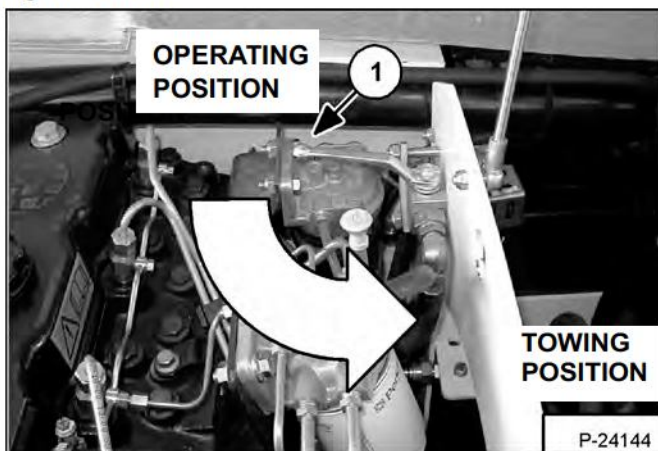

If the optional tow valve is installed, simply raise the engine cover and turn the valve counterclockwise 90° (Item 1) [Figure 10-40-2] to TOWING POSITION.

Follow the below procedure if the optional tow valve is not installed:

Figure 10-40-3

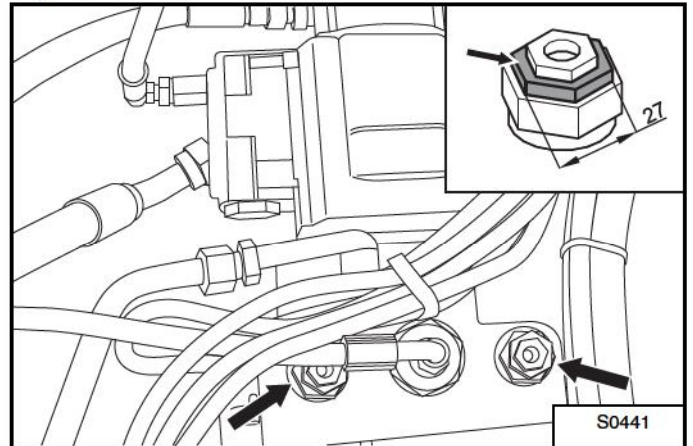

- Locate the two identical multi-function valves on the hydrostatic transmission pump [Figure 10-40-3]. Each valve has three 6-sided nuts of different sizes.
- Unscrew the middle screw of each valve 2.5 turns. This action will bypass the oil flow from the hydrostatic transmission.

TOWING THE TELESCOPIC HANDLER (CONT'D)

Releasing the handbrake (For S/N 362811001 - 362812000, S/N 362911001 - 368012000):

As the machine's handbrake is tightened by lack of pressure, this operation involves releasing the brake mechanically:

- There are three screws at each end of the central part of the front axle, equally distributed 120° from each other. These screws are driven into a counterbore. [Figure 10-40-4] shows the 3 screws of one of the two sides of the front axle. [Figure 10-40-5] shows the position of the screw around the shaft.

Figure 10-40-4

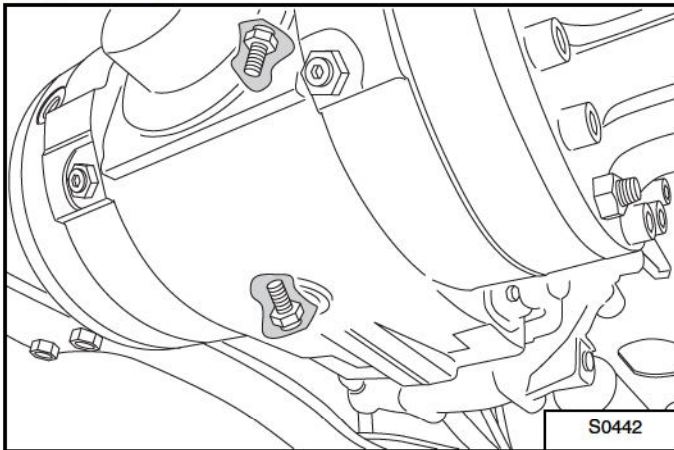
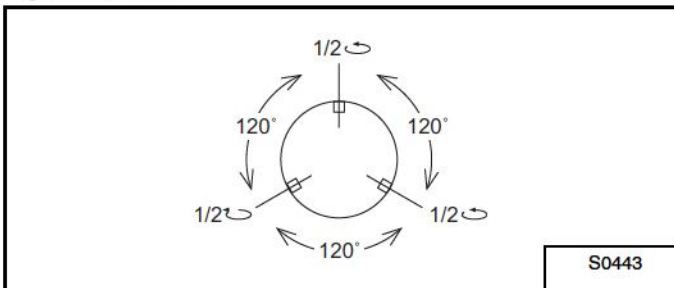

Figure 10-40-5



- The work will first be carried out on the three screws on one side then on the next three.
- Gradually screw (quarter turn by quarter turn) each of the three screws alternatively until they bite (2 - 2.5 turns)

The brakes are now released for towing the vehicle.

Releasing the handbrake (For S/N 362812001 and Above, S/N 362912001 and Above):

As the machine's brakes are tightened by lack of hydraulic pressure (= handbraked position), this operation involves releasing the brakes mechanically. Only the front axle has brakes.

The following procedure describes how to untighten the brakes.

- Release the handbrake. This will open the hydraulic circuit. It is not possible to manually release the brakes when the hydraulic circuit is closed.
- At each end of the central part of the front axle are two screws (see [Figure 10-40-6]). When screwed in, these screws will remove the spring pressure that block the brake disks. [Figure 10-40-7] shows the function of such a screw inside the axle. The work will first be carried out on the two screws on one side of the front axle then on the other side:
 - Loosen the locking nuts of the screws and create some clearance for the screws.
 - Gradually screw (quarter turn by quarter turn) each of the two screws alternatively until they bite.
 - Repeat the above steps on the other side of the front axle.

Figure 10-40-6

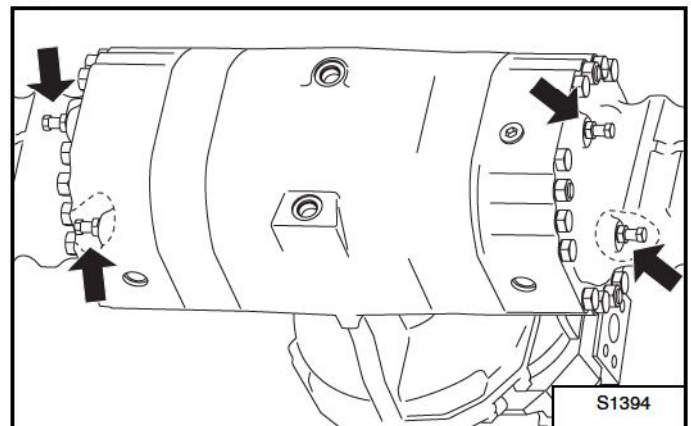
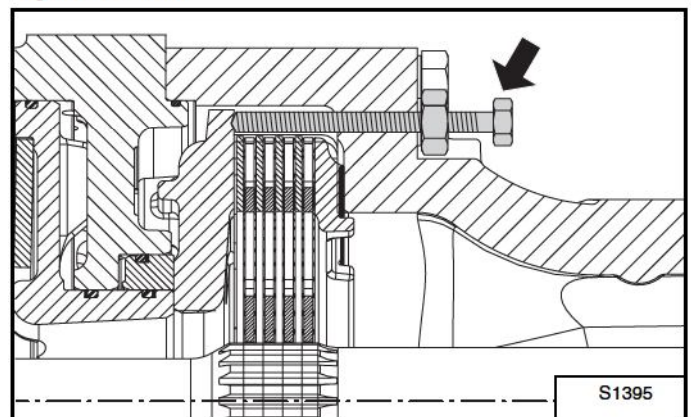

Figure 10-40-7



The brakes are now released for towing the vehicle.

TOWING THE TELESCOPIC HANDLER (CONT'D)

Towing the Telescopic Handler

IMPORTANT

The vehicle will not be able to brake until the screws are returned to their original position.

Tow the Telescopic Handler at slow speed.

After towing:

- Re-engage the hydrostatic transmission by reversing the procedure "Disengaging the hydrostatic transmission" on page 10-40-1.
- Re-activate the brakes by reversing the procedure:
 - for earlier models: "Releasing the handbrake (For S/N 362811001 - 362812000, S/N 362911001 - 368012000):" on page 10-40-2
 - for later models: "Releasing the handbrake (For S/N 362812001 and Above, S/N 362912001 and Above):" on page 10-40-2.

SERVICE SCHEDULE

Maintenance work must be done at regular intervals. Failure to do so will result in excessive wear and early failures. The service schedule is a guide for correct maintenance of the Bobcat Telescopic Handler.

 <b style="font-size: 24px; margin-left: 10px;">WARNING	<p>Instructions are necessary before operating or servicing machine. Read and understand the Operation & Maintenance Manual, Handbook and signs (decals) on machine. Follow warnings and instructions in the manuals when making repairs, adjustments or servicing. Check for correct function after adjustments, repairs or service. Untrained operators and failure to follow instructions can cause injury or death.</p> <p style="text-align: right; font-size: 10px;">W-2003-0199</p>
--	---

Operation	Hours					
	10	50	200	500	800 (4)	1000 (5)
Diesel engine						
Cleaning the air filter's main cartridge (6)						
Replacing the air filter's main cartridge (6)						
Replacing the air filter's safety cartridge (6)						
Checking the cooling fluid level						
Checking the cooling fluid						
Checking the radiators are clean						
Checking the engine oil level						
Draining and changing oil and filter of the engine						
Replacing the lubricating oil filter cartridge						
Checking the state and tension of the alternator belt (2)						
Replacing the fuel filter cartridge						
Hydraulic system						
Checking the hydraulic oil level						
Draining and changing the hydraulic oil						
Replacing the hydraulic filter cartridge						
Replacing the hydraulic oil tank vent valve						
Checking the tightness of hydraulic lines and connections						
Mechanical transmission						
Checking the condition of tyres						
Checking the tyre pressure						
Checking the tightness of wheel nuts (1)						
Checking the vent valves on the two axles are clean						
Lubricating the rear axle rolling element bearings						
Lubricating the axle steering pivots						
Checking the oil level in the front axle central casing				monthly		
Checking the oil level in the reducer box				monthly		
Checking the oil level in the rear axle central casing				monthly		
Checking the oil level on both axles' gear reducers						
Draining and changing the oil in the front axle central casing (3)						
Draining and changing the oil in the reducer box (3)						
Draining and changing the oil on the rear axle central casing (3)						
Draining and changing the oil on two axles gear reducers (3)						
Structure						
Cleaning dust out of the cab filter						
Replacing the cab filter						
Lubricating the hinge pins						
Lubricating the boom's guide rail shoes						
Checking the tightness of screws and bolts						
Checking wear on the boom's guide rail shoes						
Checking wear on flanges and hinge pins						
Electrical system						
Checking the battery fluid level						
Checking the condition of fuses, diodes and relays						
Checking the working order of controls, lighting and signalling						
Checking the working order of indicator lights, indicators and controls						
Checking the condition of electric connections						

- (1) Check wheel nut torque every 8 hours for the first 24 hours.
- (2) First maintenance after 50 hours then according to the table.
- (3) Replace the first time after 100 hrs, then according to the table.

- (4) Or every 12 months.
- (5) Or every 12 months.
- (6) Frequency may vary in certain dusty environments.

Dealer Copy -- Not for Resale

AIR CLEANER SERVICE

Replacing Filter Element

Figure 10-60-1

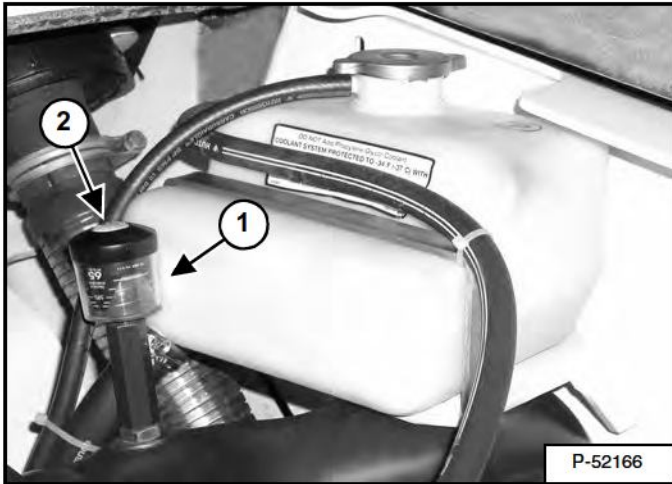

Replace the large (outer) filter element only when the red ring shows in the window of the condition indicator (Item 1) [Figure 10-60-1].

NOTE: Before replacing the filter element, push the button on the condition indicator (Item 2) [Figure 10-60-1]. Start the engine. If the red ring does not show, do not replace the filter element.

Replace the inner filter every third time the outer filter is replaced or when the red ring still shows in the indicator window after the outer filter has been replaced.

Figure 10-60-2

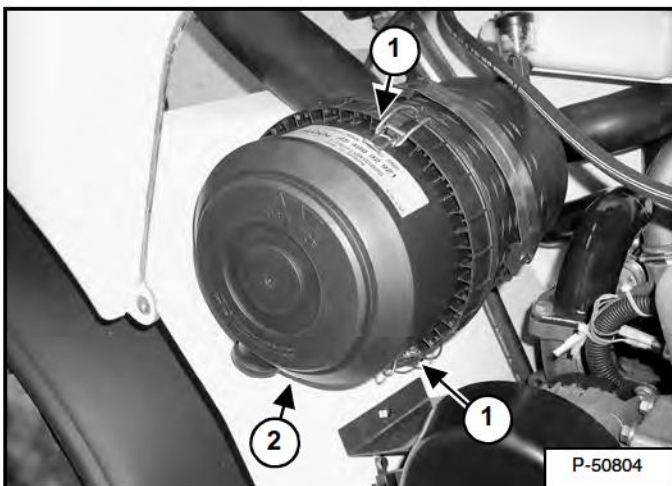

Loosen the filter housing clamps (Item 1) [Figure 10-60-2].

Release the fastener and remove the cover (Item 2) [Figure 10-60-2].

Figure 10-60-3



Pull the element straight out [Figure 10-60-3].

NOTE: Make sure all sealing surfaces are free of dirt and debris.

Install a new outer element.

Install the dust cover and fasten [Figure 10-60-3].

Connect the filter housing clamps.

AIR CLEANER SERVICE (CONT'D)

Replacing Filter Element (Cont'd)

Inner Filter

Remove the outer element.

NOTE: Make sure all sealing surfaces are free of dirt and debris.

Figure 10-60-4

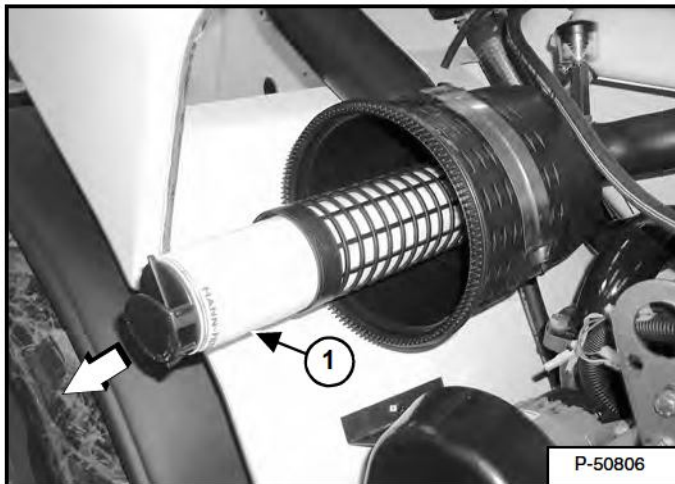

Remove the inner filter (Item 1) [Figure 10-60-4] and install a new element.

Install the outer element.

Install the dust cover and fasten [Figure 10-60-4].

Connect the filter housing clamp (Item 1) [Figure 10-60-4].

ENGINE COOLING SYSTEM

Check the cooling system every day to prevent overheating, loss of performance or engine damage.

! WARNING

Wear safety glasses to prevent eye injury when any of the following conditions exist:

- When fluids are under pressure.
- Flying debris or loose material is present.
- Engine is running.
- Tools are being used.

W-2019-1285

Cleaning The Cooling System

Figure 10-70-1



Open the engine cover (Item 1) [Figure 10-70-1].

Figure 10-70-2

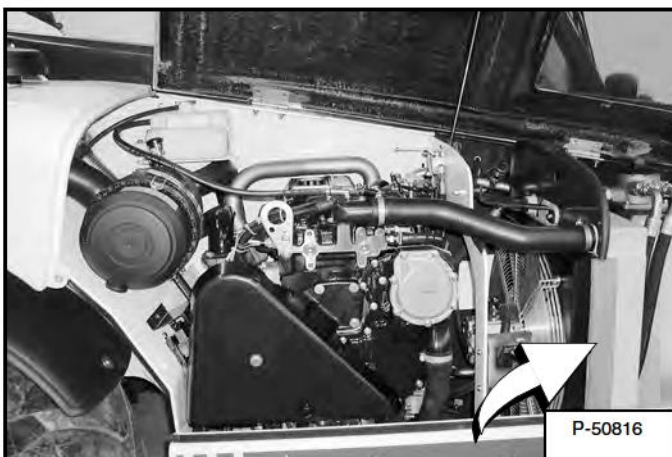

Use low air pressure or water pressure to clean the radiator and oil cooler [Figure 10-70-2].

Checking The Coolant Level

Open the engine cover.

Check the coolant level in the coolant reservoir.

Figure 10-70-3

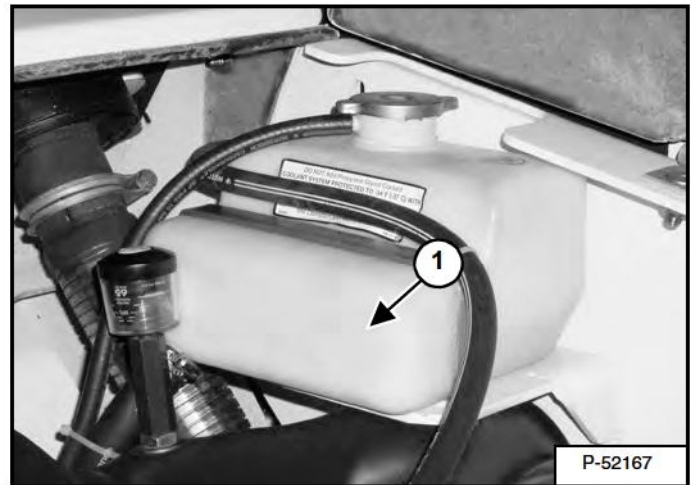

The coolant level must be between the MIN and MAX marks (Item 1) [Figure 10-70-3] on the coolant reservoir when the engine is cold.

Close the engine cover.

IMPORTANT

AVOID ENGINE DAMAGE

Always use the correct ratio of water to antifreeze.

Too much antifreeze reduces cooling system efficiency and may cause serious premature engine damage.

Too little antifreeze reduces the additives which protect the internal engine components; reduces the boiling point and freeze protection of the system.

Always add a premixed solution. Adding full strength concentrated coolant can cause serious premature engine damage.

I-2124-0497

ENGINE COOLING SYSTEM (CONT'D)

Replacing The Coolant

! WARNING

AVOID BURNS

Do not remove radiator cap when the engine is hot. You can be seriously burned.

W-2070-1203

Open the engine cover.

Figure 10-70-4

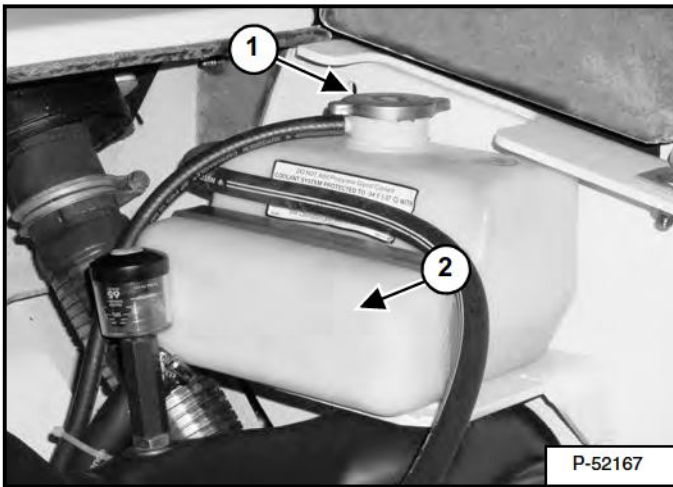

Remove the cap (Item 1) [Figure 10-70-4] from the coolant reservoir.

Remove the fan shield.

IMPORTANT

AVOID ENGINE DAMAGE

Always use the correct ratio of water to anti freeze. Too much antifreeze reduces cooling system efficiency and may cause serious premature engine damage.

Too little antifreeze reduces the additives which protect the internal engine components; reduces the boiling point and freeze protection of the system.

Always add a premixed solution. Adding full strength concentrated coolant can cause serious premature engine damage.

I-2124-0497

Figure 10-70-5

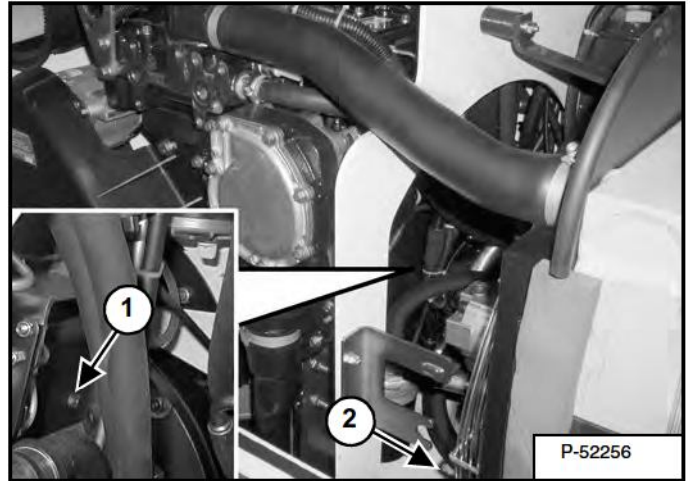

Remove the engine block drain plug (Item 1) [Figure 10-70-5].

Open the drain valve (Item 2) [Figure 10-70-5] and drain all of the coolant into a container. Dispose of used coolant in an environmentally safe manner.

Close the drain valve.

Mix the coolant in a separate container.

NOTE: The Telescopic Handler is factory filled with ethylene glycol coolant.

Add premixed coolant, 50% water and 50% ethylene glycol to the reservoir if the coolant level is low.

One gallon (3,8 L) of ethylene glycol mixed with one gallon (3,8 L) of water is the correct mixture of coolant to provide a -34° F (-37° C) freeze protection.

Use a refractometer to check the condition of ethylene glycol in your cooling system.

Fill the radiator with the premixed coolant. Install the radiator cap.

Add coolant to the reservoir. The coolant level must be between the MIN and MAX marks (Item 2) [Figure 10-70-4] on the coolant reservoir.

Run the engine until it is at operating temperature.

Stop the engine.

Check the coolant level (cold) in the reservoir when cool.

Add coolant as needed.



Suggest:

If the above button click is invalid.

Please download this document

first, and then click the above link

to download the complete manual.

Thank you so much for reading

FUEL SYSTEM

Fuel Specifications

Use only clean, high quality diesel fuel, Grade No. 2 or Grade No. 1.

The following is one suggested blending guideline which should prevent fuel gelling problems in cold temperatures:

TEMP. F° (C°)	NO. 2	NO. 1
+15° (9°)	100%	0%
Down to -20° (-29°)	50%	50%
Below -20° (-29°)	0%	100%

See your fuel supplier for local recommendations.

Filling The Fuel Tank



Stop and cool the engine before adding fuel. **NO SMOKING!** Failure to obey warnings can cause an explosion or fire.

W-2063-0887

Figure 10-80-1

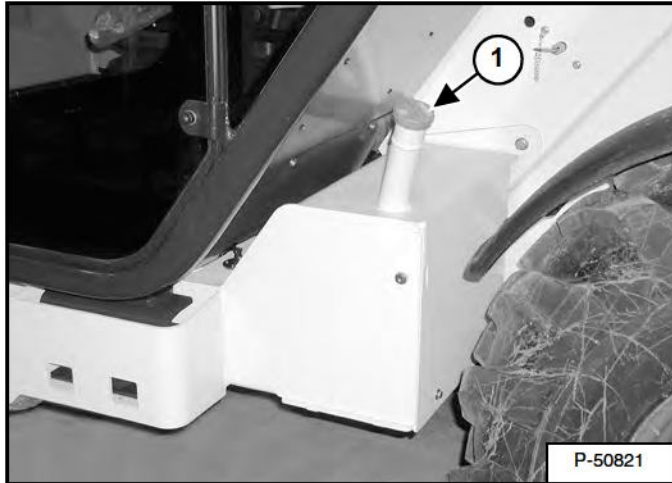

Remove the fuel fill cap (Item 1) [Figure 10-80-1].

Use a clean, approved safety container to add fuel of the correct specifications. Add fuel only in an area that has free movement of air and no open flames or sparks. **NO SMOKING!**

Install and tighten the fuel fill cap [Figure 10-80-1].

Fuel Filter

See “SERVICE SCHEDULE” on page 10-50-1 for the service interval when to clean the sediment bowl.

Figure 10-80-2

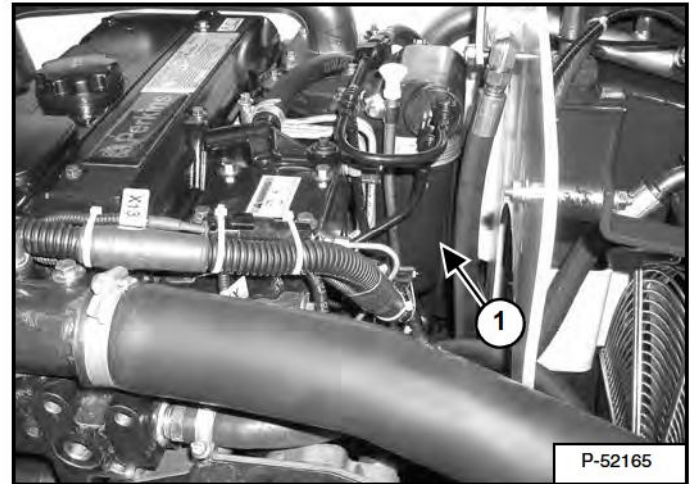

See “SERVICE SCHEDULE” on page 10-50-1 for the service interval when to replace the fuel filter.

Remove the filter element (Item 1) [Figure 10-80-2].

Clean the area around the filter housing.

Put oil on the seal of the new filter element.

Install the fuel filter, and hand tighten.



Always clean up spilled fuel or oil. Keep heat, flames, sparks or lighted tobacco away from fuel and oil. Failure to use care around combustibles can cause explosion or fire which can result in injury or death.

W-2103-1285

<https://www.ebooklibonline.com>

Hello dear friend!

Thank you very much for reading.

Enter the link into your browser.

The full manual is available for immediate download.

<https://www.ebooklibonline.com>