



Bobcat®

Service Manual

T190 Compact Track Loader

S/N A3LN11001 & Above
S/N A3LP11001 & Above

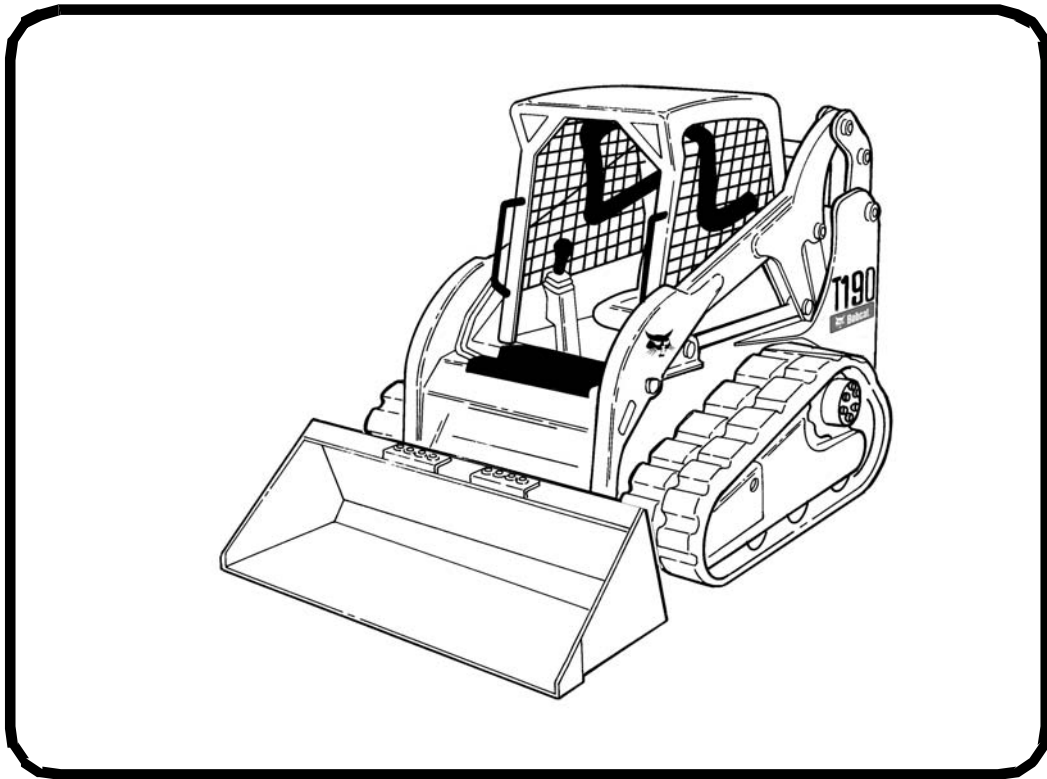

**EQUIPPED WITH
BOBCAT INTERLOCK
CONTROL SYSTEM (BICS™)**

6987052 (8-08)

Printed in U.S.A.



© Bobcat Company 2008

MAINTENANCE SAFETY



WARNING

Instructions are necessary before operating or servicing machine. Read and understand the Operation & Maintenance Manual, Operator's Handbook and signs (decals) on machine. Follow warnings and instructions in the manuals when making repairs, adjustments or servicing. Check for correct function after adjustments, repairs or service. Untrained operators and failure to follow instructions can cause injury or death.

W-2003-0903



Safety Alert Symbol: This symbol with a warning statement, means: "Warning, be alert! Your safety is involved!" Carefully read the message that follows.

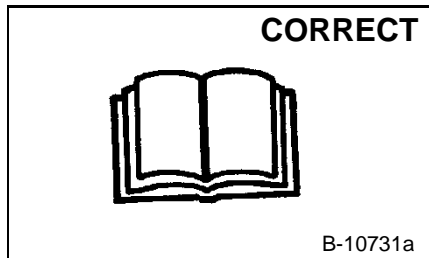

Never service the Bobcat Compact Track Loader without instructions.

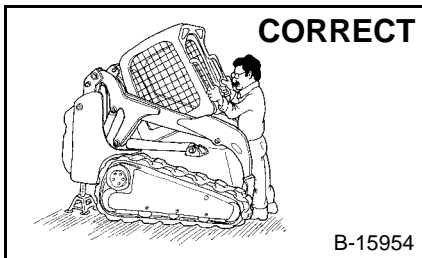

Use the correct procedure to lift or lower operator cab.

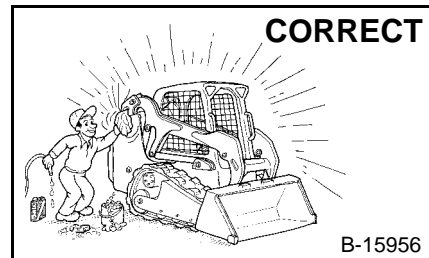

Cleaning and maintenance are required daily.

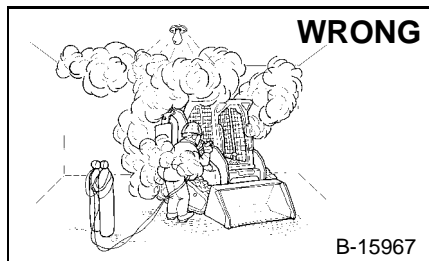

- Have good ventilation when welding or grinding painted parts.
- Wear dust mask when grinding painted parts. Toxic dust and gas can be produced.
- Avoid exhaust fume leaks which can kill without warning. Exhaust system must be tightly sealed.

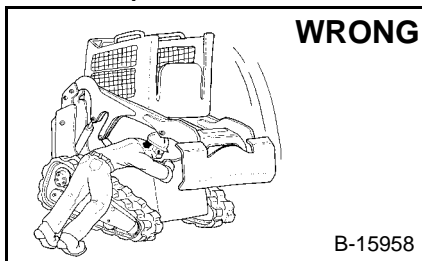

Disconnecting or loosening any hydraulic tubeline, hose, fitting, component or a part failure can cause lift arms to drop. Do not go under lift arms when raised unless supported by an approved lift arm support device. Replace it if damaged.

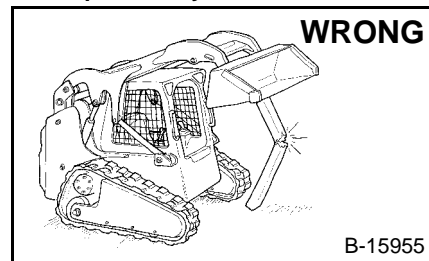

- Never work on loader with lift arms up unless lift arms are held by an approved lift arm support device. Replace if damaged.
- Never modify equipment or add attachments not approved by Bobcat Company.

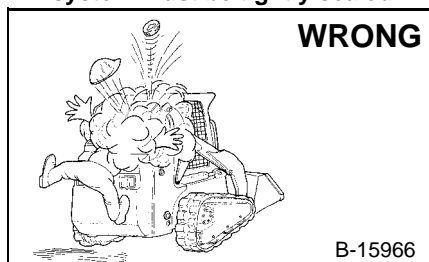

- Stop, cool and clean engine of flammable materials before checking fluids.
- Never service or adjust loader with the engine running unless instructed to do so in the manual.
- Avoid contact with leaking hydraulic fluid or diesel fuel under pressure. It can penetrate the skin or eyes.
- Never fill fuel tank with engine running, while smoking or when near open flame.

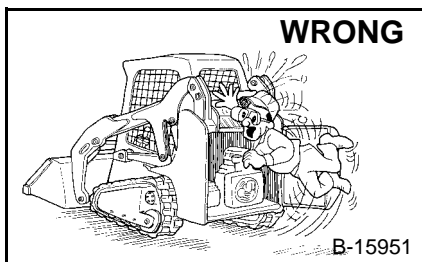

- Keep body, jewelry and clothing away from moving parts, electrical contact, hot parts and exhaust.
- Wear eye protection to guard from battery acid, compressed springs, fluids under pressure and flying debris when engines are running or tools are used. Use eye protection approved for type of welding.
- Keep rear door closed except for service. Close and latch door before operating the loader.

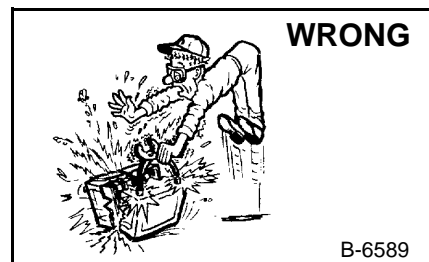

- Lead-acid batteries produce flammable and explosive gases.
- Keep arcs, sparks, flames and lighted tobacco away from batteries.
- Batteries contain acid which burns eyes or skin on contact. Wear protective clothing. If acid contacts body, flush well with water. For eye contact flush well and get immediate medical attention.

Maintenance procedures which are given in the Operation & Maintenance Manual can be performed by the owner/operator without any specific technical training. Maintenance procedures which are **not** in the Operation & Maintenance Manual must be performed **ONLY BY QUALIFIED BOBCAT SERVICE PERSONNEL**. Always use **genuine Bobcat replacement parts**. The Service Safety Training Course is available from your Bobcat dealer.

ALPHABETICAL INDEX

ACCESS PANEL (INSIDE)	50-01	EXHAUST GAS RECIRCULATION	
ACCESS PANEL (INSIDE) (SJC)	50-01	(EGR) SYSTEM.....	70-01
AIR CLEANER	70-01		
AIR CLEANER SERVICE	10-01	FINAL DRIVE TRANSMISSION (CHAINCASE) ..	10-01
AIR CONDITIONING SYSTEM FLOW	80-01	FLYWHEEL AND HOUSING	70-01
ALTERNATOR	60-01	FLYWHEEL RPM SENSOR	60-01
		FRONT AUXILIARY HYD. COUPLER BLOCK	20-01
BACK-UP SYSTEM	60-01	FUEL SYSTEM.....	10-01, 70-01
BATTERY	60-01	FUEL TANK	50-01
BLOWER FAN	80-01		
BOBCAT INTERLOCK CONTROL		HEATER COIL.....	80-01
SYSTEM (BICS)	60-01	HEATER VALVE	80-01
BOBCAT CONTROLLER (ACS)	60-01	HIGH FLOW VALVE	20-01
BOBCAT CONTROLLER (GATEWAY AND		HYDRAULIC CONNECTION SPECS.	SPEC-01
AUXILIARY)	60-01	HYDRAULIC CONTROL VALVE	20-01
BOBCAT CONTROLLER (SJC) (DRIVE)	60-01	HYD./HYDRO FLUID SPECIFICATIONS	SPEC-01
BOB-TACH (HAND LEVER)	10-01, 50-01	HYDRAULIC FLUID RESERVOIR	20-01
BOB-TACH (POWER).....	10-01, 50-01	HYDRAULIC/HYDROSTATIC FILTERS	20-01
BRAKE	40-01	HYDRAULIC/HYDROSTATIC SYSTEM.....	10-01
BUCKET POSITION VALVE	20-01	HYDRAULIC PUMP (STANDARD).....	20-01
		HYDRAULIC PUMP (STANDARD) (HIGH FLOW) ..	20-01
CALIBRATION	60-01	HYDRAULIC PUMP (SJC) (HIGH FLOW).....	20-01
CAMSHAFT AND TIMING GEARS.....	70-01	HYDRAULIC PUMP (SJC)	20-01
CHAINCASE	40-01	HYDRAULIC SYSTEM INFORMATION	20-01
CHARGE PRESSURE	30-01	HYDROSTATIC MOTOR	30-01
COMPRESSOR	80-01	HYDROSTATIC MOTOR CARRIER.....	30-01
CONDENSER	80-01	HYDROSTATIC PUMP	30-01
CONTROL HANDLE/LEVER	50-01	HYDROSTATIC PUMP (SJC)	30-01
CONTROL HANDLE/LEVER (ACS)	50-01	HYDROSTATIC SYSTEM INFORMATION	30-01
CONTROL HANDLE/LEVER (SJC).....	50-01		
CONTROL PANEL	50-01	INSTRUMENT PANELS	60-01
CONTROL PANEL (SJC).....	50-01		
CONTROL PANEL SETUP	60-01	LIFT ARMS.....	50-01
CONTROL PEDALS AND LINKAGE	50-01	LIFT ARM BYPASS CONTROL VALVE	20-01
CONTROL PEDALS (ACS)	50-01	LIFT ARM SUPPORT DEVICE	10-01
CONTROL SYSTEM (ACS).....	50-01	LIFTING AND BLOCKING THE LOADER.....	10-01
CONVERSIONS	SPEC-01	LIGHTS	60-01
CRANKSHAFT AND PISTONS	70-01	T190 LOADER SPECIFICATIONS.....	SPEC-01
CYLINDER (LIFT)	20-01	LOADER STORAGE AND RETURN TO SERVICE	10-01
CYLINDER (BOB-TACH)	20-01	LUBRICATING THE LOADER.....	10-01
CYLINDER (TILT)	20-01	LUBRICATION SYSTEM.....	70-01
CYLINDER HEAD.....	70-01		
		MAIN RELIEF VALVE	20-01
DIAGNOSTICS SERVICE CODES	60-01	MAINTENANCE CLOCK	60-01
DRIVE BELT	30-01	MUFFLER.....	70-01
DRIVE COMPONENTS	40-01		
		OIL COOLER.....	20-01
ELECTRICAL SYSTEM INFORMATION	60-01	OPERATOR CAB	10-01, 50-01
ELECTRICAL/HYRAULIC CONTROLS.....	60-01	OPERATOR SEAT (SUSPENSION).....	50-01
ELECTRICAL/HYRAULIC CONTROLS (SJC).....	60-01		
ENGINE	70-01	PASSWORD SETUP (IF EQUIPPED WITH	
ENGINE COOLING SYSTEM.....	10-01, 70-01	KEYLESS START).....	60-01
ENGINE INFORMATION	70-01	PIVOT PINS	10-01
ENGINE LUBRICATION SYSTEM.....	10-01	POWER BOB-TACH (OPTION).....	10-01, 50-01
ENGINE SPEED CONTROL (SJC)	70-01	POWER BOB-TACH BLOCK.....	20-01
EVAPORATOR COIL	80-01	PRESSURE RELIEF VALVE	80-01
EVAPORATOR/HEATER UNIT	80-01	PRESSURE SWITCH.....	80-01

<https://www.ebooklibonline.com>

Hello dear friend!

Thank you very much for reading.

Enter the link into your browser.

The full manual is available for immediate download.

<https://www.ebooklibonline.com>

ALPHABETICAL INDEX (CONT'D)

REAR AUXILIARY DIVERTER VALVE	20-01
REAR DOOR	50-01
REAR GRILL	50-01
RECEIVER/DRIER	80-01
REGULAR MAINTENANCE	80-01
REMOTE START TOOL KIT-MEL1563	10-01
REMOTE START TOOL (SERVICE TOOL) KIT-6689779	10-01
SEAT BAR	50-01
SEAT BAR SENSOR	60-01
SERVICE PC (LAPTOP COMPUTER)	60-01
SERVICE SCHEDULE	10-01
SPARK ARRESTOR MUFFLER	10-01
SPEED SENSORS (SJC)	60-01
STARTER	60-01
STEERING DRIFT COMPENSATION	60-01
STOPPING THE ENGINE AND LEAVING THE LOADER	10-01
SYSTEM CHARGING AND RECLAMATION	80-01
TEMPERATURE/PRESSURE	80-01
THERMOSTAT	80-01
TIRE MAINTENANCE	10-01
TORQUE SPECIFICATIONS FOR BOLTS	SPEC-01
TOWING THE LOADER	10-01
TRACTION LOCK	60-01
TRANSPORTING LOADER ON A TRAILER	10-01
TROUBLESHOOTING	80-01
TURBOCHARGER	70-01
WINDOW (FRONT DOOR)	50-01
WINDOW (REAR)	50-01
WINDOW (SIDE)	50-01
WINDOW (TOP)	50-01

CONTENTS

FOREWORD.....	II
SAFETY INSTRUCTIONS	V
FIRE PREVENTION	VII
SERIAL NUMBER LOCATION	IX
DELIVERY REPORT.....	X
LOADER IDENTIFICATION	XI
SAFETY & MAINTENANCE	10-01
HYDRAULIC SYSTEM	20-01
HYDROSTATIC SYSTEM.....	30-01
DRIVE SYSTEM	40-01
MAIN FRAME	50-01
ELECTRICAL SYSTEM & ANALYSIS.....	60-01
ENGINE SERVICE	70-01
HEATING, VENTILATION, AIR CONDITIONING	80-01
SPECIFICATIONS.....	SPEC-01

**SAFETY &
MAINTENANCE**

**HYDRAULIC
SYSTEM**

**HYDROSTATIC
SYSTEM**

**DRIVE
SYSTEM**

MAIN FRAME

**ELECTRICAL
SYSTEM &
ANALYSIS**

**ENGINE
SERVICE**

HVAC

SPECIFICATIONS

FOREWORD

This manual is for the Bobcat loader mechanic. It provides necessary servicing and adjustment procedures for the Bobcat loader and its component parts and systems. Refer to the Operation & Maintenance Manual for operating instructions, starting procedure, daily checks, etc.

A general inspection of the following items must be made after the loader has had service or repair:

1. Check that the ROPS/FOPS (Including side screens) is in good condition and is not modified.

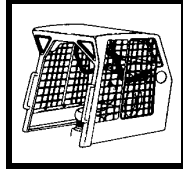

2. Check that ROPS mounting hardware is tightened and is Bobcat approved.



3. The seat belt must be correctly installed, functional and in good condition.

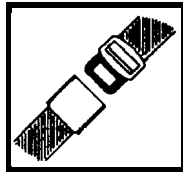

4. The seat bar must be correctly adjusted, clean and lubricated.

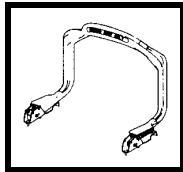

5. Check lift arm support device, replace if damaged.

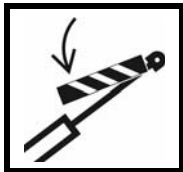

6. Machine signs (decals) must be legible and in the correct location.



7. Steering levers, hand controls and foot pedals must return to neutral (as applicable).

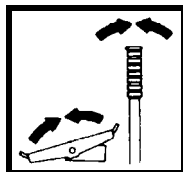

8. Check for correct function of the work lights.



9. The parking brake must function correctly.

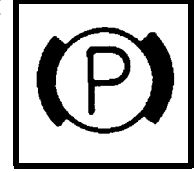

10. Enclosure door latches must open and close freely.

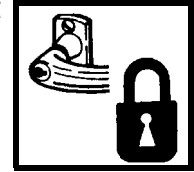

11. Bob-Tach wedges and linkages must function correctly and be in good condition.

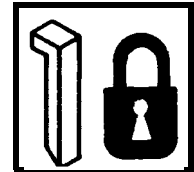

12. Safety treads must be in good condition.

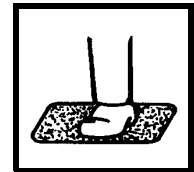

13. Check for correct function of indicator lamps.

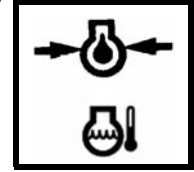

14. Check hydraulic fluid level, engine oil level and fuel supply.

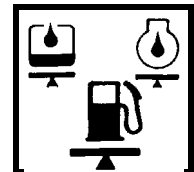

15. Inspect for fuel, oil or hydraulic fluid leaks.

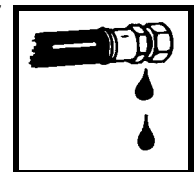

16. Lubricate the loader.

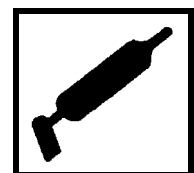

FW SSL-0308 SM

17. Check the condition of the battery and cables.



18. Inspect the air cleaner for damage or leaks. Check the condition of the element.

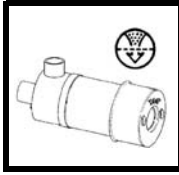

19. Check the electrical charging system.

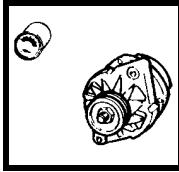

20. Check tires for wear and pressure. Check tracks for wear and tension. Use only approved tires or tracks.

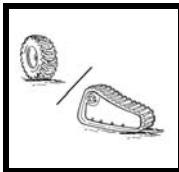

21. Inspect for loose or broken parts or connections.

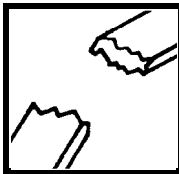

22. Check for any field modification not completed.



23. Operate the machine and check all functions.

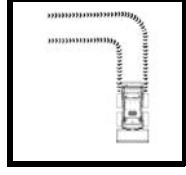

24. Check for correct function of the Bobcat Interlock Control System (BICST™) before the machine is returned to the customer.

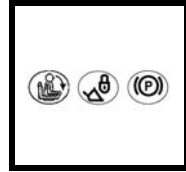

25. Check function or condition of all equipped options and accessories (examples: back-up alarm, fire extinguisher, rotating beacon, lift kits, etc.).



26. Recommend to the owner that all necessary corrections be made before the machine is returned to service.

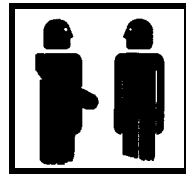

**CALIFORNIA
PROPOSITION 65 WARNING**
Diesel engine exhaust and some of its constituents are known to the state of California to cause cancer, birth defects and other reproductive harm.

SAFETY INSTRUCTIONS



Safety Alert Symbol

This symbol with a warning statement means: **“Warning, be alert! Your safety is involved!”**
Carefully read the message that follows.



WARNING

Instructions are necessary before operating or servicing machine. Read and understand the Operation & Maintenance Manual, Operator's Handbook and signs (decals) on machine. Follow warnings and instructions in the manuals when making repairs, adjustments or servicing. Check for correct function after adjustments, repairs or service. Untrained operators and failure to follow instructions can cause injury or death.

W-2003-0903

IMPORTANT

This notice identifies procedures which must be followed to avoid damage to the machine.

I-2019-0284



DANGER

The signal word **DANGER** on the machine and in the manuals indicates a hazardous situation which, if not avoided, will result in death or serious injury.

D-1002-1107



WARNING

The signal word **WARNING** on the machine and in the manuals indicates a potentially hazardous situation which, if not avoided, could result in death or serious injury.

W-2044-1107

The following publications provide information on the safe use and maintenance of the Bobcat machine and attachments:

- The Delivery Report is used to assure that complete instructions have been given to the new owner and that the machine is in safe operating condition.
- The Operation & Maintenance Manual delivered with the machine or attachment contains operating information as well as routine maintenance and service procedures. It is a part of the machine and can be stored in a container provided on the machine. Replacement Operation & Maintenance Manuals can be ordered from your Bobcat dealer.
- Machine signs (decals) instruct on the safe operation and care of your Bobcat machine or attachment. The signs and their locations are shown in the Operation & Maintenance Manual. Replacement signs are available from your Bobcat dealer.
- An Operator's Handbook fastened to the operator cab. It's brief instructions are convenient to the operator. The handbook is available from your dealer in an English edition or one of many other languages. See your Bobcat dealer for more information on translated versions.
- The AEM Safety Manual delivered with the machine gives general safety information.
- The Service Manual and Parts Manual are available from your dealer for use by mechanics to do shop-type service and repair work.
- The Skid-Steer Loader Operator Training Course is available through your local dealer or at www.training.bobcat.com or www.bobcat.com. This course is intended to provide rules and practices of correct operation of the Skid-Steer Loader. The course is available in English and Spanish versions.
- Service Safety Training Courses are available from your Bobcat dealer or at www.training.bobcat.com or www.bobcat.com. They provide information for safe and correct service procedures.
- The Skid-Steer Loader Safety Video is available from your Bobcat dealer or at www.training.bobcat.com or www.bobcat.com.

SI SSL-0308 SM

FIRE PREVENTION



Maintenance

The machine and some attachments have components that are at high temperatures under normal operating conditions. The primary source of high temperatures is the engine and exhaust system. The electrical system, if damaged or incorrectly maintained, can be a source of arcs or sparks.

Flammable debris (leaves, straw, etc.) must be removed regularly. If flammable debris is allowed to accumulate, it can cause a fire hazard. Clean often to avoid this accumulation. Flammable debris in the engine compartment is a potential fire hazard.

The operator's area, engine compartment and engine cooling system must be inspected every day and cleaned if necessary to prevent fire hazards and overheating.

All fuels, most lubricants and some coolants mixtures are flammable. Flammable fluids that are leaking or spilled onto hot surfaces or onto electrical components can cause a fire.

Operation

Do not use the machine where exhaust, arcs, sparks or hot components can contact flammable material, explosive dust or gases.

Electrical



Check all electrical wiring and connections for damage. Keep the battery terminals clean and tight. Repair or replace any damaged part or wires that are loose or frayed.

Battery gas can explode and cause serious injury. Use the procedure in the Operation & Maintenance Manual for connecting the battery and for jump starting. Do not jump start or charge a frozen or damaged battery. Keep any open flames or sparks away from batteries. Do not smoke in battery charging area.

Hydraulic System

Check hydraulic tubes, hoses and fittings for damage and leakage. Never use open flame or bare skin to check for leaks. Hydraulic tubes and hoses must be properly routed and have adequate support and secure clamps. Tighten or replace any parts that show leakage.

Always clean fluid spills. Do not use gasoline or diesel fuel for cleaning parts. Use commercial nonflammable solvents.

Fueling



Stop the engine and let it cool before adding fuel. No smoking! Do not refuel a machine near open flames or sparks. Fill the fuel tank outdoors.

Starting

Do not use ether or starting fluids on any engine that has glow plugs. These starting aids can cause explosion and injure you or bystanders.

Use the procedure in the Operation & Maintenance Manual for connecting the battery and for jump starting.

Spark Arrestor Exhaust System

The spark arrestor exhaust system is designed to control the emission of hot particles from the engine and exhaust system, but the muffler and the exhaust gases are still hot.

Check the spark arrestor exhaust system regularly to make sure it is maintained and working properly. Use the procedure in the Operation & Maintenance Manual for cleaning the spark arrestor muffler (if equipped).

FIRE PREVENTION (CONT'D)

Welding And Grinding

Always clean the machine and attachment, disconnect the battery, and disconnect the wiring from the Bobcat controllers before welding. Cover rubber hoses, battery and all other flammable parts. Keep a fire extinguisher near the machine when welding.

Have good ventilation when grinding or welding painted parts. Wear dust mask when grinding painted parts. Toxic dust or gas can be produced.

Dust generated from repairing nonmetallic parts such as hoods, fenders or covers can be flammable or explosive. Repair such components in a well ventilated area away from open flames or sparks.

Fire Extinguishers

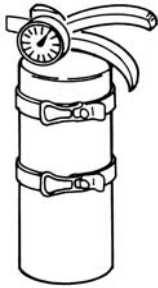

Know where fire extinguishers and first aid kits are located and how to use them. Inspect the fire extinguisher and service the fire extinguisher regularly. Obey the recommendations on the instructions plate.

SERIAL NUMBER LOCATION

Always use the serial number of the loader when requesting service information or when ordering parts. Early or later models (identification made by serial number) may use different parts, or it may be necessary to use a different procedure in doing a specific service operation.

Loader Serial Number

Figure 1

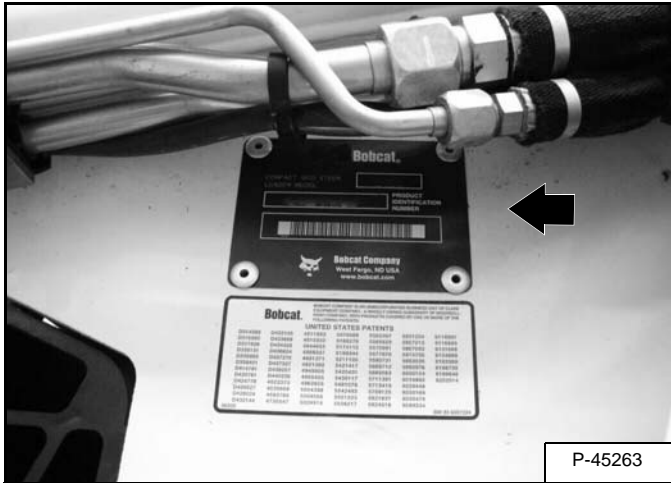

The loader serial number plate is located on the outside of the loader frame [Figure 1].

Explanation of loader Serial Number:

XXXX	XXXXX
Model 1.-Model/ Engine Combination	Model 2.-Production Sequence (Series)

1. The four digit Model/Engine Combination Module number identifies the model number and engine combination.
2. The five digit Production Sequence Number identifies the order which the loader is produced.

Engine Serial Number

Figure 2

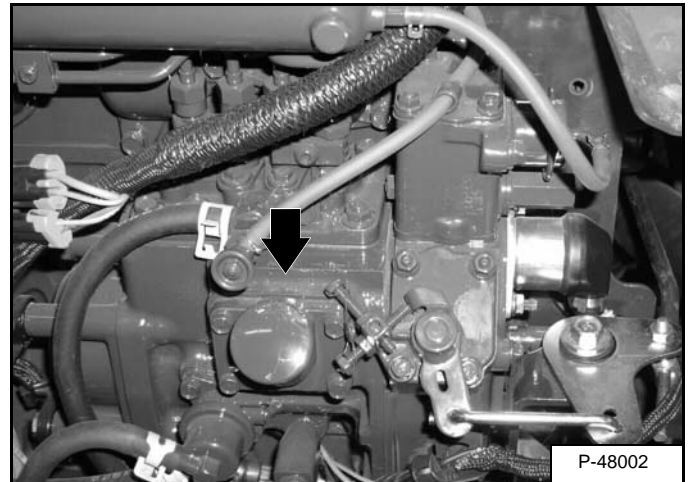

The engine serial number is in the location shown [Figure 2].

DELIVERY REPORT

Figure 3

The diagram shows a form layout for a delivery report. It includes a title 'DELIVERY REPORT' at the top right, a 'WARNING' section with a black header, and various text entry areas represented by horizontal lines. A reference code 'B-16315' is located in the bottom right corner of the form's frame.

The Delivery Report must be filled out by the dealer and signed by the owner or operator when the Bobcat loader is delivered. An explanation of the form must be given to the owner. Make sure it is filled out completely **[Figure 3]**.

LOADER IDENTIFICATION

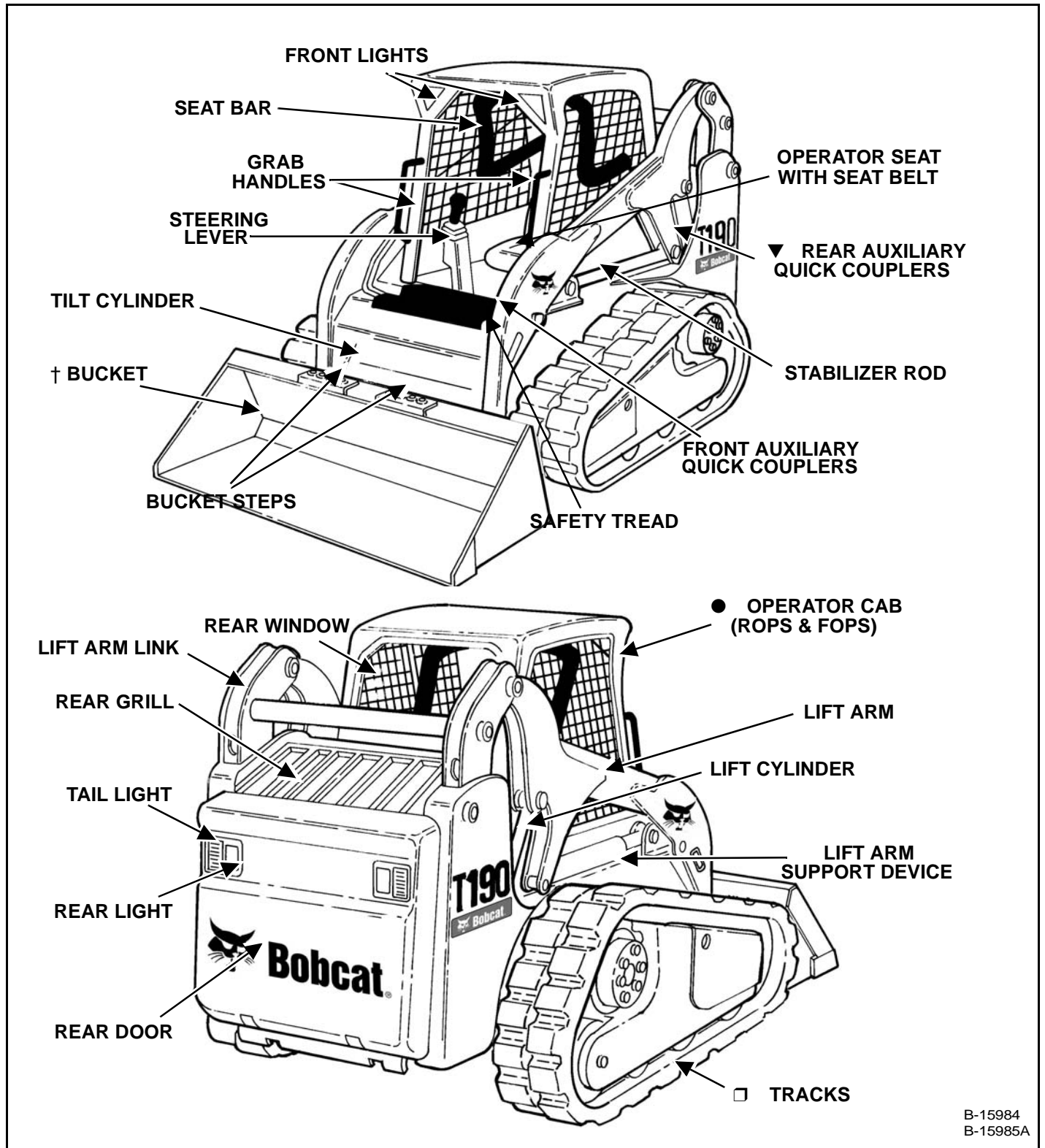

B-15984
B-15985A

- ▼ OPTIONAL OR FIELD ACCESSORY (Not Standard Equipment)
- TRACKS - Optional tracks are available.
- † Bucket - Several different buckets and other attachments are available for this machine.
- ROPS, FOPS - Roll Over Protective Structure, per SAE J1040 and ISO 3471, and Falling Object Protective Structure per ISO 3449, Level I. Level II is available. Extra insulated cab is available as an option (Reduced noise level).

AIR CLEANER SERVICE 10-80-1
 Replacing Filter Elements 10-80-1

BOB-TACH (HAND LEVER) 10-130-1
 Inspection And Maintenance 10-130-1

BOB-TACH (POWER) 10-131-1
 Inspection And Maintenance 10-131-1

ENGINE COOLING SYSTEM 10-90-1
 Checking Level 10-90-2
 Cleaning. 10-90-1
 Removing And Replacing Coolant. 10-90-2

ENGINE LUBRICATION SYSTEM 10-110-1
 Checking And Adding Engine Oil. 10-110-1
 Engine Oil Chart. 10-110-1
 Removing And Replacing Oil And Filter. 10-110-1

FUEL SYSTEM 10-100-1
 Filling The Fuel Tank 10-100-2
 Fuel Filter. 10-100-3
 Fuel Specifications. 10-100-1
 Removing Air From The Fuel System 10-100-3

HYDRAULIC / HYDROSTATIC SYSTEM 10-120-1
 Breather Cap 10-120-6
 Checking And Adding Fluid 10-120-1
 Hydraulic / Hydrostatic Fluid Chart 10-120-1
 Removing And Replacing Hydraulic Charge Filter. 10-120-5
 Removing And Replacing Case Drain Filters. 10-120-4
 Removing And Replacing Hydraulic Fluid 10-120-2
 Removing And Replacing Hydraulic / Hydrostatic Filter 10-120-3

LIFT ARM SUPPORT DEVICE 10-20-1
 Installing. 10-20-1
 Removing. 10-20-2

LIFTING AND BLOCKING THE LOADER 10-10-1
 Procedure 10-10-1

LOADER STORAGE AND RETURN TO SERVICE 10-170-1
 Return To Service 10-170-1
 Storage 10-170-1

Continued On Next Page

SAFETY & MAINTENANCE (CONT'D)

LUBRICATING THE LOADER	10-140-1
Lubrication Locations	10-140-1
OPERATOR CAB	10-30-1
Cab Door Sensor	10-30-4
Description	10-30-1
Lowering	10-30-3
Raising	10-30-2
PIVOT PINS	10-160-1
Inspection And Maintenance	10-160-1
REMOTE START TOOL KIT-MEL1563	10-60-1
Remote Start Procedure	10-60-4
Remote Start Tool - MEL1563	10-60-1
Service Tool Harness Communicator - MEL1566	10-60-3
Service Tool Harness Control - MEL1565	10-60-2
REMOTE START TOOL (SERVICE TOOL) KIT - 6689779 ..	10-61-1
Computer Service Tool Harness - 6689746	10-61-4
Description	10-61-1
Loader Service Tool Harness - 6689747	10-61-3
Remote Start Procedure	10-61-5
Remote Start Tool (Service Tool) - 6689778	10-61-2
SERVICE SCHEDULE	10-70-1
Chart	10-70-1
SPARK ARRESTOR MUFFLER	10-150-1
Cleaning Procedure	10-150-1
STOPPING THE ENGINE AND LEAVING THE LOADER ..	10-180-1
Emergency Exit	10-180-2
Procedure	10-180-1
TOWING THE LOADER	10-50-1
Procedure	10-50-1
TRANSPORTING THE LOADER ON A TRAILER	10-40-1
Fastening	10-40-1
Loading And Unloading	10-40-1
TIGHTEN ALL HARDWARE PER SIZE TO GRADE 5 (SEE STANDARD TORQUE SPECIFICATIONS FOR BOLTS, SPEC-01 SECTION) TORQUE UNLESS OTHERWISE SPECIFIED.	

LIFTING AND BLOCKING THE LOADER

Procedure



Instructions are necessary before operating or servicing machine. Read and understand the Operation & Maintenance Manual, Operator's Handbook and signs (decals) on machine. Follow warnings and instructions in the manuals when making repairs, adjustments or servicing. Check for correct function after adjustments, repairs or service. Untrained operators and failure to follow instructions can cause injury or death.

W-2003-0903

Figure 10-10-1

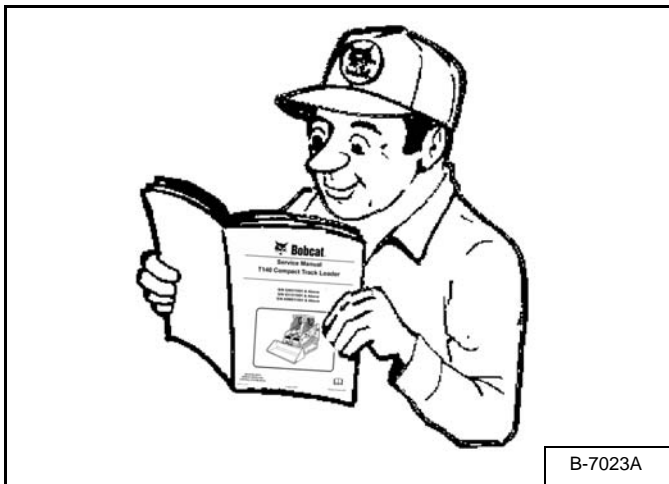

Put jackstands under the front axles and rear corners of the frame before running the engine for service. Failure to use jackstands can allow the machine to fall or move and cause injury or death.

W-2017-0286

Figure 10-10-2



Always park the loader on a level surface.

Put floor jack under the rear of the loader [Figure 10-10-2].

Lift the rear of the loader and install jackstands [Figure 10-10-2].

Figure 10-10-3

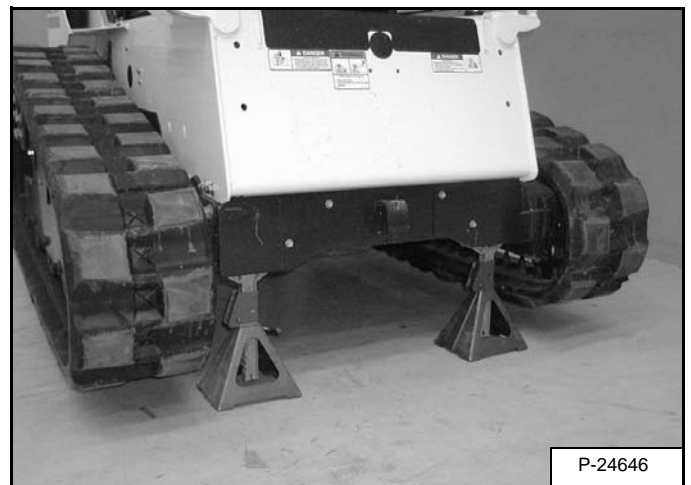

Put the floor jack under the front of the loader [Figure 10-10-3].

Lift the front of the loader and put jackstands under the axle tubes [Figure 10-10-3].

NOTE: Make sure the jackstands do not touch the tracks. Make sure the tracks clear the floor or any obstacles.

LIFT ARM SUPPORT DEVICE

Installing

! WARNING

Never work on a machine with the lift arms up unless the lift arms are secured by an approved lift arm support device. Failure to use an approved lift arm support device can allow the lift arms or attachment to fall and cause injury or death.

Service lift arm support device if damaged or if parts are missing. Using a damaged lift arm support or with missing parts can cause lift arms to drop causing injury or death.

W-2572-0407

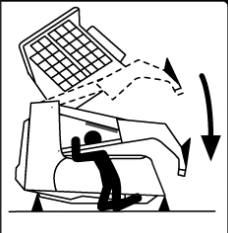
<h2>! DANGER</h2> <p>AVOID DEATH</p> <ul style="list-style-type: none">• Disconnecting or loosening any hydraulic tubeline, hose, fitting, component or a part failure can cause lift arms to drop.• Keep out of this area when lift arms are raised unless supported by an approved lift arm support. Replace if damaged. <p>67116 SW 6717343A enUS</p>	
--	--

Remove the attachment from the loader. (See BOB-TACH (HAND LEVER) on Page 50-40-1.) **OR** (See BOB-TACH (POWER) on Page 50-41-1.)

Figure 10-20-1

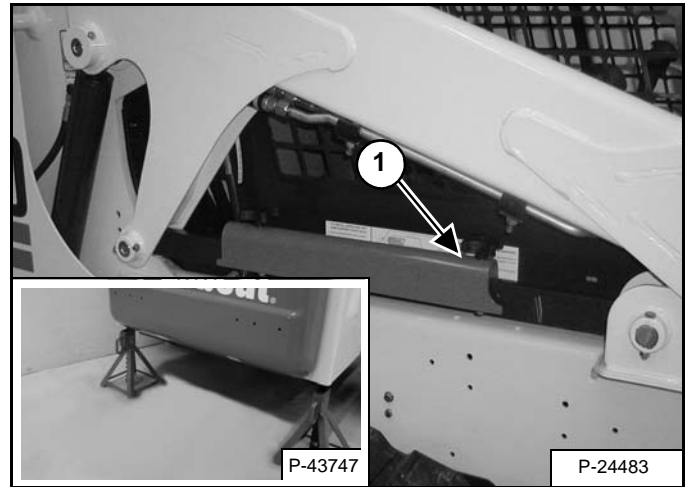

Put jackstands under the rear corners of the loader frame (Inset) [Figure 10-20-1].

Remove the lift arm support device (Item 1) [Figure 10-20-1] from storage position.

The operator must be in the operator's seat, with the seat belt fastened and seat bar lowered, until the lift arm support device is installed.

Start the engine, and raise the lift arms all the way up.

Figure 10-20-2



Have a second person install the lift arm support device over the rod of one of the lift cylinders [Figure 10-20-2].

The lift arm support device must be tight against the cylinder rod.

LIFT ARM SUPPORT DEVICE (CONT'D)

Installing (Cont'd)

Figure 10-20-3

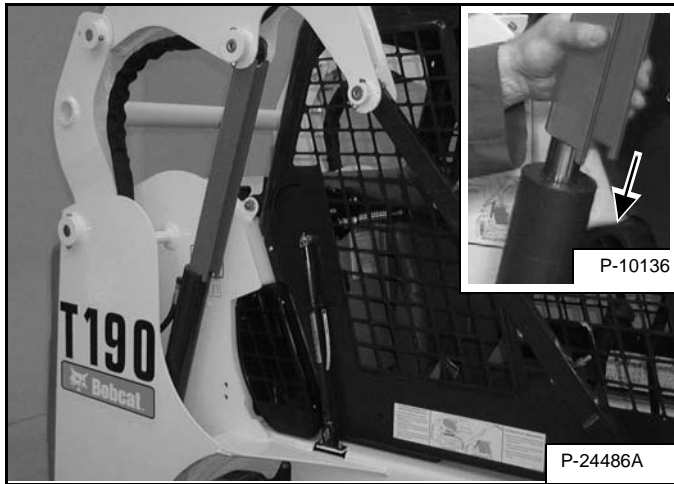

Lower the lift arms slowly until the lift arm support device is held between the lift arms and the lift cylinder **[Figure 10-20-3]**. The tabs of the lift arm support device must go under the cylinder (Inset) **[Figure 10-20-3]**.

Removing

The operator must be in the operator's seat, with the seat belt fastened and seat bar lowered, until the lift arm support device is removed and the lift arms are lowered all the way.

Start the engine, raise the lift arms all the way up.

Have a second person remove the lift arm support device.

Lower the lift arms all the way and stop the engine.

Return the lift arm support device to storage position and secure with clamping knobs.

Remove the jackstands.

OPERATOR CAB

Description

The Bobcat Loader has an operator cab (ROPS and FOPS) as standard equipment to protect the operator from rollover and falling objects. Check with your dealer if the operator cab has been damaged. The seat belt must be worn for rollover protection.

ROPS / FOPS - Roll Over protective Structure per ISO 3471, and Falling Object Protective Structure per SAE J1043 and ISO 3449, Level I. Level II is available.

Level I

Protection from falling bricks, small concrete blocks, and hand tools encountered in operations such as highway maintenance, landscaping, and other construction sites.

Level

Protection from falling trees, rocks: for machines involved in site clearing, overhead demolition or forestry.



Never modify operator cab by welding, grinding, drilling holes or adding attachments unless instructed to do so by Bobcat Company. Changes to the cab can cause loss of operator protection from rollover and falling objects, and result in injury or death.

W-2069-0200

OPERATOR CAB (CONT'D)

Raising

Always stop the engine before raising or lowering the cab.

Stop the loader on a level surface. Lower the lift arms. If the lift arms must be up while raising the operator cab, install the lift arm support device. (See Installing on Page 10-20-1.)

Figure 10-30-1

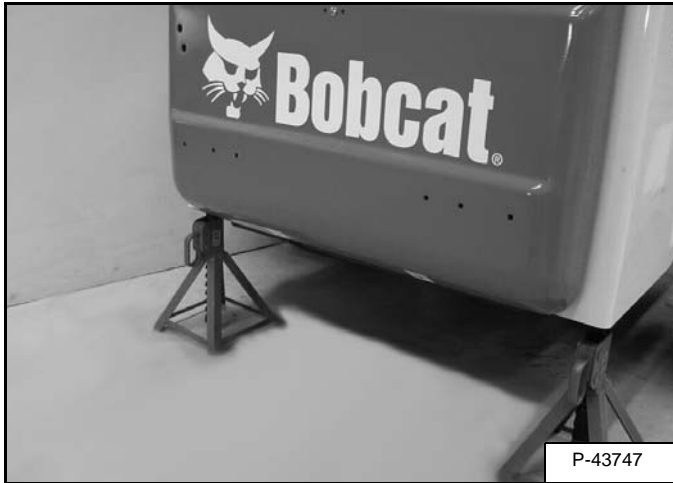

Install jackstands under the rear of the loader frame [Figure 10-30-1].

Figure 10-30-2

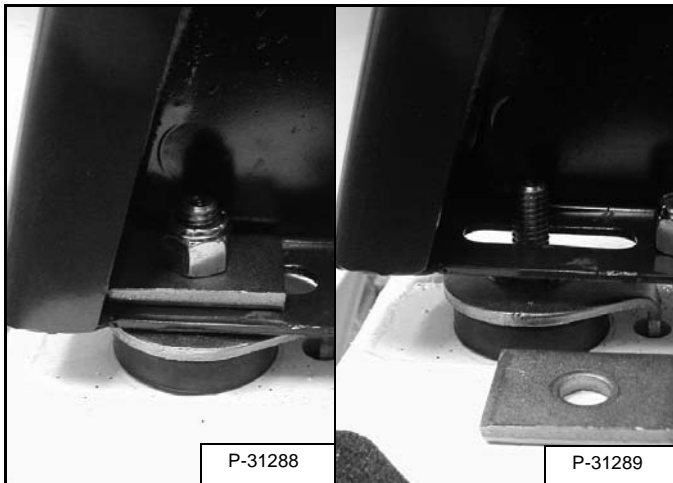

Remove the nuts and plates [Figure 10-30-2] (both sides) at the front corners of the cab.



NOTE: On Advanced Control System (ACS) equipped machines, the steering levers could contact the cab frame while raising or lowering the operator cab. The engine **MUST** be stopped before raising or lowering the cab.

Figure 10-30-3



Lift on the grab handles and bottom of the operator cab [Figure 10-30-3] slowly until the cab is all the way up and the latching mechanism engages.

OPERATOR CAB (CONT'D)

Lowering

Always stop the engine before raising or lowering the cab.

NOTE: Always use the grab handles to lower the cab.

Figure 10-30-4

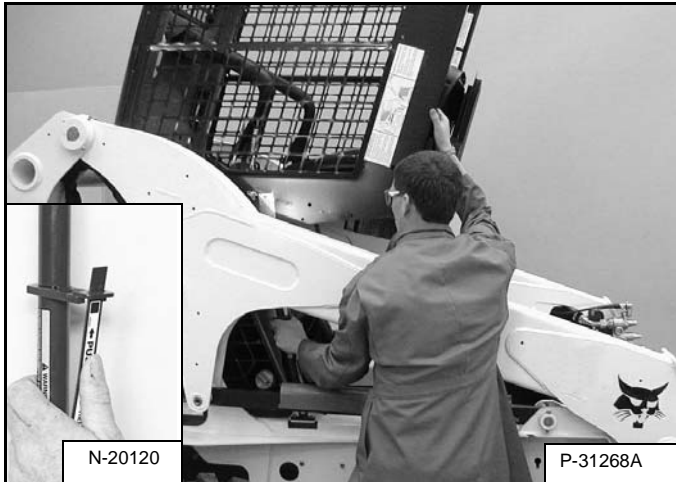

Pull down on the bottom of the operator cab until it stops at the latching mechanism [Figure 10-30-4].

NOTE: The weight of the cab increases when equipped with options and accessories such as cab door, heater, air conditioning, etc. In these cases, the cab may need to be raised slightly from the latch to be able to release the latch.



NOTE: On Advanced Control System (ACS) equipped machines, the steering levers could contact the cab frame while raising or lowering the operator cab. The engine **MUST** be stopped before raising or lowering the cab.

Support the cab and release the latching mechanism (Inset) [Figure 10-30-4]. Remove your hand from latching mechanism when the cab is past the latch stop. Use both hands to lower the cab all the way down.

! WARNING

PINCH POINT CAN CAUSE INJURY

Remove your hand from the latching mechanism when the cab is past the latch stop.

W-2469-0803

Figure 10-30-5

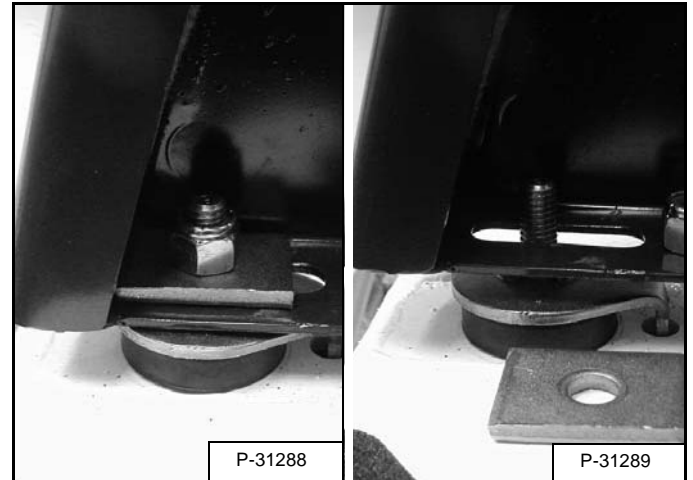

Install the plates and nuts [Figure 10-30-5] (both sides).

Tighten the nuts to 40-45 ft.-lb. (54-61 N•m) torque.

OPERATOR CAB (CONT'D)

Cab Door Sensor

This machine may be equipped with a Cab Door Sensor.

Figure 10-30-6

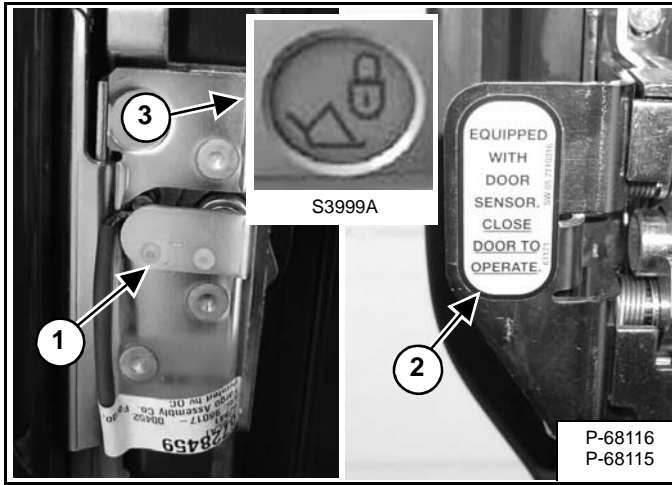

The cab door has a sensor (Item 1) [Figure 10-30-6] installed which deactivates the lift and tilt valves when the door is open.

A decal is located on the latch mechanism (Item 2) [Figure 10-30-6].

The LIFT & TILT VALVE light (Item 3) [Figure 10-30-6] will be OFF when the door is closed, the key switch is turned to RUN or the RUN / ENTER button is pressed, the seat bar is lowered and the PRESS TO OPERATE LOADER button is pressed.

Figure 10-30-7



The LIFT & TILT VALVE light (Item 3) [Figure 10-30-6] will be ON when the door is open, the key switch is turned to RUN or the RUN / ENTER button is pressed, the seat bar is lowered and the PRESS TO OPERATE LOADER button is pressed.

[DOOR] will appear in the data display [Figure 10-30-7].

Special Applications Kit

! WARNING

AVOID INJURY OR DEATH

Some attachment applications can cause flying debris or objects to enter front, top or rear cab openings. Install the Special Applications Kit to provide added operator protection in these applications.

W-2737-0508

Figure 10-30-8

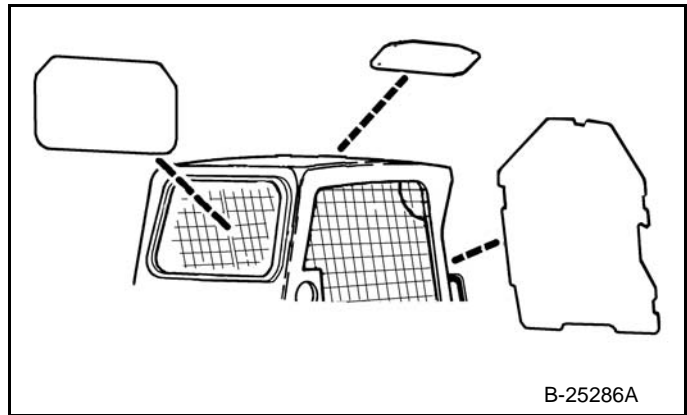

Available for special applications to restrict material from entering cab openings. Kit includes 1/2 inch Lexan® front door, top and rear windows [Figure 10-30-8].

See your Bobcat dealer for availability.

Special Applications Kit Inspection And Maintenance

- Inspect for cracks or damage. Replace if required.
- Pre-rinse with water to remove gritty materials.
- Wash with a mild household detergent and warm water.
- Use a sponge or soft cloth. Rinse well with water and dry with a clean soft cloth or rubber squeegee.
- Do not use abrasive or highly alkaline cleaners.
- Do not operate windshield wipers on a dry surface.
- Do not clean with metal blades or scrapers.

TRANSPORTING THE LOADER ON A TRAILER

Loading And Unloading



AVOID SERIOUS INJURY OR DEATH

Adequately designed ramps of sufficient strength are needed to support the weight of the machine when loading onto a transport vehicle. Wood ramps can break and cause personal injury.

W-2058-0807

Be sure the transport and towing vehicles are of adequate size and capacity for weight of loader. (See Performance on Page SPEC-10-2.)

Figure 10-40-1

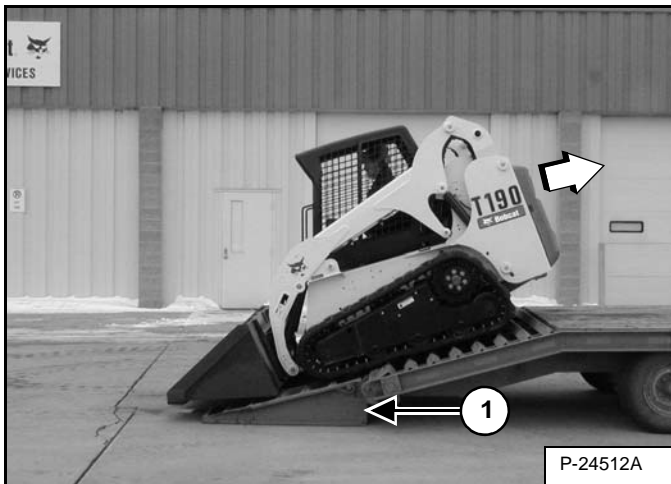

A loader with an empty bucket or no attachment must be loaded backward onto the transport vehicle [Figure 10-40-1].

The rear of the trailer must be blocked or supported (Item 1) [Figure 10-40-1] when loading or unloading the loader to prevent the front end of the trailer from raising up.

Fastening

Figure 10-40-2

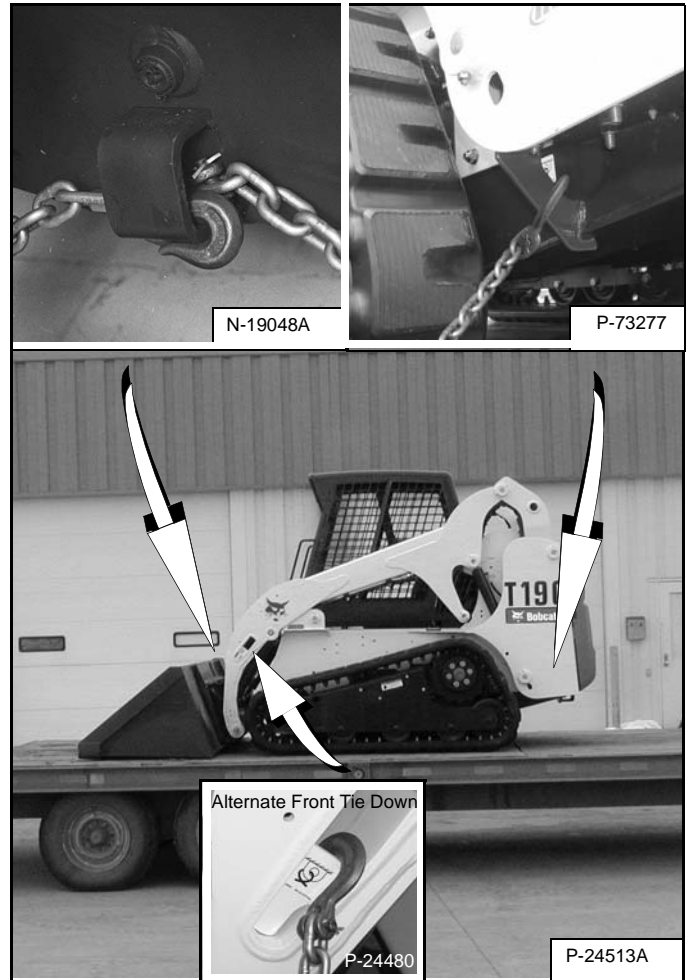

Use the following procedure to fasten the Bobcat Loader to the transport vehicle to prevent the loader from moving during sudden stops or when going up or down slopes [Figure 10-40-2].

- Lower the bucket or attachment to the floor.
- Stop the engine.
- Engage the parking brake.
- Install chains at the front and rear loader tie down positions [Figure 10-40-2].
- Fasten each end of the chain to the transport vehicle.

TOWING THE LOADER

Procedure

Because of the design of the loader, there is not a recommended towing procedure.

- The loader can be lifted onto a transport vehicle.
- The loader can be skidded a short distance to move for service (EXAMPLE: Move onto a transport vehicle.) without damage to the hydrostatic system. (The tracks will not turn.) There might be slight wear to the tracks when the loader is skidded.

The towing chain (or cable) must be rated at one and one-half times the weight of the loader. (See Performance on Page SPEC-10-2.)

REMOTE START TOOL KIT-MEL1563

Remote Start Tool - MEL1563

Tools that will be needed to complete the following steps are:

MEL1563 - Remote Start Tool

MEL1565 - Service Tool Harness Control

MEL1566 - Service Tool Harness Communicator (Computer Interface)

Figure 10-60-1

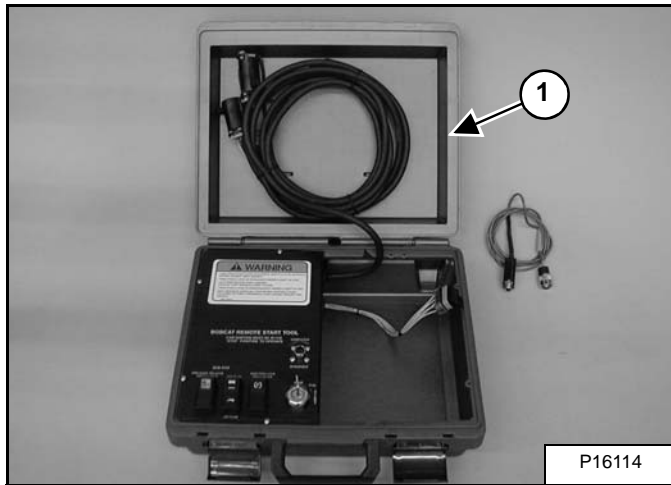

The remote start tool (Item 1) [Figure 10-60-1] is required when the service technician is checking the hydraulic/hydrostatic system or adjusting the steering linkage.

Figure 10-60-2

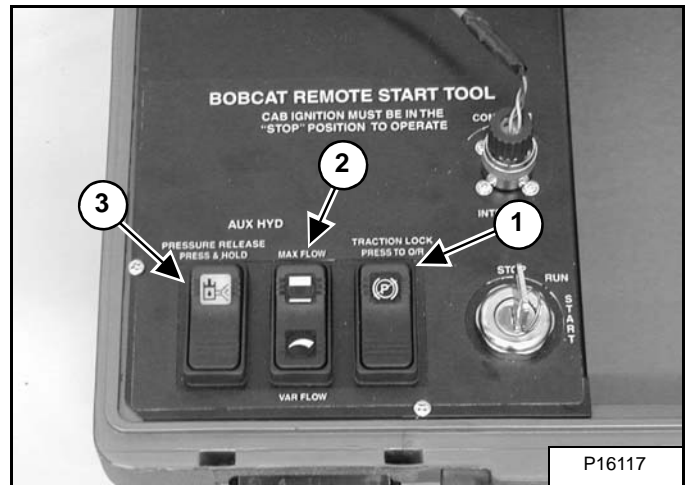

The traction lock switch (Item 1) [Figure 10-60-2] is used to turn traction lock ON or OFF. Push the switch to the override position. The switch will illuminate to indicate traction lock OVERRIDE, in this position the wheels are able to turn.

The maximum flow/variable flow switch (Item 2) [Figure 10-60-2] is used to activate the auxiliary hydraulics. Pressing the switch once will activate maximum flow. Pressing the switch again will activate variable flow. The switch will illuminate to indicate which flow rate is active. Pressing the switch a third time will turn the flow OFF. The switch is used when checking pressures and flow rate.

The auxiliary pressure release (Item 3) [Figure 10-60-2] is used to release hydraulic pressure to the front and/or rear auxiliary couplers. To release pressure; push and hold the switch for a few seconds.

NOTE: With the engine running; pushing and holding the pressure release switch will cause the engine to stop. To relieve the pressure; press the switch until the engine stops.

REMOTE START TOOL-MEL1563 (CONT'D)

Remote Start Tool - MEL1563 (Cont'd)

Figure 10-60-3

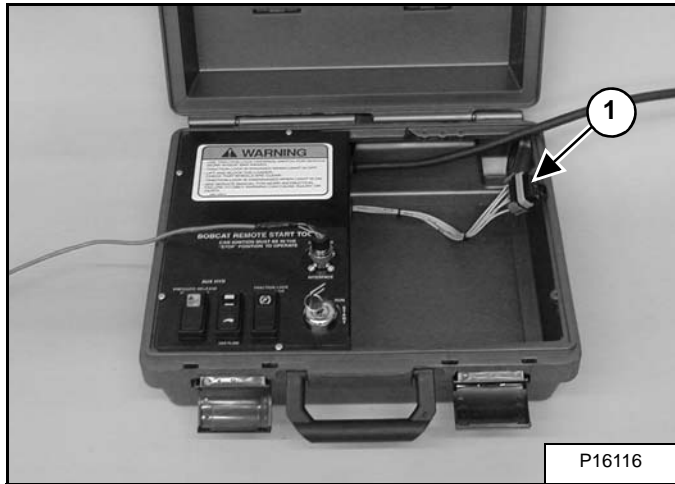

Figure 10-60-4



The 10-pin rectangular connector (Item 1) [Figure 10-60-3] is used to update software in the Deluxe Instrumentation Panel (Item 1) [Figure 10-60-4].

NOTE: The Service PC must be connected to the remote start tool to update the deluxe panel software.

The panel must be removed from inside the operator cab and plugged into this connector [Figure 10-60-3].

Service Tool Harness Control - MEL1565

Figure 10-60-5

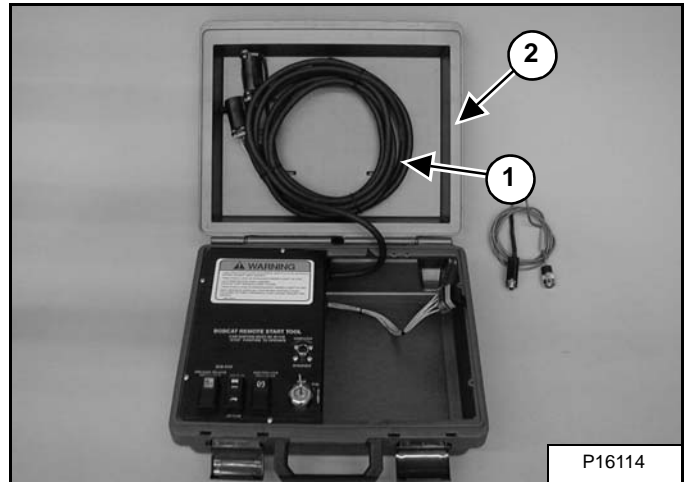

The service tool harness control (Item 1) [Figure 10-60-5] is used to connect the remote start tool (Item 2) [Figure 10-60-5] to the electrical system on the loader.

Figure 10-60-6

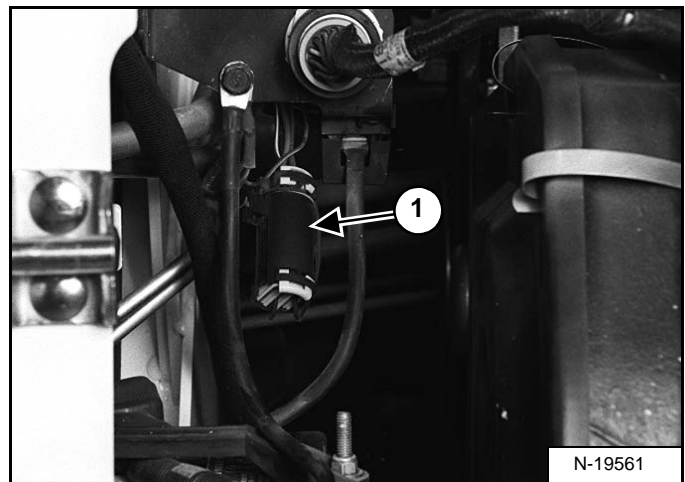

Remove the plug (Item 1) [Figure 10-60-6] from the loader harness connector.

Connect the service tool harness control to the loader harness connector.



Suggest:

If the above button click is invalid.

Please download this document first, and then click the above link to download the complete manual.

Thank you so much for reading

REMOTE START TOOL-MEL1563 (CONT'D)

Service Tool Harness Control - MEL1565 (Cont'd)

Figure 10-60-7

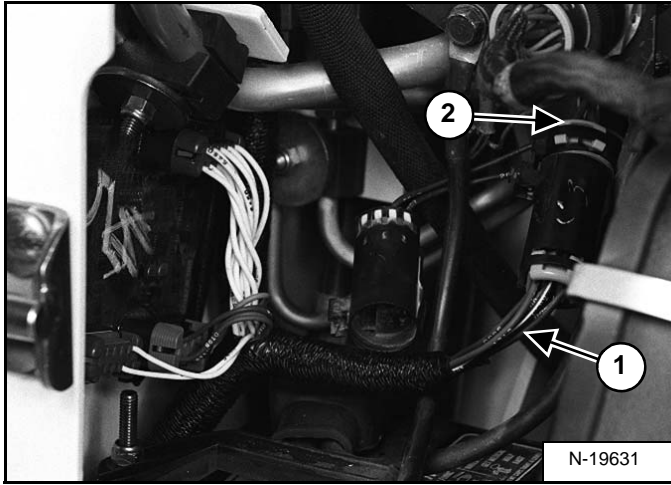

Loaders equipped with an attachment harness (Item 1) [Figure 10-60-7] must disconnect the attachment harness from the loader harness (Item 2) [Figure 10-60-7].

Connect the service tool harness to the ACD connector and the loader harness connector.

NOTE: To monitor, diagnose or load new software the Service PC must be connected to the Remote Start Tool Switch.

Service Tool Harness Communicator - MEL1566

Figure 10-60-8

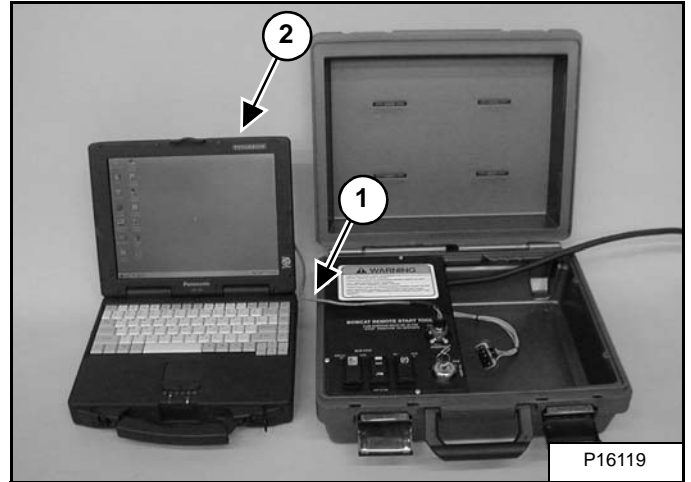

The service tool harness communicator (Item 1) [Figure 10-60-8] is required to connect remote start tool to the Service PC (Item 2) [Figure 10-60-8].

<https://www.ebooklibonline.com>

Hello dear friend!

Thank you very much for reading.

Enter the link into your browser.

The full manual is available for immediate download.

<https://www.ebooklibonline.com>