

T190

TURBO

T190

TURBO

HIGH FLOW



Bobcat®

Service Manual

G Series

(S/N 519311001 & Above)

(S/N 519411001 & Above)

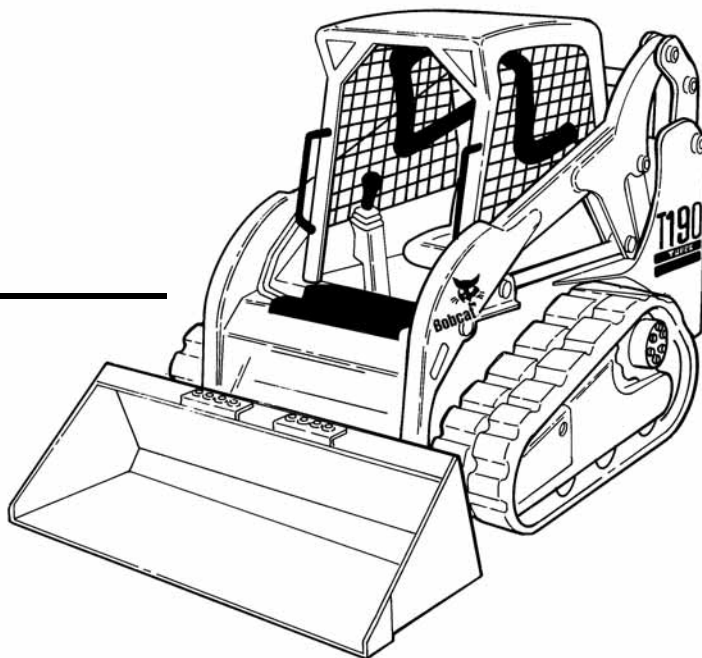

EQUIPPED WITH
BOBCAT INTERLOCK
CONTROL SYSTEM (BICS™)

MAINTENANCE SAFETY



WARNING

Instructions are necessary before operating or servicing machine. Read and understand the Operation & Maintenance Manual, Operator's Handbook and signs (decals) on machine. Follow warnings and instructions in the manuals when making repairs, adjustments or servicing. Check for correct function after adjustments, repairs or service. Untrained operators and failure to follow instructions can cause injury or death.

W-2003-0903



Safety Alert Symbol: This symbol with a warning statement, means: "Warning, be alert! Your safety is involved!" Carefully read the message that follows.

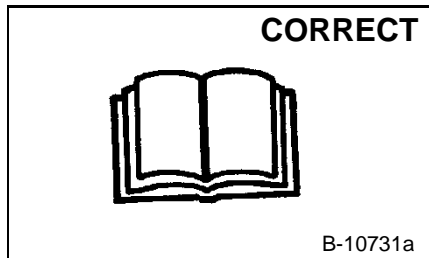

Never service the Bobcat Compact Track Loader without instructions.

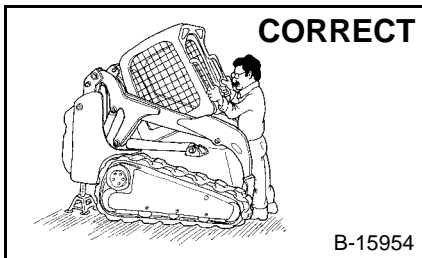

Use the correct procedure to lift or lower operator cab.

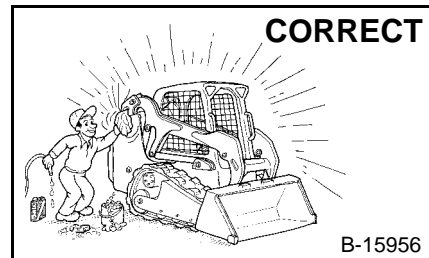

Cleaning and maintenance are required daily.

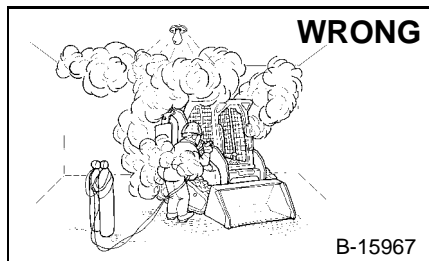

- Have good ventilation when welding or grinding painted parts.
- Wear dust mask when grinding painted parts. Toxic dust and gas can be produced.
- Avoid exhaust fume leaks which can kill without warning. Exhaust system must be tightly sealed.

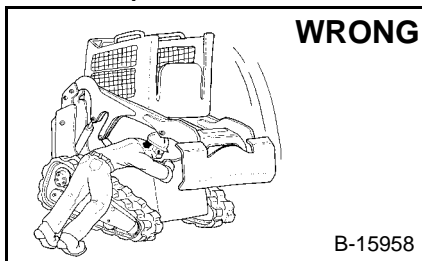

Disconnecting or loosening any hydraulic tubeline, hose, fitting, component or a part failure can cause lift arms to drop. Do not go under lift arms when raised unless supported by an approved lift arm support device. Replace it if damaged.

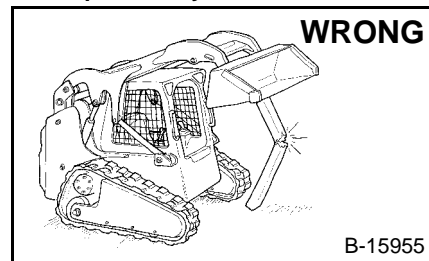

- Never work on loader with lift arms up unless lift arms are held by an approved lift arm support device. Replace if damaged.
- Never modify equipment or add attachments not approved by Bobcat Company.

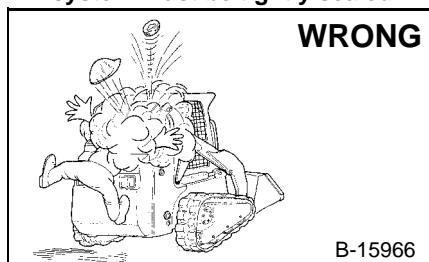

- Stop, cool and clean engine of flammable materials before checking fluids.
- Never service or adjust loader with the engine running unless instructed to do so in the manual.
- Avoid contact with leaking hydraulic fluid or diesel fuel under pressure. It can penetrate the skin or eyes.
- Never fill fuel tank with engine running, while smoking or when near open flame.

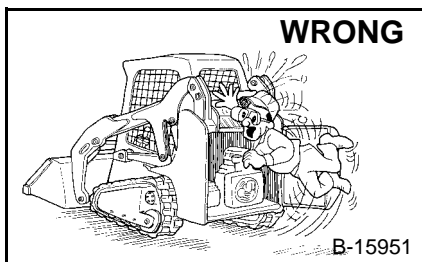

- Keep body, jewelry and clothing away from moving parts, electrical contact, hot parts and exhaust.
- Wear eye protection to guard from battery acid, compressed springs, fluids under pressure and flying debris when engines are running or tools are used. Use eye protection approved for type of welding.
- Keep rear door closed except for service. Close and latch door before operating the loader.

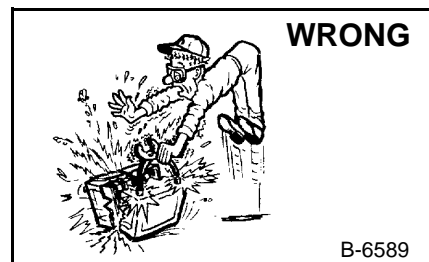

- Lead-acid batteries produce flammable and explosive gases.
- Keep arcs, sparks, flames and lighted tobacco away from batteries.
- Batteries contain acid which burns eyes or skin on contact. Wear protective clothing. If acid contacts body, flush well with water. For eye contact flush well and get immediate medical attention.

Maintenance procedures which are given in the Operation & Maintenance Manual can be performed by the owner/operator without any specific technical training. Maintenance procedures which are **not** in the Operation & Maintenance Manual must be performed **ONLY BY QUALIFIED BOBCAT SERVICE PERSONNEL**. Always use **genuine Bobcat replacement parts**. The Service Safety Training Course is available from your Bobcat dealer.

ALPHABETICAL INDEX

ADVANCED CONTROL SYSTEM (ACS)	60-01	FAN GEARBOX	10-01
ADVANCED CONTROL SYSTEM (ACS)	60-01	FLYWHEEL AND HOUSING	70-01
AIR CLEANER	70-01	FRONT AUXILIARY HYD. COUPLER BLOCK	20-01
AIR CLEANER SERVICE	10-01	FRONT AUXILIARY PRESSURE RELIEF BLOCK	20-01
AIR CONDITIONING SERVICE	80-01	FUEL SYSTEM	10-01
AIR CONDITIONING SYSTEM FLOW	80-01	FUEL TANK	50-01
ALTERNATOR (90 AMP)	60-01		
		GENERAL AIR CONDITIONING SERVICE	
BASIC TROUBLESHOOTING	80-01	GUIDELINES	80-01
BATTERY	60-01		
BICS™ SYSTEM	60-01	HEATER COIL	80-01
BOB-TACH	10-01,50-01	HEATER VALVE	80-01
BOBCAT CONTROLLER	60-01	HEATER/AC FAN	80-01
BRAKE	40-01	HYDRAULIC CONNECTION	
BUCKET POSITION VALVE	20-01	SPECIFICATIONS	SPEC-01
		HYDRAULIC CONTROL VALVE (ACS)	20-01
CHARGE PRESSURE	30-01	HYDRAULIC CONTROL VALVE (FOOT)	20-01
COMPONENTS	80-01	HYDRAULIC FILTER HOUSING	20-01
COMPRESSOR	80-01	HYDRAULIC FLUID RESERVOIR	20-01
CONDENSER	80-01	HYDRAULIC PUMP	20-01
CONTROL HANDLE	80-01	HYDRAULIC PUMP (HI FLOW)	20-01
CONTROL HANDLE (ADVANCED CONTROL		HYDRAULIC SYSTEM INFORMATION	20-01
SYSTEM) (ACS) SELECTABLE HAND/FOOT		HYDRAULIC/HYDROSTATIC FLUID	
CONTROL	50-01	SPECIFICATIONS	SPEC-01
CONTROL HANDLE (ADVANCED CONTROL		HYDRAULIC/HYDROSTATIC SYSTEM	10-01
SYSTEM) (ACS) ADVANCED HAND CONTROL	50-01	HYDROSTATIC MOTOR	30-01
CONTROL PANEL	50-01	HYDROSTATIC PUMP	30-01
CONTROL PEDALS	50-01	HYDROSTATIC SYSTEM INFORMATION	30-01
CONTROL PEDALS (ACS)	50-01		
CONVERSIONS	SPEC-01	INSTRUMENT PANEL	60-01
COOLING FAN	70-01		
CYLINDER (LIFT)	20-01	LIFT ARM	50-01
CYLINDER (POWER BOB-TACH)	20-01	LIFT ARM BY-PASS CONTROL VALVE	20-01
CYLINDER (TILT)	20-01	LIFT ARM SUPPORT DEVICE	10-01
		LIFTING AND BLOCKING THE LOADER	10-01
DIAGNOSTICS	60-01	LIGHTS	60-01
DRIVE BELT	30-01	LOADER SPECIFICATIONS	SPEC-01
DRIVE COMPONENTS	40-01	LUBRICATION OF THE BOBCAT LOADER	10-01
ELECTRICAL SYSTEM INFORMATION	60-01	MAIN RELIEF VALVE	20-01
ELECTRICAL/HYDRAULIC CONTROLS		MUFFLER	70-01
REFERENCE	60-01		
ENGINE	70-01	OIL COOLER	30-01
ENGINE COMPONENTS AND TESTING	70-01	OPERATOR CAB	10-01,50-01
ENGINE COOLING SYSTEM	10-01	OPERATOR SEAT	50-01
ENGINE LUBRICATION SYSTEM	10-01	OPERATOR SEAT (SUSPENSION)	50-01
ENGINE SPECIFICATIONS-			
KUBOTA V2003T-EB (TURBO)	SPEC-01	POWER BOB-TACH	50-01
ENGINE SPEED CONTROL	70-01	POWER BOB-TACH (OPTION)	10-01
EVAPORATOR	80-01	POWER BOB-TACH BLOCK	20-01
EVAPORATOR/HEATER UNIT	80-01	PRESSURE RELIEF VALVE	80-01
EXPANSION VALVE	80-01	PRESSURE SWITCH	80-01

ALPHABETICAL INDEX

RPM SENSOR.....	60-01
RADIATOR.....	70-01
REAR AUXILIARY DIVERTER VALVE (DUAL SHUTTLE)	20-01
REAR DOOR	50-01
REAR GRILL	50-01
RECEIVER/DRIER	80-01
RECONDITIONING THE ENGINE	70-01
REGULAR MAINTENANCE	80-01
REMOTE START	10-01
SAFETY	80-01
SEAT BAR	50-01
SEAT BAR SENSOR	60-01
SELECT VALVE.....	20-01
SERVICE SCHEDULE	10-01
SPARK ARRESTOR MUFFLER	10-01
STARTER	60-01
SYSTEM CHARGING AND RECLAMATION	80-01
SYSTEM TROUBLESHOOTING CHART	80-01
TEMPERATURE/PRESSURE	80-01
THERMOSTAT.....	80-01
TORQUE SPECIFICATIONS FOR BOLTS.....	SPEC-01
TOWING THE LOADER	10-01
TRACTION LOCK.....	60-01
TRANSPORTING THE BOBCAT LOADER.....	10-01
TROUBLESHOOTING.....	70-01
TURBOCHARGER	70-01

ACS-ADVANCED CONTROL SYSTEM
AHC-ADVANCED HAND CONTROL SYSTEM
BICS-BOBCAT INTERLOCK CONTROL SYSTEM

<https://www.ebooklibonline.com>

Hello dear friend!

Thank you very much for reading.

Enter the link into your browser.

The full manual is available for immediate download.

<https://www.ebooklibonline.com>

CONTENTS

FOREWORD.....	II
SAFETY INSTRUCTIONS	V
SERIAL NUMBER LOCATION	IX
DELIVERY REPORT.....	IX
BOBCAT LOADER IDENTIFICATION.....	X
SAFETY & MAINTENANCE	10-01
HYDRAULIC SYSTEM	20-01
HYDROSTATIC SYSTEM.....	30-01
DRIVE SYSTEM	40-01
MAIN FRAME	50-01
ELECTRICAL SYSTEM	60-01
ENGINE SERVICE	70-01
HEATING, VENTILATION, AIR CONDITIONING	80-01
SPECIFICATIONS.....	SPEC-01

**SAFETY &
MAINTENANCE**

**HYDRAULIC
SYSTEM**

**HYDROSTATIC
SYSTEM**

**DRIVE
SYSTEM**

MAIN FRAME

**ELECTRICAL
SYSTEM &
ANALYSIS**

**ENGINE
SERVICE**

HVAC

SPECIFICATIONS

FOREWORD

This manual is for the Bobcat loader mechanic. It provides necessary servicing and adjustment procedures for the Bobcat loader and its component parts and systems. Refer to the Operation & Maintenance Manual for operating instructions, Starting procedure, daily checks, etc.

A general inspection of the following items must be made after the loader has had service or repair:

1. Check lift arm support device, replace if damaged. (Stored Position)

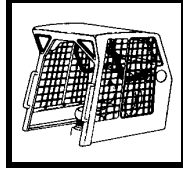

2. Check that ROPS mounting hardware is tightened and is Bobcat approved.



3. The seat belt must be correctly installed, functional and in good condition.

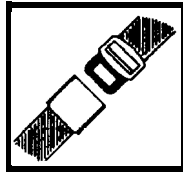

4. The seat bar must be correctly adjusted, clean and lubricated.

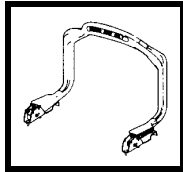

5. Check lift arm support device, replace if damaged.

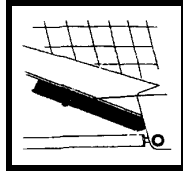

6. Machine signs must be legible and in the correct location.



7. Steering levers and foot pedals must return to neutral.

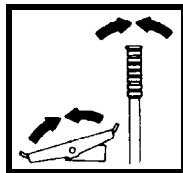

8. Check for correct function of the work lights.



9. The parking brake must function correctly.



10. Enclosure door latches must open and close freely.

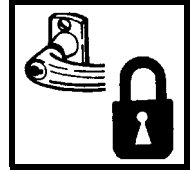

11. Bob-Tach wedges and linkages must function correctly and be in good condition.

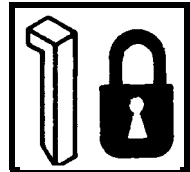

12. Safety treads must be in good condition.

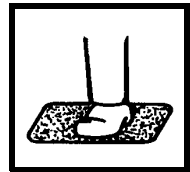

13. Check for correct function of indicator lamps (Optional on some models.)

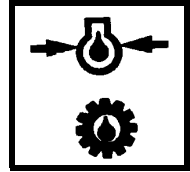

14. Check hydraulic fluid level, engine oil level and fuel supply.

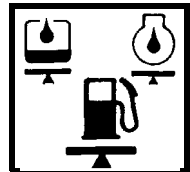

15. Inspect for fuel, oil or hydraulic fluid leaks.

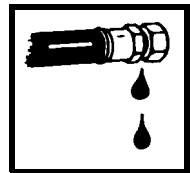

16. Lubricate the loader.

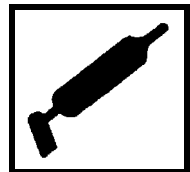

17. Check the condition of the battery and cables.



22. Operate the loader and check all functions.

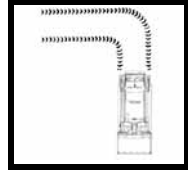

18. Inspect the air cleaner for damage or leaks. Check the condition of the element.

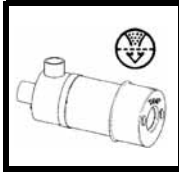

23. Check for any field modification not completed.



19. Check the electrical charging system.

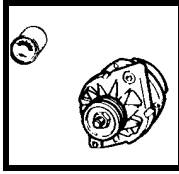

24. Check for correct function of the Bobcat Interlock Control System (BICST™) before the machine is returned to the customer.

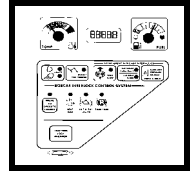

20. Check tracks for wear.

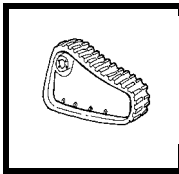

Recommend to the owner that all necessary corrections be made before the machine is returned to service.

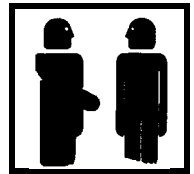

21. Inspect for loosen or broken parts or connections.

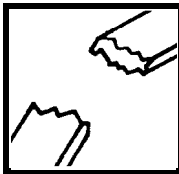

**CALIFORNIA
PROPOSITION 65 WARNING**

Diesel engine exhaust and some of its constituents are known to the State of California to cause cancer, birth defects and other reproductive harm.

SAFETY INSTRUCTIONS



Safety Alert Symbol

This symbol with a warning statement means:
“Warning, be alert! Your safety is involved!”
Carefully read the message that follows.



WARNING

Instructions are necessary before operating or servicing machine. Read and understand the Operation & Maintenance Manual, Operator's Handbook and signs (decals) on machine. Follow warnings and instructions in the manuals when making repairs, adjustments or servicing. Check for correct function after adjustments, repairs or service. Untrained operators and failure to follow instructions can cause injury or death.

W-2003-0903



WARNING

Warnings on the machine and in the manuals are for your safety. Failure to obey warnings can cause injury or death.

W-2044-1285

IMPORTANT

This notice identifies procedures which must be followed to avoid damage to the machine.

I-2019-0284

The following publications provide information on the safe use and maintenance of the Bobcat machine and attachments:

- The Delivery Report is used to assure that complete instructions have been given to the new owner and that the machine is in safe operating condition.
- The Operation & Maintenance Manual delivered with the machine or attachment contains operating information as well as routine maintenance and service procedures. It is a part of the machine and can be stored in a container provided on the machine. Replacement Operation & Maintenance Manuals can be ordered from your Bobcat dealer.
- Machine signs (decals) instruct on the safe operation and care of your Bobcat machine or attachment. The signs and their locations are shown in the Operation & Maintenance Manual. Replacement signs are available from your Bobcat dealer.
- An Operator's Handbook fastened to the operator cab. It's brief instructions are convenient to the operator. The handbook is available from your dealer in an English edition or one of many other languages. See your Bobcat dealer for more information on translated versions.
- The AEM Safety Manual delivered with the machine gives general safety information.
- The Service Manual and Parts Manual are available from your dealer for use by mechanics to do shop-type service and repair work.
- The Skid-Steer Loader Operator Training Course is available through your local dealer or at www.training.bobcat.com or www.bobcat.com. This course is intended to provide rules and practices of correct operation of the Skid-Steer Loader. The course is available in English and Spanish versions.
- Service Safety Training Courses are available from your Bobcat dealer or at www.training.bobcat.com or www.bobcat.com. They provide information for safe and correct service procedures.
- The Skid-Steer Loader Safety Video is available from your Bobcat dealer or at www.training.bobcat.com or www.bobcat.com.

SI SSL-0206 SM

SAFETY INSTRUCTIONS (CONT'D)

Fire Prevention

The machine and attachments have components that are at high temperature under normal operating conditions. The primary source of high temperatures is the engine and exhaust system. The electrical system, if damaged or incorrectly maintained, can be a source of arcs or sparks.

Flammable debris (leaves, straw, etc.) must be removed regularly. If flammable debris is allowed to accumulate, it will increase fire hazard. Clean often to avoid this accumulation. Flammable debris in the engine compartment is a potential hazard.

The spark arrestor muffler is designed to control the emission of hot particles from the engine and exhaust system, but the muffler and the exhaust gases are still hot.

- Do not use the machine where exhaust, arcs, sparks or hot components can contact flammable material, explosive dust or gases.
- The operator cab, engine compartment, and engine cooling system must be inspected every day and cleaned if necessary to prevent fire hazard and overheating.
- Check all electrical wiring and connections for damage. Keep the battery terminals clean and tight. Repair or replace any damaged part.
- Check fuel and hydraulic tubes, hoses and fittings for damage and leakage. Never use open flame or bare skin to check for leaks. Tighten or replace any parts that show leakage. Always clean fluid spills. Do not use gasoline or diesel fuel for cleaning parts. Use commercial nonflammable solvents.
- Do not use ether or starting fluids on any engine which has glow plugs. These starting aids can cause explosion and injure you or bystanders.
- Always clean the machine, disconnect the battery, and disconnect the wiring from the controllers before welding. Cover rubber hoses, battery and all other flammable parts. Keep a fire extinguisher near the machine when welding. Have good ventilation when grinding or welding painted parts. Wear a dust mask when grinding painted parts. Toxic dust or gas can be produced.
- Stop the engine and let it cool before adding fuel. **NO SMOKING!**

- Use the procedure in the Operation & Maintenance Manual for connecting the battery and for jump starting.
- Use the procedure in the Operation & Maintenance Manual for cleaning the spark arrestor muffler (if equipped).

Figure 1

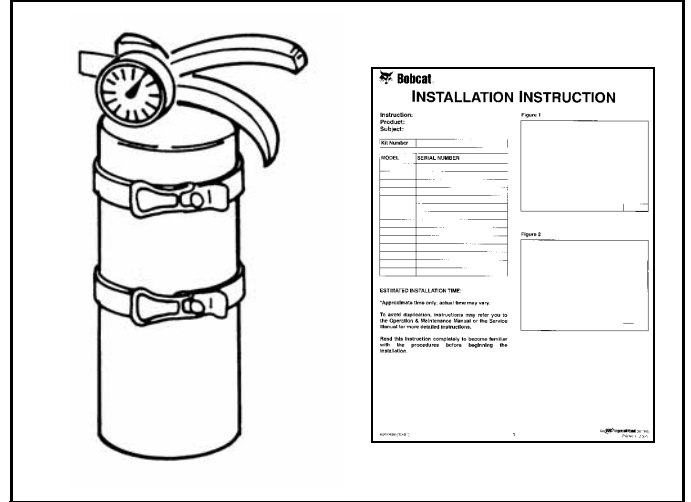

- Know where fire extinguishers and first aid kits are located and how to use them. Fire extinguishers are available from your Bobcat dealer [Figure 1].

SERIAL NUMBER LOCATION

Always use the serial number of the loader when requesting service information or when ordering parts. Early or later models (identification made by serial number) may use different parts, or it may be necessary to use a different procedure in doing a specific service operation.

Loader Serial Number

Figure 2

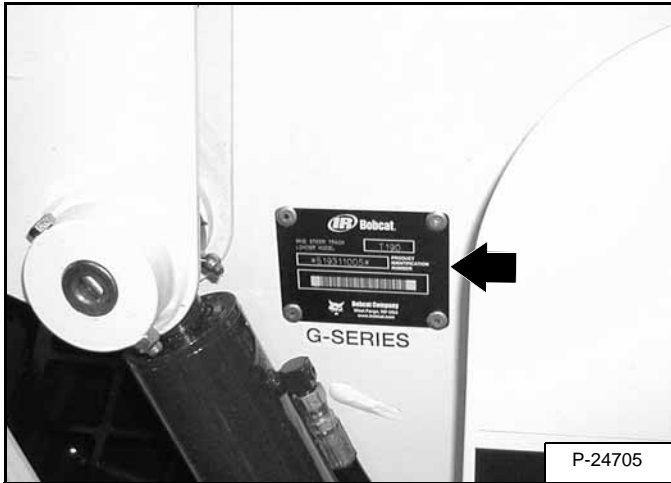

The loader serial number plate is located on the outside of the loader frame [Figure 2].

Explanation of loader Serial Number:

XXXX	XXXXX
Model 1.-Model/ Engine Combination	Model 2.-Production Sequence (Series)

1. The four digit Model/Engine Combination Module number identifies the model number and engine combination.
2. The five digit Production Sequence Number identifies the order which the loader is produced.

Engine Serial Number

Figure 3

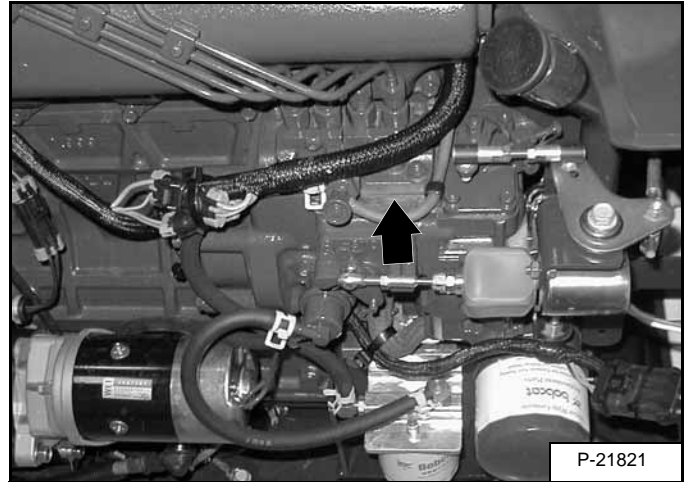

The engine serial number is in the location shown [Figure 3].

DELIVERY REPORT

Figure 4

The Delivery Report must be filled out by the dealer and signed by the owner or operator when the Bobcat loader is delivered. An explanation of the form must be given to the owner. Make sure it is filled out completely [Figure 4].

BOBCAT LOADER IDENTIFICATION

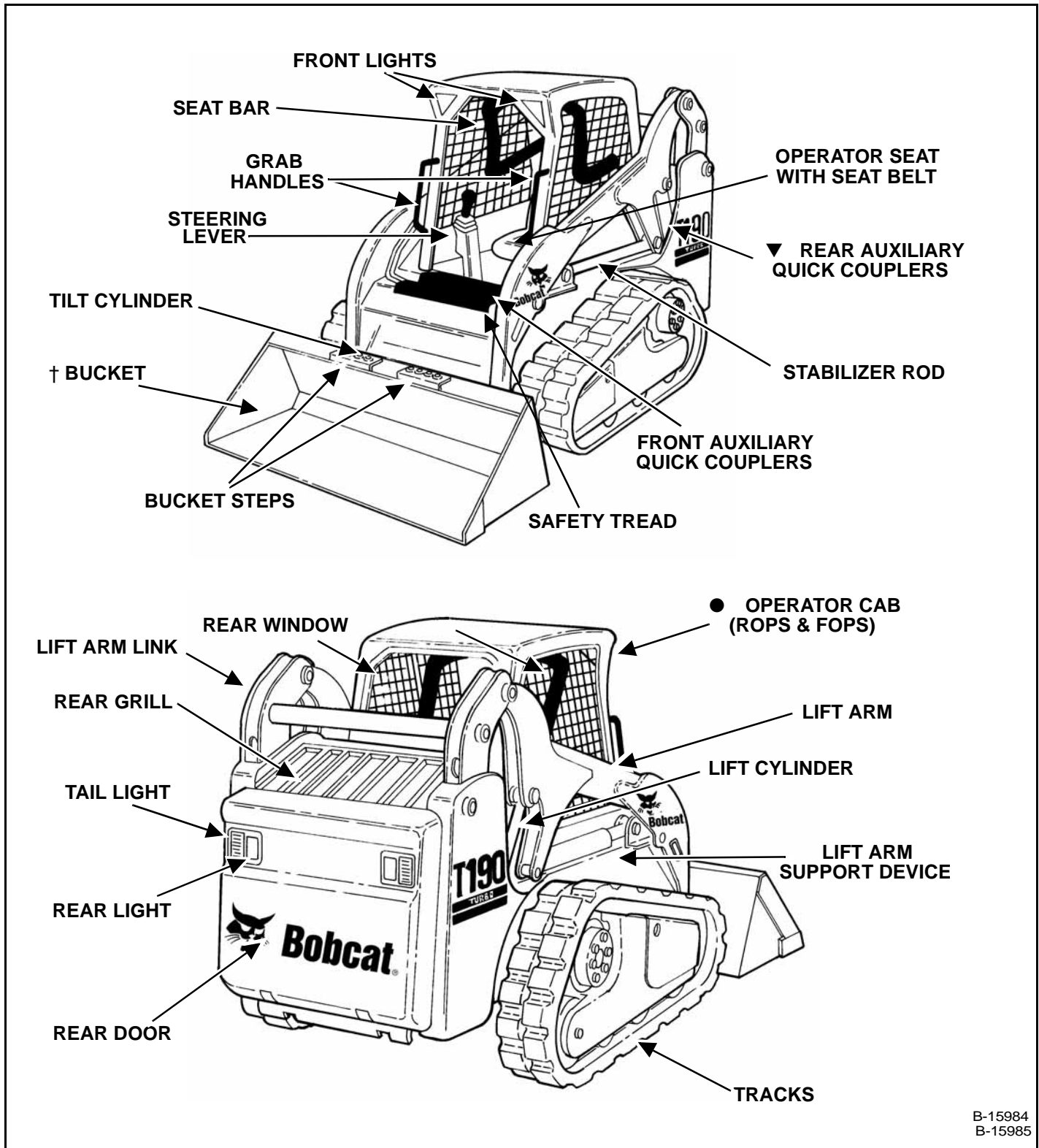

B-15984
B-15985

▼ OPTIONAL OR FIELD ACCESSORY (Not Standard Equipment)

+ BUCKET - Several different buckets and other attachments are available from the Bobcat loader.

● ROPS, FOPS - Roll Over Protective Structure, per SAE J1040 and ISO 3471, and Falling Object Protective Structure per SAEJ1043 and ISO 3449, Level I. Level II is available. The Bobcat loader is base-equipped with a standard operator cab as shown. Extra insulated cab is available as an option (Reduced noise level).

SAFETY & MAINTENANCE

AIR CLEANER SERVICE 10-80-1
 Replacing Filter Element 10-80-1

BOB-TACH 10-140-1
 Inspection And Maintenance 10-140-1

ENGINE COOLING SYSTEM 10-90-1
 Cleaning The Cooling System 10-90-1
 Checking The Coolant Level 10-90-2
 Replacing the Coolant 10-90-2

ENGINE LUBRICATION SYSTEM 10-110-1
 Checking Engine Oil 10-110-1
 Oil Chart 10-110-1
 Replacing Oil And Filter 10-110-1

FAN GEARBOX 10-130-1
 Checking And Maintaining 10-130-1

FUEL SYSTEM 10-100-1
 Filling The Fuel Tank 10-100-1
 Fuel Filter 10-100-2
 Fuel Specifications 10-100-1
 Removing Air From The Fuel System 10-100-2

HYDRAULIC/HYDROSTATIC SYSTEM 10-120-1
 Breather Cap 10-120-3
 Checking And Adding Fluid 10-120-1
 Replacing Hydraulic Fluid 10-120-2
 Replacing Hydraulic/Hydrostatic Filter 10-120-1

LIFT ARM SUPPORT DEVICE 10-20-1
 Installing Lift Arm Support Device 10-20-1
 Removing Lift Arm Support Device 10-20-2

LIFTING AND BLOCKING THE LOADER 10-10-1
 Procedure 10-10-1
 Single Point Lift 10-10-2

LUBRICATION OF THE BOBCAT LOADER 10-150-1
 Procedure 10-150-1

Continued On Next Page

SAFETY & MAINTENANCE (CONT'D)

OPERATOR CAB	10-30-1
Description	10-30-1
Emergency Exit	10-30-3
Lowering The Operator Cab	10-30-2
Raising The Operator Cab	10-30-1
POWER BOB-TACH (OPTION)	10-141-1
Inspection And Maintenance	10-141-1
REMOTE START	10-60-1
Procedure	10-60-1
SERVICE SCHEDULE	10-70-1
Chart	10-70-1
SPARK ARRESTOR MUFFLER	10-160-1
Cleaning Procedure	10-160-1
TOWING THE LOADER (S/N 519313198 & ABOVE)	10-51-1
Procedure	10-51-1
TOWING THE LOADER (S/N 519313197 & BELOW)	10-50-1
Procedure	10-50-1
TRANSPORTING THE BOBCAT LOADER	10-40-1
Procedure	10-40-1

LIFTING AND BLOCKING THE LOADER



Instructions are necessary before operating or servicing machine. Read and understand the Operation & Maintenance Manual, Handbook and signs (decals) on machine. Follow warnings and instructions in the manuals when making repairs, adjustments or servicing. Check for correct function after adjustments, repairs or service. Untrained operators and failure to follow instructions can cause injury or death.

W-2003-0199

Figure 10-10-1

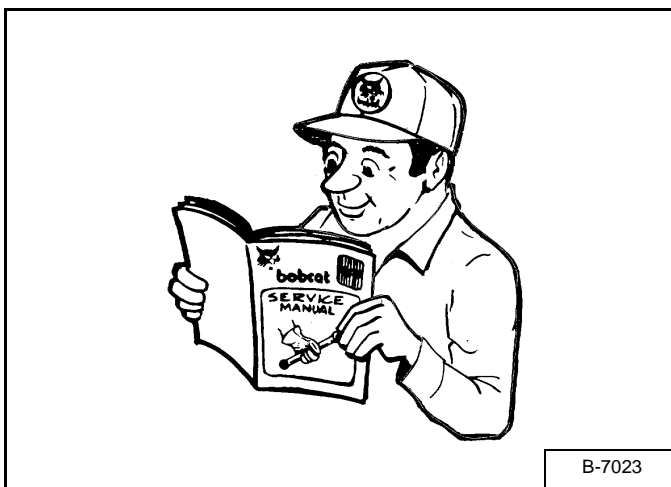

B-7023

Procedure



Put jackstands under the front axles and rear corners of the frame before running the engine for service. Failure to use jackstands can allow the machine to fall or move and cause injury or death.

W-2017-0286

Figure 10-10-2



P-24491

Always park the loader on a level surface.

Put floor jack under the rear of the loader [Figure 10-10-2].

Lift the rear of the loader and install jackstands [Figure 10-10-2].

Figure 10-10-3

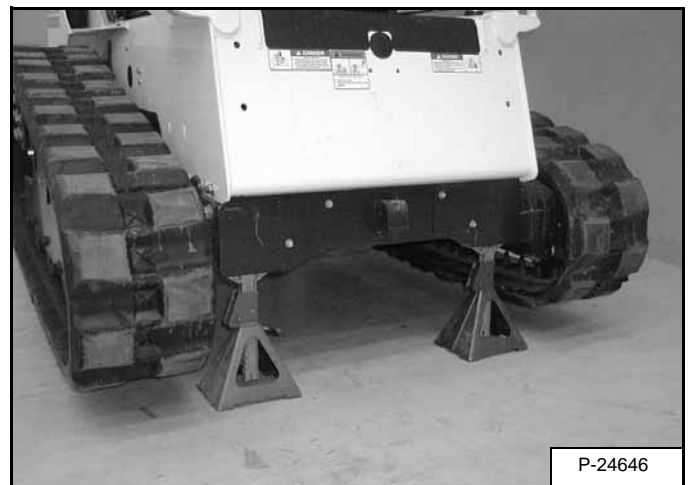

P-24646

Put the floor jack under the front of the loader [Figure 10-10-3].

Lift the front of the loader and put jackstands under the axle tubes [Figure 10-10-3].

NOTE: Make sure the jackstands do not touch the tires. Make sure tires clear floor or any obstacles.

LIFTING AND BLOCKING THE LOADER (CONT'D)

Single Point Lift

Figure 10-10-4

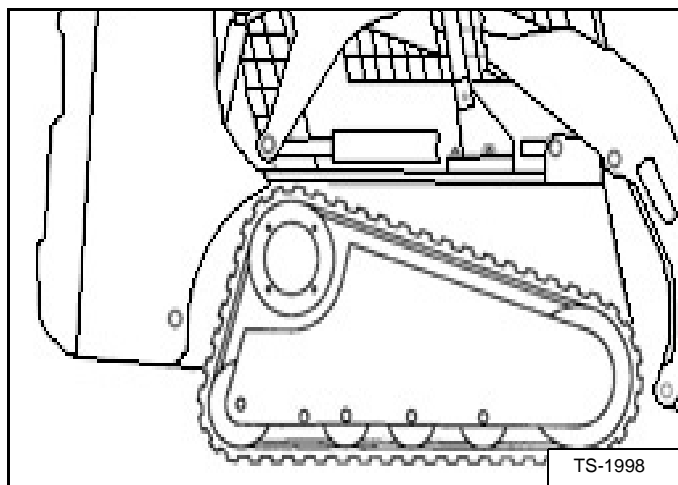

The loader can be lifted with the Single Point Lift which is available as a kit from your Bobcat loader dealer.

Install the kit as explained in the Instructions with the kit and attach lift as shown **[Figure 10-10-4]**.

The Single Point Lift, supplied by Bobcat, is designed to lift and support the Bobcat loader without affecting roll over and falling object protection features of the operator cab.

LIFT ARM SUPPORT DEVICE

Installing Lift Arm Support Device



Never work on a machine with the lift arms up unless the lift arms are secured by an approved lift arm support device. Failure to use an approved lift arm support device can allow the lift arms or attachment to fall and cause injury or death.

W-2059-0598



Service lift arm support device if damaged or if parts are missing. Using a damaged lift arm support or with missing parts can cause lift arms to drop causing injury or death.

W-2271-1197

Figure 10-20-1

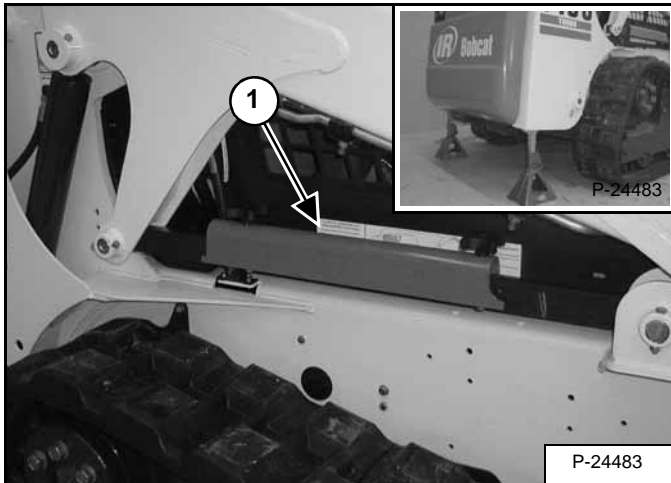

Put jackstands under the rear corners of the loader frame (Inset) [Figure 10-20-1].

Remove the lift arm support device (Item 1) [Figure 10-20-1] from storage position.

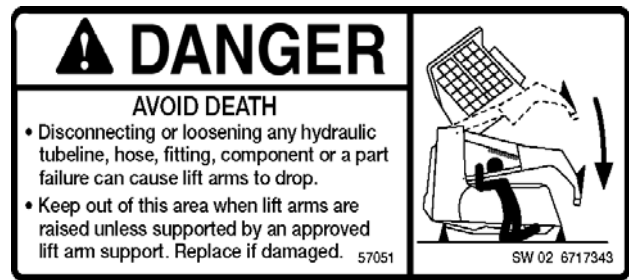
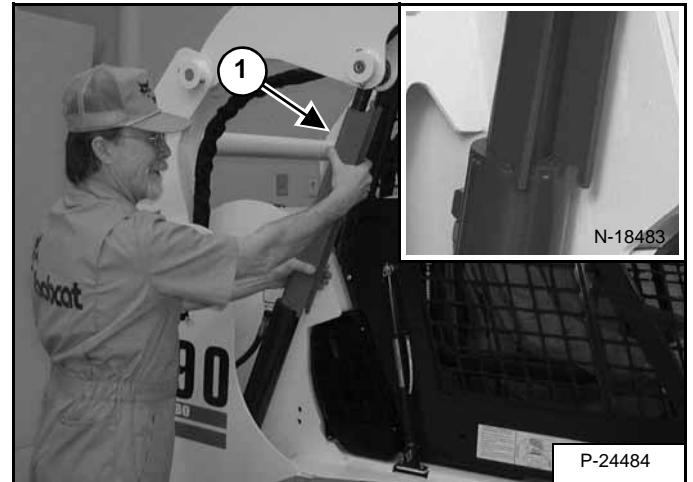

Figure 10-20-2



The operator must be in the operator's seat, with the seat belt fastened and seat bar lowered, until the lift arm support device is installed.

Start the engine, and raise the lift arms all the way up.

Have a second person install the lift arm support device (Item 1) [Figure 10-20-2] over the rod of one of the lift cylinders.

The lift arm support device must be tight against the cylinder rod. The tabs of the lift arm support device must be under the cylinder as shown (Inset) [Figure 10-20-2].

LIFT ARM SUPPORT DEVICE (CONT'D)

Installing Lift Arm Support Device (Cont'd)

Figure 10-20-3

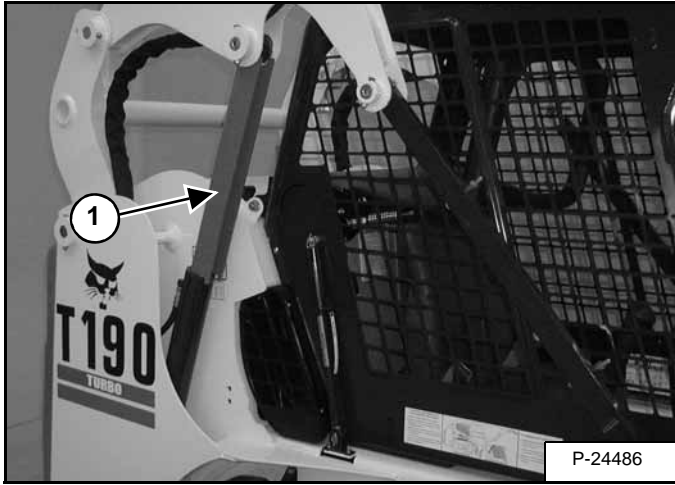

Lower the lift arms slowly until the lift arm support device (Item 1) [Figure 10-20-3] is held between the lift arms and lift cylinder.

Removing Lift Arm Support Device

The operator must be in the operator's seat, with the seat belt fastened and seat bar lowered, until the lift arm support device is removed and the lift arms are lowered all the way.

Start the engine, raise the lift arms all the way up.

Have a second person remove the lift arm support device.

Lower the lift arms all the way and stop the engine.

Return the lift arm support device to storage position and secure with clamping knobs.

Remove the jackstands.

OPERATOR CAB

Description

The Bobcat loader has an operator cab (ROPS and FOPS) as standard equipment to protect the operator from rollover and falling objects. Check with your dealer if the operator cab has been damaged. The seat belt must be worn for roll over protection.

ROPS/FOPS - Roll Over Protective Structure per SAE J1040 and ISO 3471, and Falling Object Protective Structure per SAE J1043 and ISO 3449, Level I. Level II is available.

Level I - Protection from falling bricks, small concrete blocks, and hand tools encountered in operations such as highway maintenance, landscaping, and other construction site services.

Level II - Protection from falling trees, rocks; for machines involved in site clearing, overhead demolition or forestry.

Raising The Operator Cab



Never modify operator cab by welding, grinding, drilling holes or adding attachments unless instructed to do so by Bobcat. Changes to the cab can cause loss of operator protection from rollover and falling objects, and result in injury or death.

W-2069-1299

Figure 10-30-1



Always stop the engine before raising or lowering the cab.

Stop the loader on a level surface. Lower the lift arms. If the lift arms must be up while raising the operator cab, install the lift arm support device. (See Installing Lift Arm Support Device on Page 10-20-1.)

Install jackstands under the rear of the loader frame [Figure 10-30-1].

Figure 10-30-2

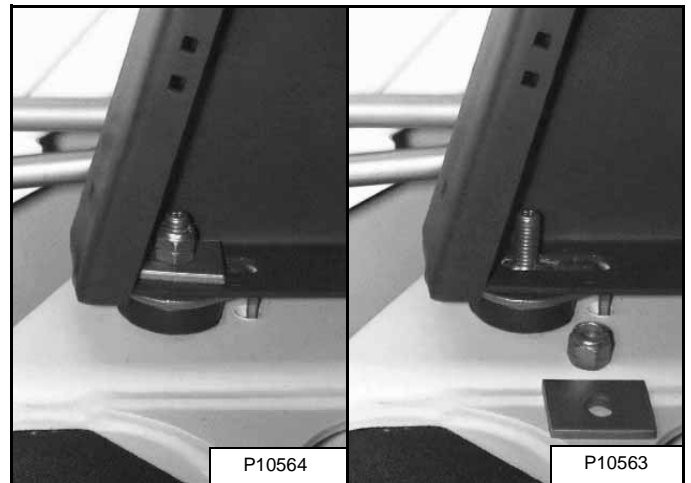

Loosen the nut (both sides) at the front corners of the operator cab [Figure 10-30-2].

Remove the nuts and plates [Figure 10-30-2] (both sides).

OPERATOR CAB (CONT'D)

Raising The Operator Cab (Cont'd)

Figure 10-30-3

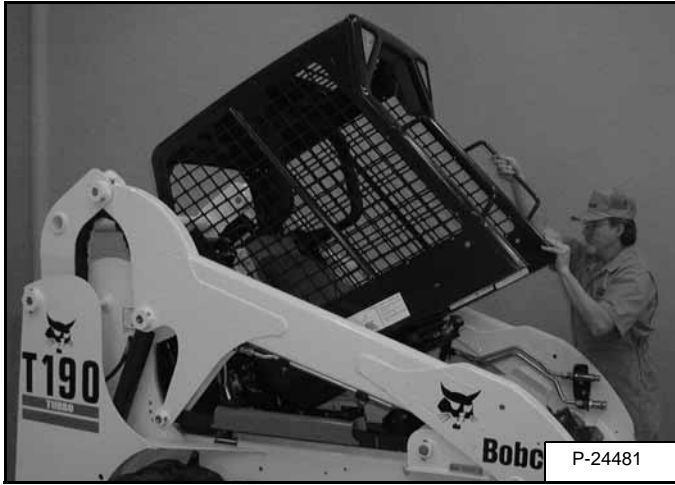

Lift on the grab handle and bottom of the operator cab slowly until the cab is all the way up and the latching mechanism engages [Figure 10-30-3].

Hand Controls (ACS)

Lowering The Operator Cab

Figure 10-30-4

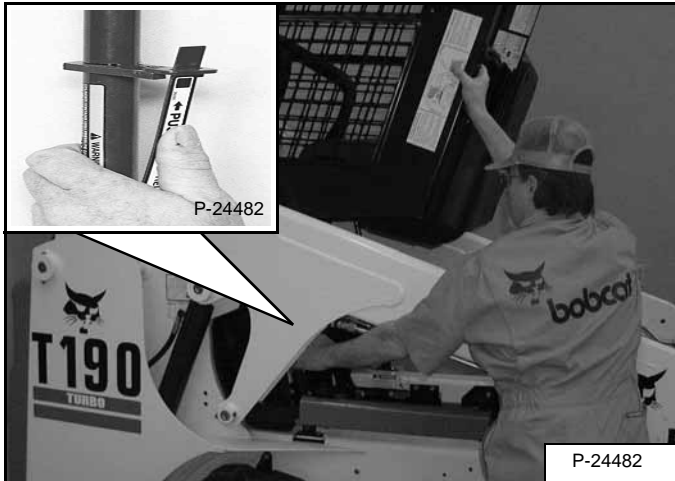

Always stop the engine before raising or lowering the cab.

NOTE: Make sure the seat bar is fully raised or lowered when lowering the cab. Always use the grab handles to lower the cab.

Pull down on the bottom of the operator cab until it stops at the latching mechanism [Figure 10-30-4].

Release the latching mechanism (Inset) [Figure 10-30-4] and pull the cab all the way down.

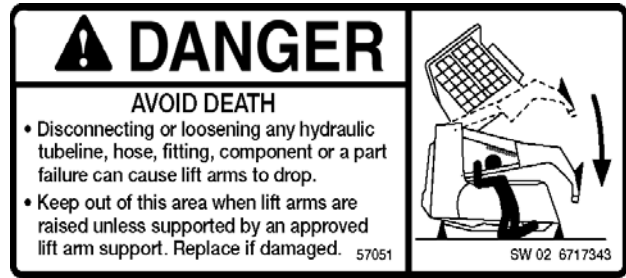
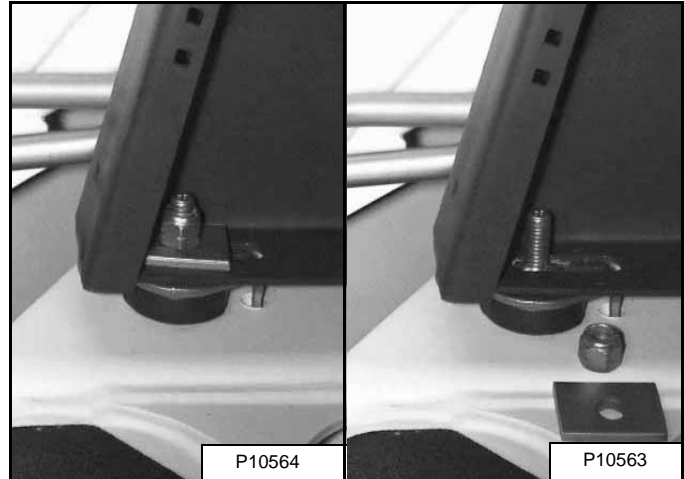

Figure 10-30-5



Install the plates and nuts [Figure 10-30-5] (both sides).

Tighten the nuts to 40-50 ft.-lbs. (54-68 Nm) torque.

OPERATOR CAB (CONT'D)

Emergency Exit

Figure 10-30-6



The front opening on the operator cab and rear window provide exits.

Rear Window (If Equipped)

Pull on the tag on the top of the rear window to remove the rubber cord [Figure 10-30-6].

Figure 10-30-7



Push the rear window out of the rear of the operator cab.

Exit through the rear of the operator cab [Figure 10-30-7].

Figure 10-30-8

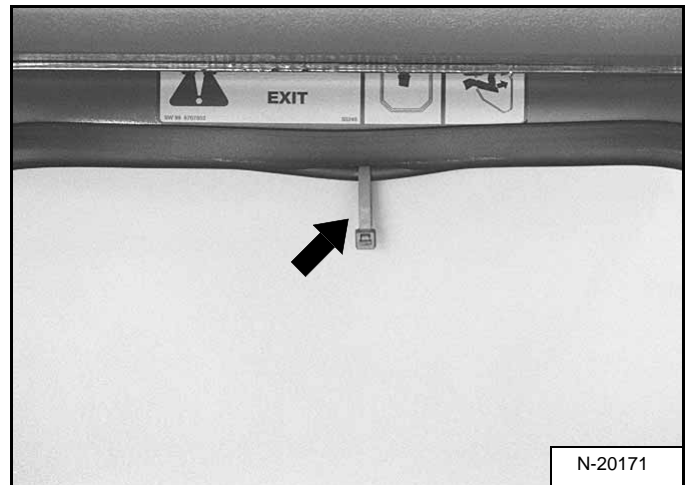

Front Door (If Equipped)

NOTE: When an Operator Cab Enclosure Kit is installed, the window of the front door can be used as an emergency exit. [Figure 10-30-8]

NOTE: If the loader has a Special Application Door Kit installed, the window of the front door is **NOT** an emergency exit.

Pull the plastic loop at the top of the window in the front door to remove the rubber cord [Figure 10-30-8].

Figure 10-30-9

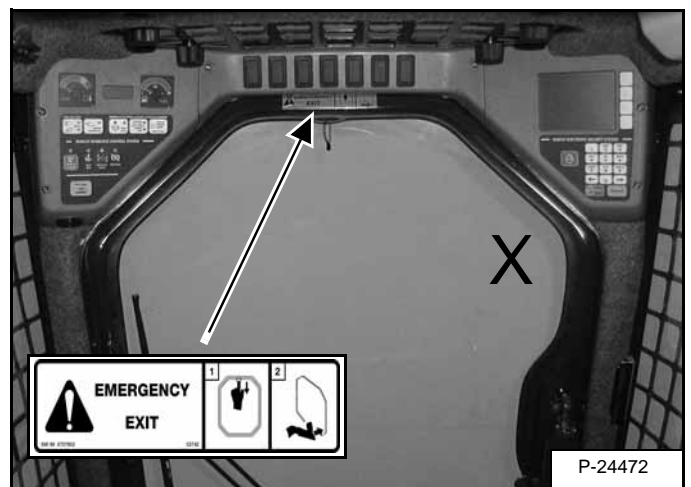

Push the window out with your foot [Figure 10-30-9] at any corner of the window.

Exit through the front door.

TRANSPORTING THE BOBCAT LOADER

Procedure



Adequately designed ramps of sufficient strength are needed to support the weight of the machine when loading onto a transport vehicle. Wood ramps can break and cause personal injury.

W-2058-0494

Figure 10-40-1

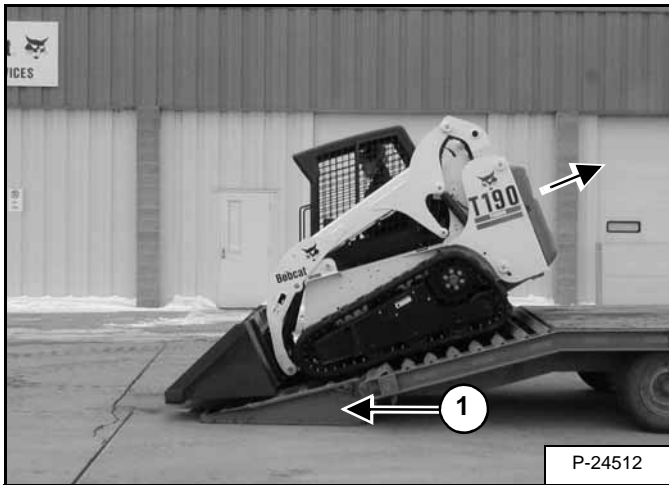

Be sure the transport and towing vehicles are of adequate size and capacity (See Performance on Page SPEC-10-2.).

A loader with an empty bucket or no attachment must be loaded backward onto the transport vehicle [Figure 10-40-1].

The rear of the trailer must be blocked or supported (Item 1) [Figure 10-40-1] when loading or unloading the loader to prevent the front end of the trailer from raising up.

Figure 10-40-2

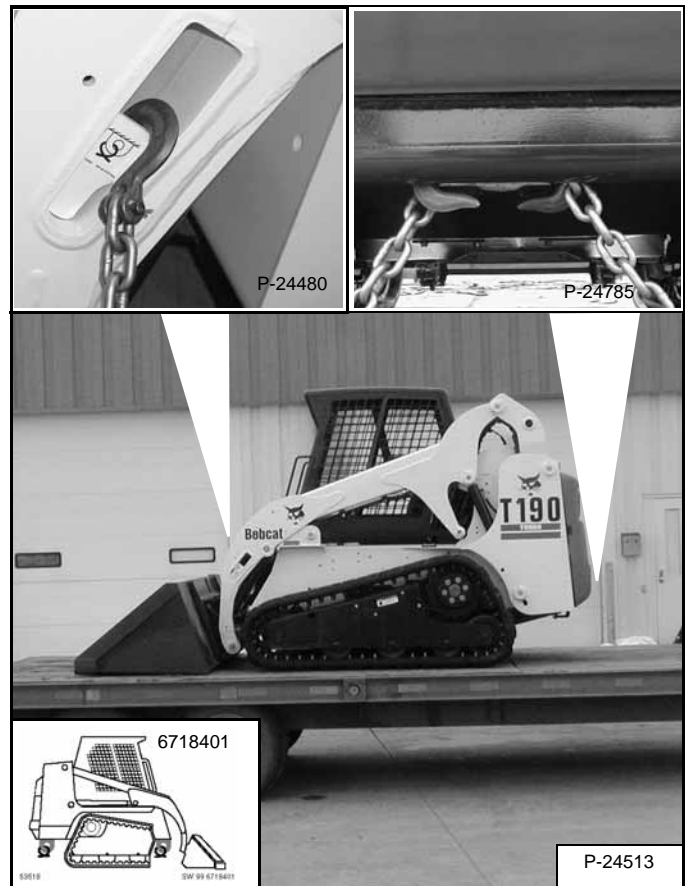

Use the following procedure to fasten the Bobcat loader to the transport vehicle to prevent the loader from moving during sudden stops or when going up or down slopes [Figure 10-40-2].

- Lower the bucket or attachment to the floor.
- Stop the engine.
- Engage the parking brake.
- Install chains at the front and rear loader tie down positions (Inset) [Figure 10-40-2].
- Fasten each end of the chain to the transport vehicle.

TOWING THE LOADER (S/N 519313197 & BELOW)

Procedure



Never work on a machine with the lift arms up unless the lift arms are secured by an approved lift arm support device. Failure to use an approved lift arm support device can allow the lift arms or attachment to fall and cause injury or death.

W-2059-0598

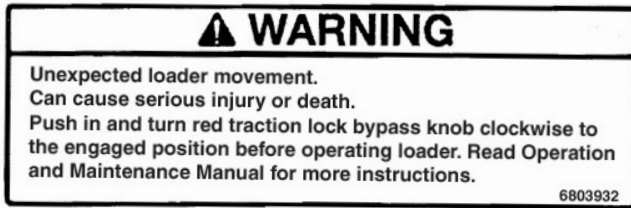
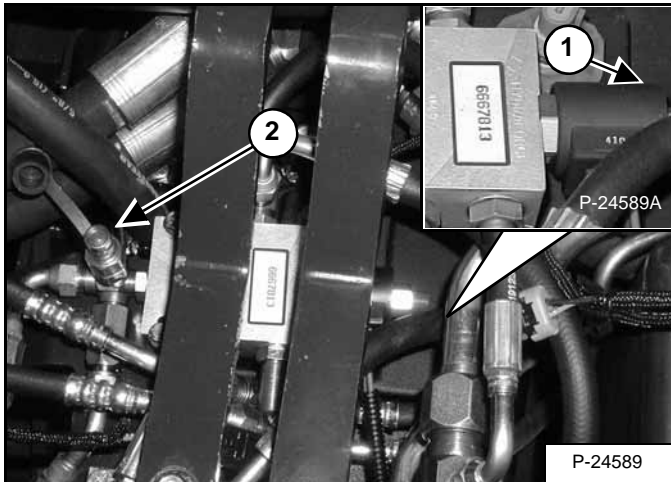

Figure 10-50-1



Tow the loader only a short distance at slow speed. (Example: Moving the loader onto a transport vehicle).

The towing chain (or cable) must be rated at 1 & 1/2 times the weight of the loader. (See Performance on Page SPEC-10-2.)

The hydraulic brakes must be disengaged to allow towing of the loader.

Raise the operator cab. (See Raising The Operator Cab on Page 10-30-1.)

Disengage the parking brake solenoid valve by pushing **IN** on the red Traction Lock By-Pass Knob (Item 1) [Figure 10-50-1] and turning it **1/4 TURN counterclockwise** . The knob will come out to release the solenoid valve.

Connect a Port-a-Power to the quick coupler located near the brake block (Item 2) [Figure 10-50-1] .

Operate the Port-a-Power to 400 PSI (2758 kPa) to release the brake.

Lower the cab and tow the loader.

NOTE: Pressure must be maintained between 200 & 400 PSI (13,8 & 27,6 BAR). Operate the Port-a-Power again if necessary to release the brake and move the loader.

Before operating the loader again, disconnect the Port-a-Power and engage the parking brake solenoid valve, by pushing **IN** on the red Traction Lock By-Pass Knob (Item 1) [Figure 10-50-1] and turning it **1/4 TURN clockwise**.

TOWING THE LOADER (S/N 519313198 & ABOVE)

Procedure



Never work on a machine with the lift arms up unless the lift arms are secured by an approved lift arm support device. Failure to use an approved lift arm support device can allow the lift arms or attachment to fall and cause injury or death.

W-2059-0598

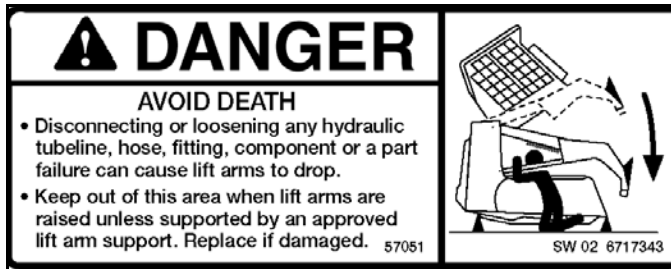

Tow the loader only a short distance at slow speed. (Example: Moving the loader onto a transport vehicle).

The towing chain (or cable) must be rated at 1 & 1/2 times the weight of the loader. (See Performance on Page SPEC-10-2.)

The hydraulic brakes must be disengaged to allow towing of the loader.

Figure 10-51-1

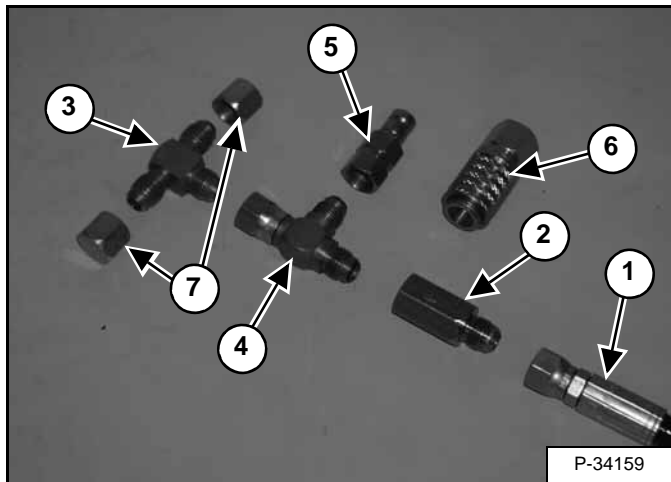

The parts from the list below are required to complete the towing tool needed in this procedure [Figure 10-51-1]:

- 1 - 2 ft. Common Drain Hose (Item 1)
- 1 - 6678026 - Check Relief Valve (500 PSI) (Item 2)
- 1 - 10K-5 - Tee Fitting (Item 3)

- 1 - 13K-5 - Swivel fitting (Item 4)
- 1 - 6661753 - Coupler, Male (Item 5)
- 1 - MEL1218 - Coupler, Female (Item 6)
- 2 - 36K-5 - Caps (Item 7)

Connect the drain hose (Item 1) to the check valve (Item 2) [Figure 10-51-1].

Connect the tee fitting (Item 3), check valve (Item 2), and the coupler (Item 5) to the swivel fitting (Item 4) [Figure 10-51-1].

Figure 10-51-2

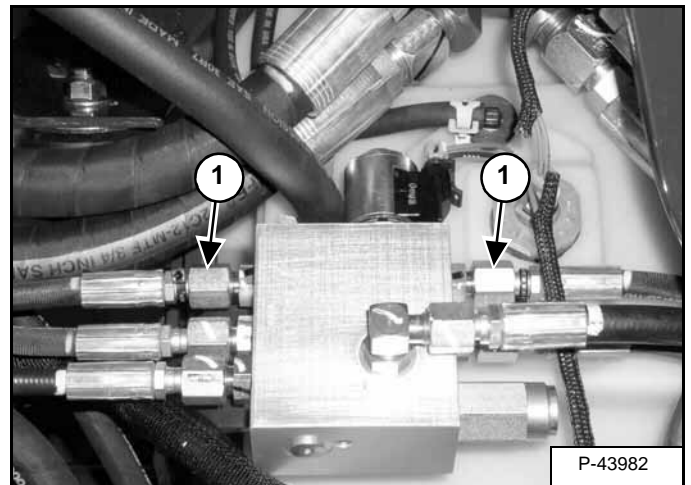

Raise the operator cab. (See Raising The Operator Cab on Page 10-30-1.)

Disconnect the brake release hoses (Item 1) [Figure 10-51-2] from the brake valve block. Cap the fittings on the brake valve block.

**TOWING THE LOADER (S/N 519313198 & ABOVE)
(CONT'D)**

Procedure (Cont'd)

Figure 10-51-3

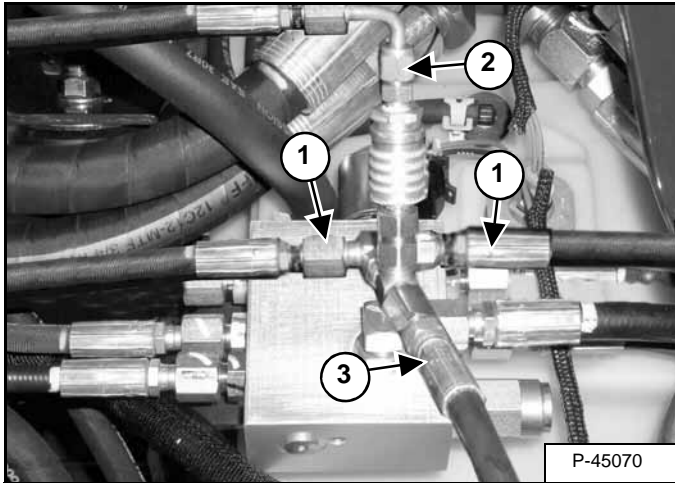

Connect the two brake release hoses (Item 1) **[Figure 10-51-3]** to the tee fitting.

Connect the port-a-power hose (Item 2) **[Figure 10-51-3]** (with an attached pressure gauge 600 PSI (4137kPa) or larger) to the quick coupler on the towing tool.

Route the drain hose (Item 3) **[Figure 10-51-3]** into a bucket.

Operate the Port-a-Power to 350-400 PSI (2413-2758 kPa) to release the brakes.

Lower the cab and tow the loader.

NOTE: Pressure must be maintained at 350- 400 PSI (2413-2758 kPa). Operate the Port-a-Power again if necessary to release the brake and move the loader.

Before operating the loader again the Port-a-Power pressure must be released and the brake release hoses must be connected to the brake valve block. Operate the brake to check that the brake operates properly.

REMOTE START

Procedure



AVOID INJURY OR DEATH

With the 7-pin connector plugged into the loader and Remote Start Key Switch in the OFF position, the loader can still be started from the operator panel inside the cab. Placing the key switch of the remote start tool in the run position disconnects the operator panel key switch from the start circuit. If the service technician will be working the engine area it is important to remove the operator panel keys.

W-2357-0899

Figure 10-60-1

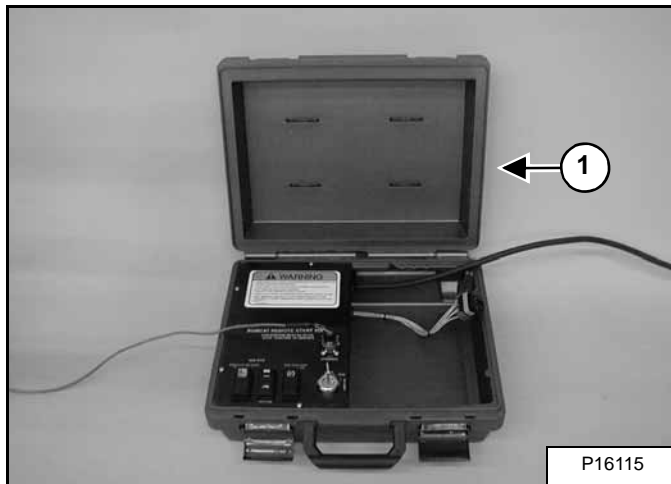

The tool listed will be need to do the following procedure:

MEL1563 - Remote Start Tool Kit

The remote start (Item 1) [Figure 10-60-1] is required when the operator cab is in the raised position for service and the service technician needs to turn the key switch on or start the engine. Example: Control Handle: linkage neutral adjustment.

Figure 10-60-2

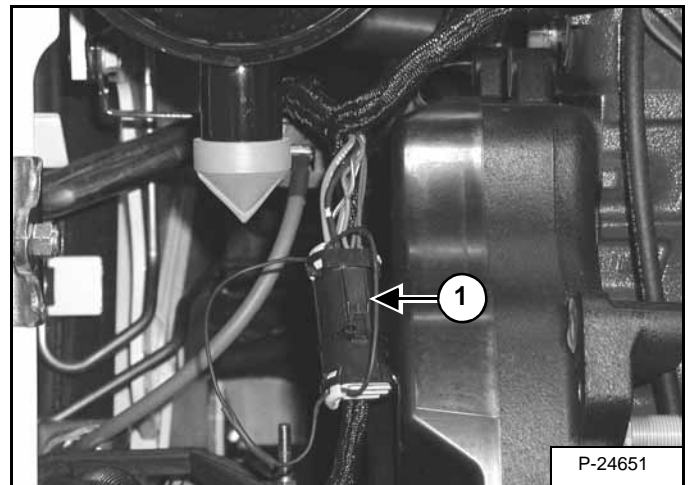
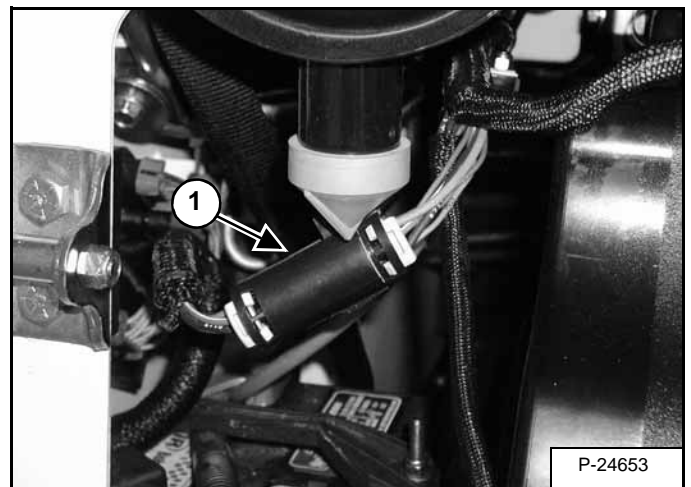

Figure 10-60-3



Lift and block the loader. (See LIFTING AND BLOCKING THE LOADER on Page 10-10-1.)

Raise the lift arms (if required by the procedure) and install an approved lift arm support device. (See Installing Lift Arm Support Device on Page 10-20-1.)

Raise the operator cab (if required by the procedure). (See Raising The Operator Cab on Page 10-30-1.)

Open the rear door of the loader.

Remove the plug (Item 1) [Figure 10-60-2] or disconnect the attachment control harness (Item 1) [Figure 10-60-3] if connected.

REMOTE START (CONT'D)

Procedure (Cont'd)

Figure 10-60-4

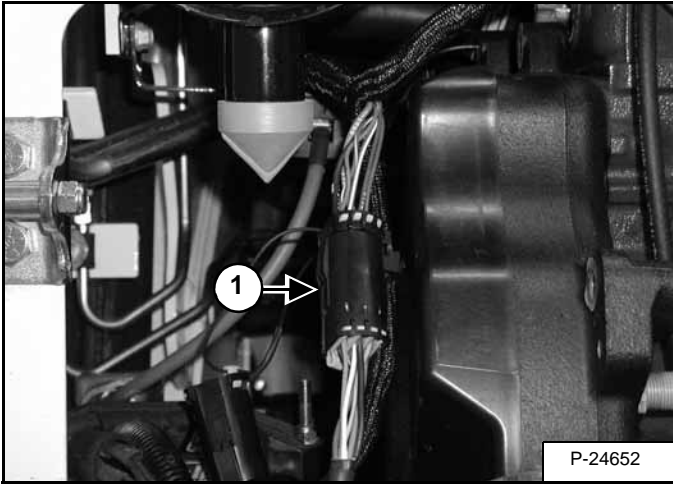

Connect the remote start tool to the engine harness connector (Item 1) [Figure 10-60-4].

NOTE: The key switch on the right-hand side operator panel must be in the off position or the Remote Start Kit will not operate.

Figure 10-60-5



The remote start tool (Item 1) [Figure 10-60-5] has three rocker switches.

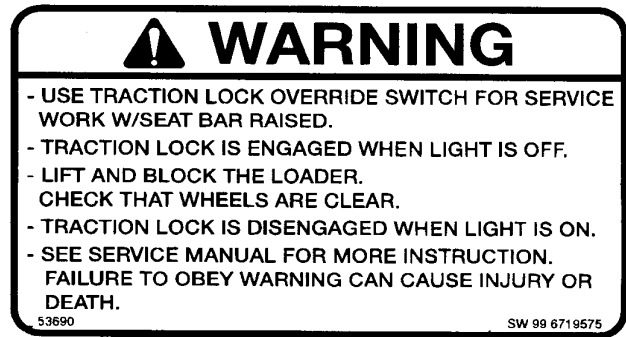
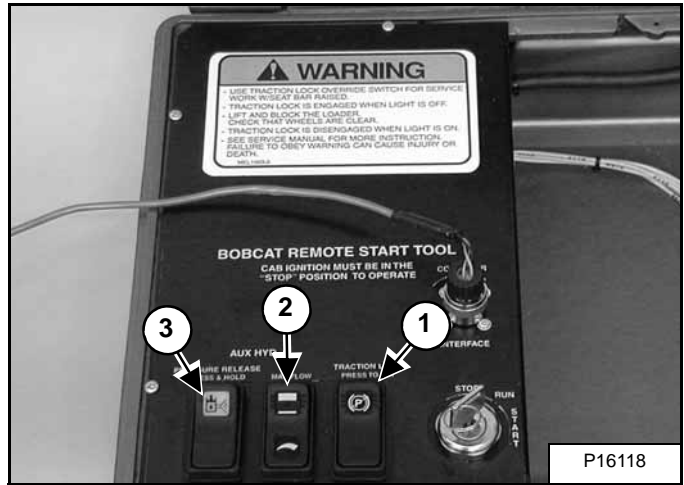

Figure 10-60-6



The traction lock switch (Item 1) [Figure 10-60-6] is used to turn traction lock on or off. Push the switch to the override position. The switch will illuminate to indicate traction lock **VERRIDE**, in this position the wheels are able to turn.

The maximum flow/variable flow switch (Item 2) [Figure 10-60-6] is used to activate the auxiliary hydraulics. Pressing the switch once will activate variable flow. Pressing the switch again will activate maximum flow. The switch will illuminate to indicate which flow rate is active. Pressing the switch a third time will turn the flow **OFF**. The switch is used when checking pressures and flow rate.

The auxiliary pressure release (Item 3) [Figure 10-60-6] is used to release hydraulic pressure to the front and/or rear auxiliary couplers. To release pressure; push and hold the switch for three seconds.

NOTE: With the engine running; pushing and holding the pressure release switch will cause the engine to stop in three seconds. To relieve the pressure; continue to press the switch after the engine has stopped.



Suggest:

If the above button click is invalid.

Please download this document

first, and then click the above link

to download the complete manual.

Thank you so much for reading

SERVICE SCHEDULE

Chart

Maintenance work must be done at regular intervals. Failure to do so will result in excessive wear and early failures. The service schedule is a guide for correct maintenance of the Bobcat loader

 <b style="font-size: 24pt; margin-left: 10px;">WARNING	<p>Instructions are necessary before operating or servicing machine. Read and understand the Operation & Maintenance Manual, Operator's Handbook and signs (decals) on machine. Follow warnings and instructions in the manuals when making repairs, adjustments or servicing. Check for correct function after adjustments, repairs or service. Untrained operators and failure to follow instructions can cause injury or death.</p> <p style="text-align: right; font-size: 10pt;">W-2003-0903</p>
--	--

SERVICE SCHEDULE		HOURS					
ITEM	SERVICE REQUIRED	8-10	50	100	■ 250	■ 500	■ 1000
Engine Oil	Check the oil level and add oil as needed.						
Engine Air Filter and Air System	Check display panel. Service only when required. Check for leaks and damaged components.						
Engine Cooling System	Clean debris from oil cooler, radiator and grill. Check coolant level in recovery tank. Add coolant as needed.						
Seat Belt, Seat Bar and Control Interlocks	Check the condition of seat belt. Check the seat bar and control interlocks. Clean dirt and debris from moving parts.						
Safety Signs and Safety Tread	Check for damaged signs (decals) and safety treads. Replace any signs or safety treads that are damaged or worn.						
Indicators & Lights (Opt.)	Check for correct operation of all indicators & lights.						
Operator Cab	Check the fastening bolts, washers & nuts. Check the condition of cab.						
Lift Arms, Cylinders, Bob-Tach Pivot Pins and Wedges	Lubricate with multi-purpose lithium based grease.						
Fuel Filter	Remove the trapped water.						
Bobcat Interlock Control System (BICS™)	Check that four (4) BICS™ indicator lights and functions are acti- vated. See details in this Operation & Maintenance Manual.						
Heater and A/C Filters	Clean or replace filters as needed during heating/cooling season.						
Tracks	Check for damaged or worn tracks and correct tension.	‡					
Hydraulic Fluid, Hoses and Tubelines	Check fluid level and add as needed. Check for damage and leaks. Repair or replace as needed.						
Foot Pedals or Hand Controls, and Steering Levers	Check for correct operation. Repair or adjust as needed.						
Parking Brake	Check operation.						
Track Sprocket Bolts	Check torque. Tighten as needed. See procedure is this manual.		◆				
Spark Arrestor Muffler	Clean the spark chamber.						
Battery	Check cables, connections and electrolyte level. Add distilled water as needed.						
Steering Shaft	Grease two fittings.						
Engine/Hydros. Drive Belt	Check for wear or damage. Adjust as needed.		*				
Fan Drive Gearbox	Check gear lube level. Add as needed.						
Alternator Belt & Air Conditioner Belt (If Equipped)	Check belt tension and adjust as needed.						
Engine Oil and Filter	Replace oil and filter. Use CD or better grade oil and Bobcat filter.		†				
Fuel Filter	Replace the filter element.						
Bobcat Interlock Control System (BICS™)	Check the function of the lift arm bypass control.						
Hydraulic Reservoir Breather Cap	Replace the reservoir breather cap.						
Hydraulic/Hydrostatic Filter	Replace the filter element.		•				
Hydraulic Reservoir	Replace the fluid.						
Case Drain Filters	Replace the filters.						■
Track Rollers & Idlers (Early)	Replace oil. Use SAE 80W-90 Gear Lube. [3.4 oz. (100 cc) each roller & idler]						
Hydrostatic Motor Carrier	Replace Oil with High Performance Synthetic Oil P/N 6682546.						

■ Or every 12 months.

† First oil and filter change must occur at 50 hours; 250 hours thereafter.

* Inspect the new belt after first 50 hours.

• Replace filter element after the first 50 hours and when the transmission warning light comes ON.

‡ Check every 8-10 hours for the first 50 hours. Then at 50 hour intervals.

◆ Check after the first 50 hours of operation only.

<https://www.ebooklibonline.com>

Hello dear friend!

Thank you very much for reading.

Enter the link into your browser.

The full manual is available for immediate download.

<https://www.ebooklibonline.com>