

# T140



# Bobcat®

## Service Manual

S/N 527111001 & Above  
S/N 527211001 & Above

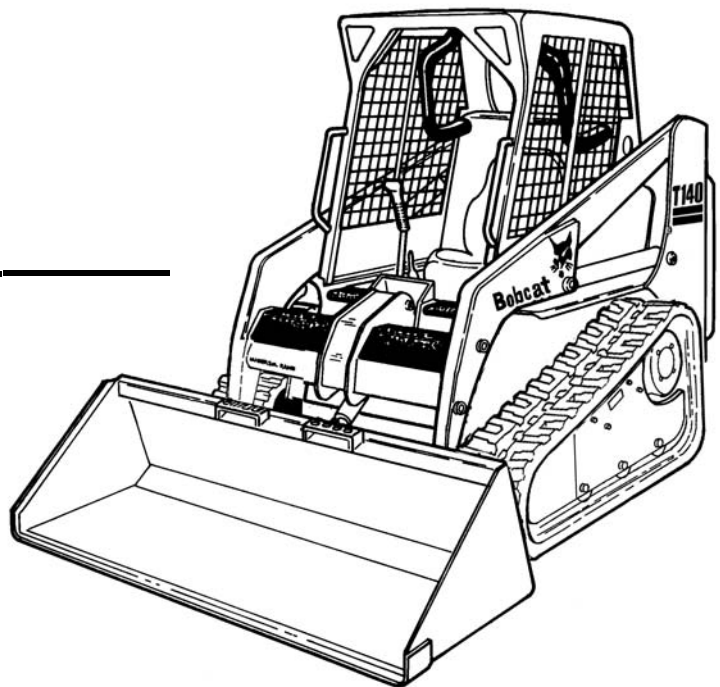

EQUIPPED WITH  
BOBCAT INTERLOCK  
CONTROL SYSTEM (BICS™)

6903153 (2-06)

 **Ingersoll Rand**  
Compact Vehicle Technologies

Printed in U.S.A.

© Bobcat Company 2006

## ALPHABETICAL INDEX

ADVANCED CONTROL SYSTEM (ACS)		
SELECTRABLE HAND/FOOT CONTROL.....	60-01	
ALTERNATOR .....	60-01	
AIR CLEANER SERVICE .....	10-01, 70-01	
BASIC TROUBLESHOOTING .....	80-01	
BATTERY .....	60-01	
BICS™ SYSTEM .....	60-01	
BOBCAT CONTROLLER .....	60-01	
BOB-TACH.....	10-01, 50-01	
BRAKE .....	40-01	
BUCKET POSITION VALVE.....	20-01	
CHARGE PRESSURE .....	30-01	
COMPONENTS .....	80-01	
CONTROL HANDLE .....	50-01	
CONTROL PANEL .....	50-01	
CONTROL PEDALS .....	50-01	
CONTROL PEDALS (ACS) .....	50-01	
CONVERSIONS .....	SPEC-01	
COOLING FAN .....	70-01	
CYLINDER (LIFT).....	20-01	
CYLINDER (POWER BOB-TACH).....	20-01	
CYLINDER (TILT) .....	20-01	
DIAGNOSTICS SERVICE CODES.....	60-01	
DRIVE BELT .....	30-01	
DRIVE COMPONENTS .....	40-01	
ELECTRICAL/HYD. CONTROLS REFERENCE ....	60-01	
ELECTRICAL SYSTEM INFORMATION .....	60-01	
ENGINE .....	70-01	
ENGINE COMPONENTS AND TESTING .....	70-01	
ENGINE COOLING SYSTEM.....	10-01	
ENGINE LUBRICATION SYSTEM .....	10-01	
ENGINE SPECIFICATIONS.....	SPEC-01	
ENGINE SPEED CONTROL .....	70-01	
FAN GEARBOX .....	10-01	
FINAL DRIVE TRANSMISSION (CHAINCASE).....	10-01	
FLYWHEEL AND HOUSING.....	70-01	
FLYWHEEL RPM SENSOR.....	60-01	
FRONT AUXILIARY HYDRAULIC		
COUPLER BLOCK .....	20-01	
FUEL SYSTEM .....	10-01	
FUEL TANK.....	50-01	
HEATER UNIT .....	80-01	
HEATER COIL .....	80-01	
HEATER FAN .....	80-01	
HEATER VALVE.....	80-01	
HYDRAULIC CONNECTION SPECS.....	SPEC-01	
HYDRAULIC CONTROL VALVE (ADVANCED		
CONTROL SYSTEM) (ACS).....	20-01	
HYDRAULIC CONTROL VALVE		
(FOOT CONTROL) .....	20-01	
HYDRAULIC FLUID RESERVOIR .....	20-01	
HYDRAULIC/HYDROSTATIC FILTER .....	20-01	
HYDRAULIC FLUID SPECIFICATIONS.....	SPEC-01	
HYDRAULIC/HYDROSTATIC SYSTEM.....	10-01	
HYDRAULIC SYSTEM INFORMATION .....	20-01	
HYDRAULIC PUMP .....	20-01	
HYDROSTATIC MOTOR .....	30-01	
HYDROSTATIC PUMP .....	30-01	
HYDROSTATIC SYSTEM INFORMATION.....	30-01	
INSTRUMENT PANEL .....	60-01	
LIFT ARM .....	50-01	
LIFT ARM BY-PASS CONTROL VALVE.....	20-01	
LIFT ARM SUPPORT DEVICE.....	10-01	
LIFTING AND BLOCKING THE LOADER.....	10-01	
LIGHTS.....	60-01	
LOADER SPECIFICATIONS .....	SPEC-01	
LUBRICATION OF THE BOBCAT LOADER .....	10-01	
MAIN RELIEF VALVE .....	20-01	
MUFFLER.....	70-01	
OIL COOLER.....	30-01	
OPERATOR CAB .....	10-01, 50-01	
OPERATOR SEAT .....	50-01	
POWER BOB-TACH.....	10-01, 50-01	
POWER BOB-TACH BLOCK.....	20-01	
RADIATOR.....	70-01	
REAR AUXILIARY DEVERTER .....	20-01	
REAR DOOR .....	50-01	
REAR GRILL .....	50-01	
RECONDITIONING THE ENGINE .....	70-01	
REGULAR MAINTENANCE .....	80-01	
REMOTE START .....	10-01	
SEAT BAR.....	50-01	
SEAT BAR SENSOR.....	60-01	
SERVICE SCHEDULE.....	10-01	
SPARK ARRESTOR MUFFLER.....	10-01	
STARTER .....	60-01	
SYSTEM TROUBLESHOOTING CHART .....	80-01	
TORQUE SPECIFICATIONS FOR BOLTS .....	SPEC-01	
TOWING THE LOADER .....	10-01	
TRACTION LOCK .....	60-01	
TRANSPORTING THE LOADER .....	10-01	
TROUBLESHOOTING .....	70-01	

# MAINTENANCE SAFETY



## WARNING

Instructions are necessary before operating or servicing machine. Read and understand the Operation & Maintenance Manual, Operator's Handbook and signs (decals) on machine. Follow warnings and instructions in the manuals when making repairs, adjustments or servicing. Check for correct function after adjustments, repairs or service. Untrained operators and failure to follow instructions can cause injury or death.

W-2003-0903



**Safety Alert Symbol:** This symbol with a warning statement, means: "Warning, be alert! Your safety is involved!" Carefully read the message that follows.

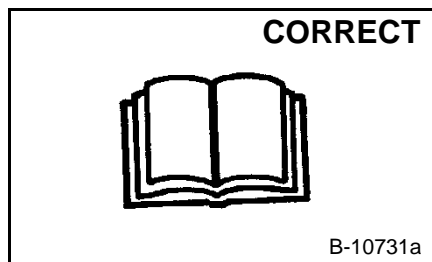

⚠ Never service the Bobcat Compact Track Loader without instructions.

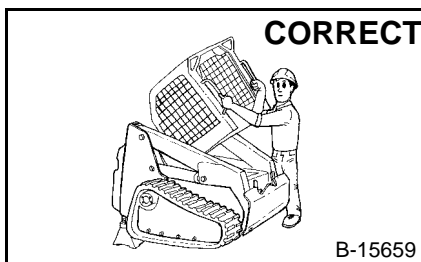

⚠ Use the correct procedure to lift or lower operator cab.

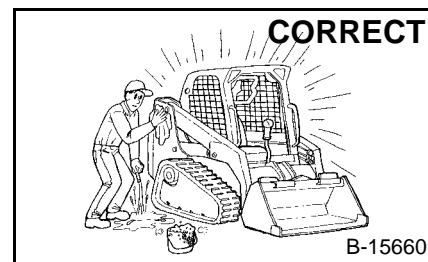

⚠ Cleaning and maintenance are required daily.

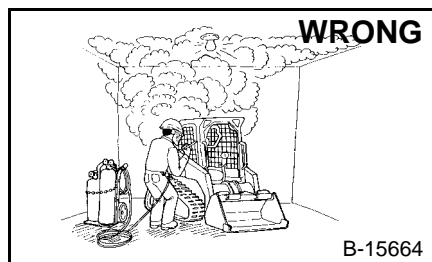

⚠ Have good ventilation when welding or grinding painted parts.  
 ⚠ Wear dust mask when grinding painted parts. Toxic dust and gas can be produced.  
 ⚠ Avoid exhaust fume leaks which can kill without warning. Exhaust system must be tightly sealed.

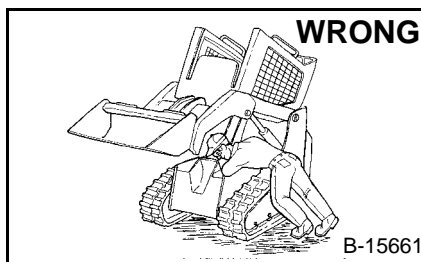

⚠ Disconnecting or loosening any hydraulic tubeline, hose, fitting, component or a part failure can cause lift arms to drop. Do not go under lift arms when raised unless supported by an approved lift arm support device. Replace it if damaged.

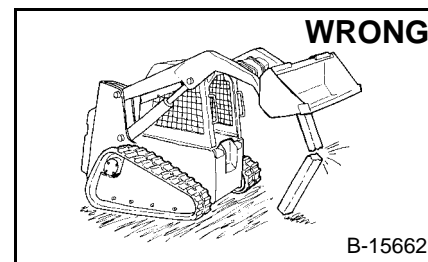

⚠ Never work on loader with lift arms up unless lift arms are held by an approved lift arm support device. Replace if damaged.  
 ⚠ Never modify equipment or add attachments not approved by Bobcat Company.

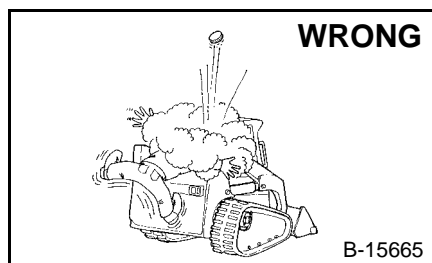

⚠ Stop, cool and clean engine of flammable materials before checking fluids.  
 ⚠ Never service or adjust loader with the engine running unless instructed to do so in the manual.  
 ⚠ Avoid contact with leaking hydraulic fluid or diesel fuel under pressure. It can penetrate the skin or eyes.  
 ⚠ Never fill fuel tank with engine running, while smoking or when near open flame.

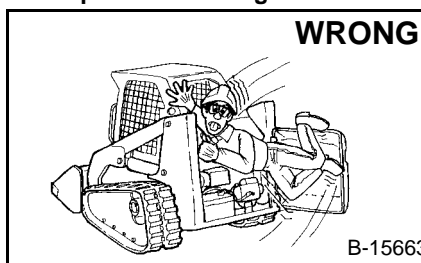

⚠ Keep body, jewelry and clothing away from moving parts, electrical contact, hot parts and exhaust.  
 ⚠ Wear eye protection to guard from battery acid, compressed springs, fluids under pressure and flying debris when engines are running or tools are used. Use eye protection approved for type of welding.  
 ⚠ Keep rear door closed except for service. Close and latch door before operating the loader.



⚠ Lead-acid batteries produce flammable and explosive gases.  
 ⚠ Keep arcs, sparks, flames and lighted tobacco away from batteries.  
 ⚠ Batteries contain acid which burns eyes or skin on contact. Wear protective clothing. If acid contacts body, flush well with water. For eye contact flush well and get immediate medical attention.

Maintenance procedures which are given in the Operation & Maintenance Manual can be performed by the owner/operator without any specific technical training. Maintenance procedures which are **not** in the Operation & Maintenance Manual must be performed **ONLY BY QUALIFIED BOBCAT SERVICE PERSONNEL**. Always use **genuine Bobcat replacement parts**. The Service Safety Training Course is available from your Bobcat dealer.

**<https://www.ebooklibonline.com>**

Hello dear friend!

Thank you very much for reading.

Enter the link into your browser.

The full manual is available for immediate download.

**<https://www.ebooklibonline.com>**

## CONTENTS

**SAFETY &  
MAINTENANCE**

**HYDRAULIC  
SYSTEM**

**HYDROSTATIC  
SYSTEM**

**DRIVE  
SYSTEM**

**MAIN FRAME**

**ELECTRICAL  
SYSTEM &  
ANALYSIS**

**ENGINE  
SERVICE**

**HEATER**

**SPECIFICATIONS**

FOREWORD.....	II
SAFETY INSTRUCTIONS .....	V
SERIAL NUMBER LOCATIONS .....	IX
DELIVERY REPORT.....	X
LOADER IDENTIFICATION .....	XI
SAFETY AND MAINTENANCE.....	10-01
HYDRAULIC SYSTEM .....	20-01
HYDROSTATIC SYSTEM.....	30-01
DRIVE SYSTEM .....	40-01
MAIN FRAME .....	50-01
ELECTRICAL SYSTEM & ANALYSIS.....	60-01
ENGINE SERVICE .....	70-01
HEATER .....	80-01
SPECIFICATIONS.....	SPEC-01

# FOREWORD

This manual is for the Bobcat loader mechanic. It provides necessary servicing and adjustment procedures for the Bobcat loader and its component parts and systems. Refer to the Operation & Maintenance Manual for operating instructions, starting procedure, daily checks, etc.

A general inspection of the following items must be made after the loader has had service or repair:

1. Check that the ROPS/FOPS (Including side screens) is in good condition and is not modified.

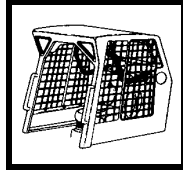

2. Check that ROPS mounting hardware is tightened and is Bobcat approved.

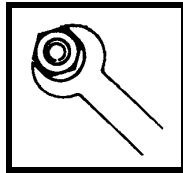

3. The seat belt must be correctly installed, functional and in good condition.

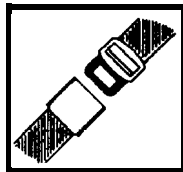

4. The seat bar must be correctly adjusted, clean and lubricated.

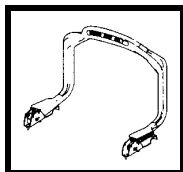

5. Check lift arm support device, replace if damaged.

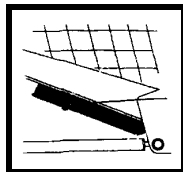

6. Machine signs must be legible and in the correct location.



7. Steering levers and foot pedals must return to neutral.

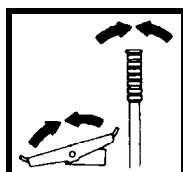

8. Check for correct function of the work lights



9. The parking brake must function correctly.

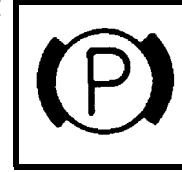

10. Enclosure door latches must open and close freely.

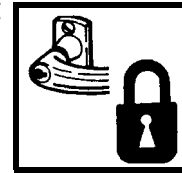

11. Bob-Tach wedges and linkages must function correctly and be in good condition.

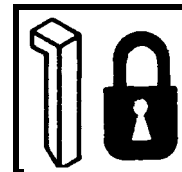

12. Safety treads must be in good condition.

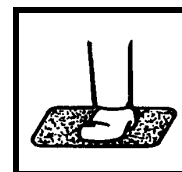

13. Check for correct function of indicator lamps (Optional on some models).

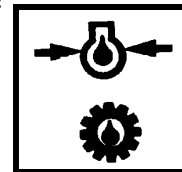

14. Check hydraulic fluid level, engine oil level and fuel supply.

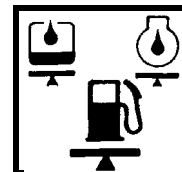

15. Inspect for fuel, oil or hydraulic fluid leaks.

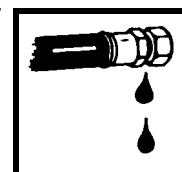

16. Lubricate the loader.



17. Check the condition of the battery and cables.

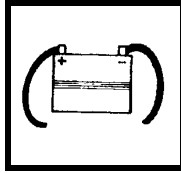

22. Operate the loader and check all functions.

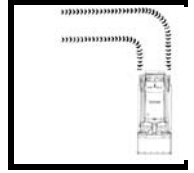

18. Inspect the air cleaner for damage or leaks. Check the condition of the element.

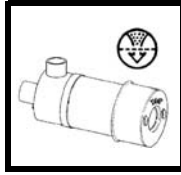

23. Check for any field modification not completed.



19. Check the electrical charging system.

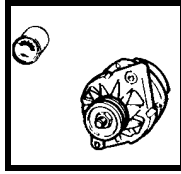

24. Check for correct function of the Bobcat Interlock Control System (BICST™) before the machine is returned to the customer.

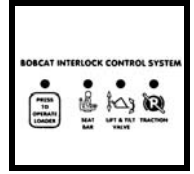

20. Check tracks for wear and tension.

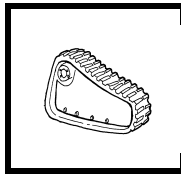

Recommend to the owner that all necessary corrections be made before the machine is returned to service.

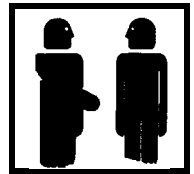

21. Inspect for loose or broken parts or connections.

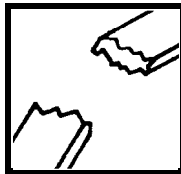

**CALIFORNIA  
PROPOSITION 65 WARNING**

Diesel engine exhaust and some of its constituents are known to the State of California to cause cancer, birth defects and other reproductive harm.

## SAFETY INSTRUCTIONS



### Safety Alert Symbol

This symbol with a warning statement means:  
“Warning, be alert! Your safety is involved!”  
Carefully read the message that follows.



## WARNING

Instructions are necessary before operating or servicing machine. Read and understand the Operation & Maintenance Manual, Operator's Handbook and signs (decals) on machine. Follow warnings and instructions in the manuals when making repairs, adjustments or servicing. Check for correct function after adjustments, repairs or service. Untrained operators and failure to follow instructions can cause injury or death.

W-2003-0903



## WARNING

Warnings on the machine and in the manuals are for your safety. Failure to obey warnings can cause injury or death.

W-2044-1285

## IMPORTANT

This notice identifies procedures which must be followed to avoid damage to the machine.

I-2019-0284

The following publications provide information on the safe use and maintenance of the Bobcat machine and attachments:

- The Delivery Report is used to assure that complete instructions have been given to the new owner and that the machine is in safe operating condition.
- The Operation & Maintenance Manual delivered with the machine or attachment contains operating information as well as routine maintenance and service procedures. It is a part of the machine and can be stored in a container provided on the machine. Replacement Operation & Maintenance Manuals can be ordered from your Bobcat dealer.
- Machine signs (decals) instruct on the safe operation and care of your Bobcat machine or attachment. The signs and their locations are shown in the Operation & Maintenance Manual. Replacement signs are available from your Bobcat dealer.
- An Operator's Handbook fastened to the operator cab. It's brief instructions are convenient to the operator. The handbook is available from your dealer in an English edition or one of many other languages. See your Bobcat dealer for more information on translated versions.
- The AEM Safety Manual delivered with the machine gives general safety information.
- The Service Manual and Parts Manual are available from your dealer for use by mechanics to do shop-type service and repair work.
- The Skid-Steer Loader Operator Training Course is available through your local dealer or at [www.training.bobcat.com](http://www.training.bobcat.com) or [www.bobcat.com](http://www.bobcat.com). This course is intended to provide rules and practices of correct operation of the Skid-Steer Loader. The course is available in English and Spanish versions.
- Service Safety Training Courses are available from your Bobcat dealer or at [www.training.bobcat.com](http://www.training.bobcat.com) or [www.bobcat.com](http://www.bobcat.com). They provide information for safe and correct service procedures.
- The Skid-Steer Loader Safety Video is available from your Bobcat dealer or at [www.training.bobcat.com](http://www.training.bobcat.com) or [www.bobcat.com](http://www.bobcat.com).

SI SSL-0206 SM

## SAFETY INSTRUCTIONS (CONT'D)

The dealer and owner/operator review the recommended uses of the product when delivered. If the owner/operator will be using the machine for a different application(s) he or she must ask the dealer for recommendations on the new use.



# Call Before You Dig

**1-888-258-0808**

When you call, you will be directed to a location in your state/city for information about buried lines (telephone, cable TV, water, sewer, gas, etc.)

## SAFETY INSTRUCTIONS (CONT'D)

### Fire Prevention

The machine and attachments have components that are at high temperature under normal operating conditions. The primary source of high temperatures is the engine and exhaust system. The electrical system, if damaged or incorrectly maintained, can be a source of arcs or sparks.

Flammable debris (leaves, straw, etc.) must be removed regularly. If flammable debris is allowed to accumulate, it will increase fire hazard. Clean often to avoid this accumulation. Flammable debris in the engine compartment is a potential hazard.

The spark arrestor muffler is designed to control the emission of hot particles from the engine and exhaust system, but the muffler and the exhaust gases are still hot.

- Do not use the machine where exhaust, arcs, sparks or hot components can contact flammable material, explosive dust or gases.
- The operator cab, engine compartment, and engine cooling system must be inspected every day and cleaned if necessary to prevent fire hazard and overheating.
- Check all electrical wiring and connections for damage. Keep the battery terminals clean and tight. Repair or replace any damaged part.
- Check fuel and hydraulic tubes, hoses and fittings for damage and leakage. Never use open flame or bare skin to check for leaks. Tighten or replace any parts that show leakage. Always clean fluid spills. Do not use gasoline or diesel fuel for cleaning parts. Use commercial nonflammable solvents.
- Do not use ether or starting fluids on any engine which has glow plugs. These starting aids can cause explosion and injure you or bystanders.
- Always clean the machine, disconnect the battery, and disconnect the wiring from the controllers before welding. Cover rubber hoses, battery and all other flammable parts. Keep a fire extinguisher near the machine when welding. Have good ventilation when grinding or welding painted parts. Wear a dust mask when grinding painted parts. Toxic dust or gas can be produced.
- Stop the engine and let it cool before adding fuel. **NO SMOKING!**

- Use the procedure in the Operation & Maintenance Manual for connecting the battery and for jump starting.
- Use the procedure in the Operation & Maintenance Manual for cleaning the spark arrestor muffler (if equipped).

Figure 1

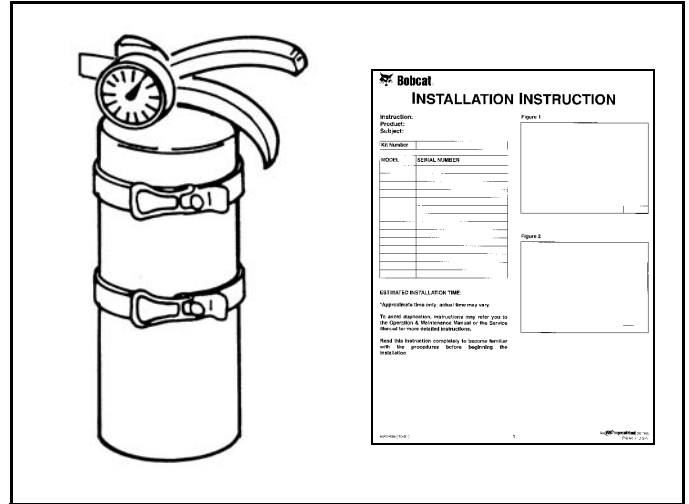

- Know where fire extinguishers and first aid kits are located and how to use them. Fire extinguishers are available from your Bobcat dealer [Figure 1].

## SERIAL NUMBER LOCATIONS

Always use the serial number of the loader when requesting service information or when ordering parts. Early or later models (identification made by serial number) may use different parts, or it may be necessary to use a different procedure in doing a specific service operation.

### Loader Serial Number

Figure 2

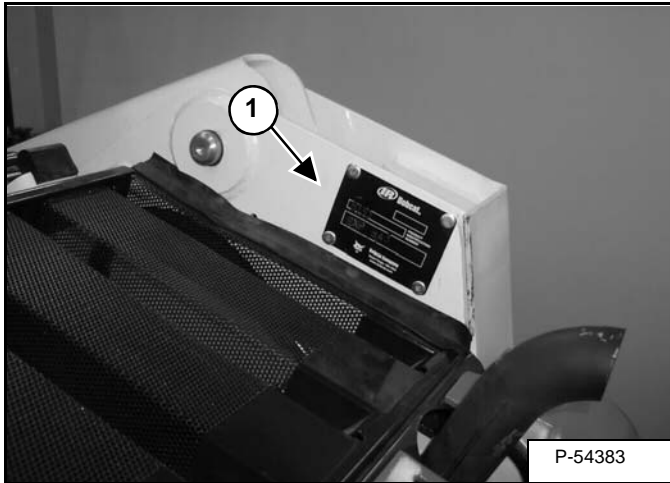

The loader serial number plate is located on the outside of the loader frame [Figure 2].

Explanation of loader Serial Number:

XXXX	XXXXX
Model 1.-Model/ Engine Combination	Model 2.-Production Sequence (Series)

1. The four digit Model/Engine Combination Module number identifies the model number and engine combination.
2. The five digit Production Sequence Number identifies the order which the loader is produced.

### Engine Serial Number

Figure 3

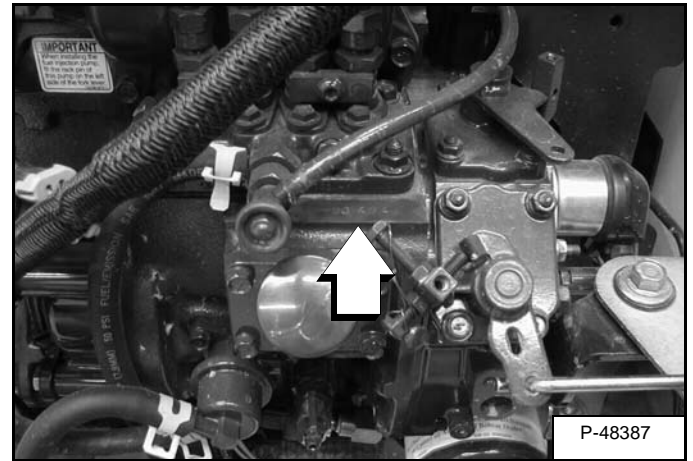

The engine serial number is in the location shown [Figure 3].

## DELIVERY REPORT

Figure 4

The diagram shows a form layout for a 'DELIVERY REPORT'. The form is enclosed in a rectangular border. At the top right, there is a header box labeled 'DELIVERY REPORT'. Below this, the form is divided into two main columns. The left column contains a section with a black header labeled 'WARNING' and several lines of text below it. The right column contains a large area with many horizontal lines, representing text input. At the bottom of the form, there is a small box on the right side containing the text 'B-16315'.

The Delivery Report must be filled out by the dealer and signed by the owner or operator when the Bobcat loader is delivered. An explanation of the form must be given to the owner. Make sure it is filled out completely **[Figure 4]**.

# LOADER IDENTIFICATION

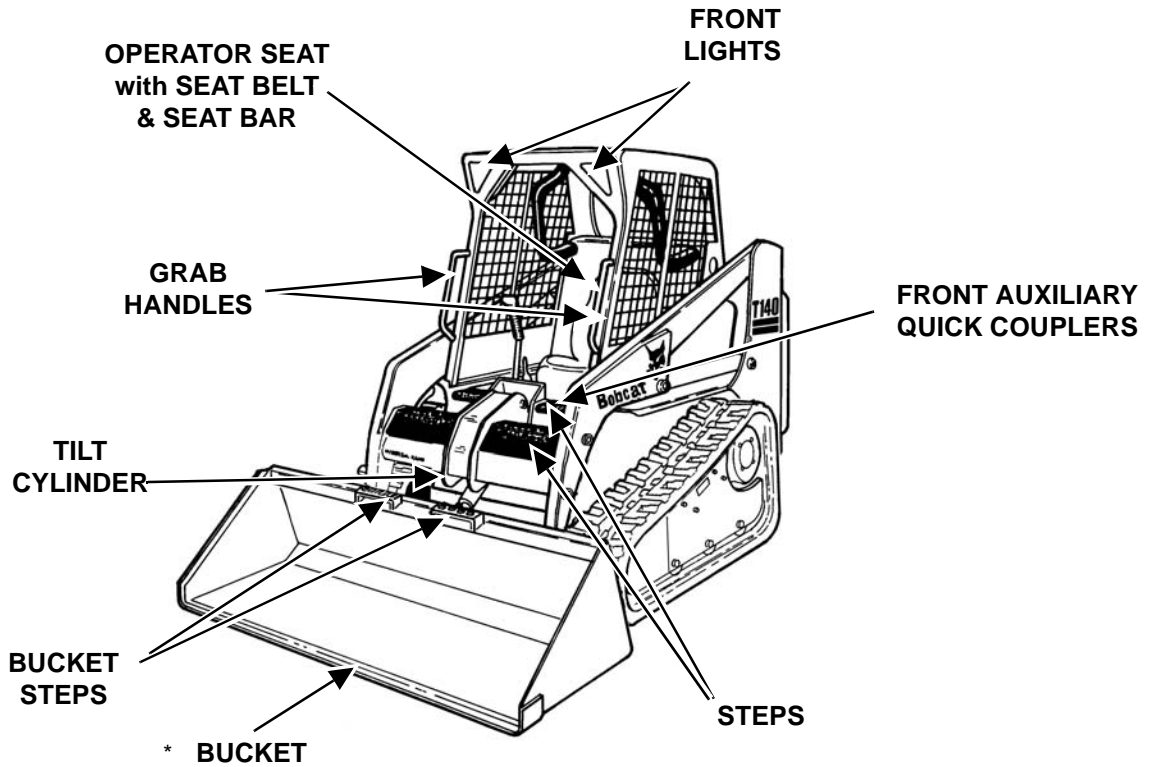

B-22239

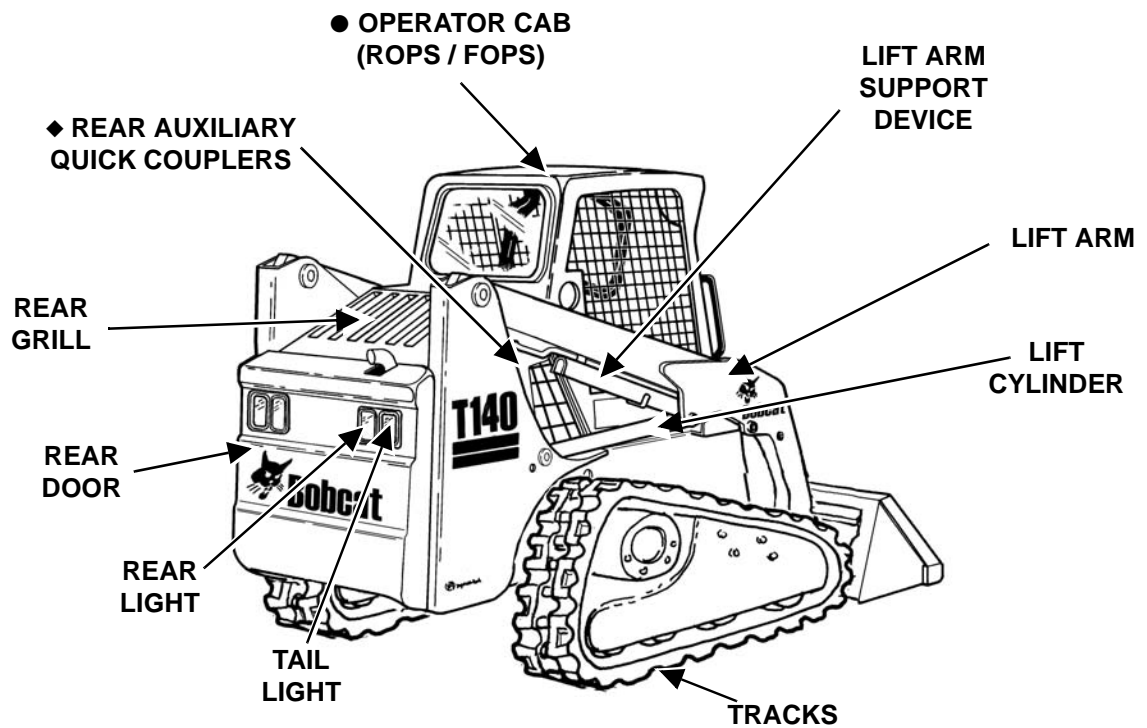

B-24240

◆ Optional or Field Accessory (Not Standard Equipment)

\* Bucket - Several different buckets and other attachments are available for this machine.

● ROPS, FOPS - Roll Over Protective Structure, per SAE / ISO 3471, and Falling Object Protective Structure per ISO 3449, Level I. Level II is available.

## SAFETY AND MAINTENANCE

AIR CLEANER SERVICE .....	10-80-1
Checking .....	10-80-1
Replacing Filter Element(s) .....	10-80-2
BOB-TACH™ .....	10-140-1
Inspection And Maintenance .....	10-140-1
ENGINE COOLING SYSTEM .....	10-90-1
Cleaning The Cooling System .....	10-90-1
Checking The Coolant Level .....	10-90-2
Replacing The Coolant .....	10-90-3
ENGINE LUBRICATION SYSTEM .....	10-110-1
Checking Engine Oil .....	10-110-1
Oil Chart .....	10-110-1
Replacing Oil And Filter .....	10-110-1
FAN GEARBOX .....	10-130-1
Checking And Maintaining .....	10-130-1
FUEL SYSTEM .....	10-100-1
Filling The Fuel Tank .....	10-100-1
Fuel Filter .....	10-100-2
Fuel Specifications .....	10-100-1
Removing Air From The Fuel System .....	10-100-2
HYDRAULIC/HYDROSTATIC SYSTEM .....	10-120-1
Breather Cap .....	10-120-4
Checking And Adding Fluid .....	10-120-1
Replacing Hydraulic Fluid .....	10-120-3
Replacing Hydraulic/Hydrostatic Filter .....	10-120-1
Replacing Hydrostatic Motor Case Drain Filter(s) .....	10-120-2
LIFT ARM SUPPORT DEVICE .....	10-20-1
Installing Lift Arm Support Device .....	10-20-1
Removing The Lift Arm Support Device .....	10-20-2
LIFTING AND BLOCKING THE LOADER .....	10-10-1
Procedure .....	10-10-1

**Continued On Next Page**

## **SAFETY AND MAINTENANCE (CONT'D)**

LUBRICATION OF THE BOBCAT LOADER.....	10-150-1
Procedure .....	10-150-1
OPERATOR CAB .....	10-30-1
Description .....	10-30-1
Emergency Exit .....	10-30-3
Lowering The Operator Cab .....	10-30-2
Raising The Operator Cab.....	10-30-1
POWER BOB-TACH™ .....	10-141-1
Inspection And Maintenance .....	10-141-1
REMOTE START.....	10-60-1
Procedure .....	10-60-1
SERVICE SCHEDULE .....	10-70-1
Chart .....	10-70-1
SPARK ARRESTOR MUFFLER .....	10-160-1
Servicing .....	10-160-1
TOWING THE LOADER .....	10-50-1
Procedure .....	10-50-1
TRANSPORTING THE BOBCAT LOADER .....	10-40-1
Procedure .....	10-40-1

**TIGHTEN ALL HARDWARE PER SIZE TO GRADE 5 TORQUE (SEE STANDARD TORQUE SPECIFICATIONS FOR BOLTS, SECTION SPEC-01) UNLESS OTHERWISE SPECIFIED.**

## LIFTING AND BLOCKING THE LOADER

### Procedure

Figure 10-10-1

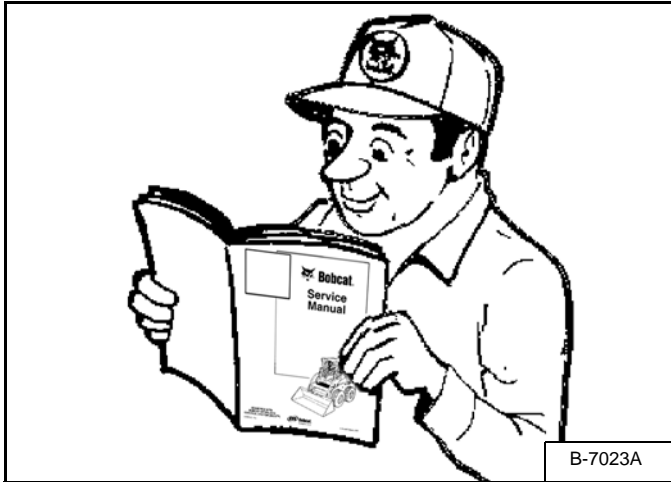

## WARNING

Instructions are necessary before operating or servicing machine. Read and understand the Operation & Maintenance Manual, Handbook and signs (decals) on machine. Follow warnings and instructions in the manuals when making repairs, adjustments or servicing. Check for correct function after adjustments, repairs or service. Untrained operators and failure to follow instructions can cause injury or death.

W-2003-0199

Always park the loader on a level surface.

## WARNING

Put jack stands under the front axles and rear corners of the frame before running the engine for service. Failure to use jack stands can allow the machine to fall or move and cause injury or death.

W-2017-0286

Figure 10-10-2



Put floor jack under the rear of the loader.

Lift the rear of the loader and install jack stands [Figure 10-10-2].

Figure 10-10-3

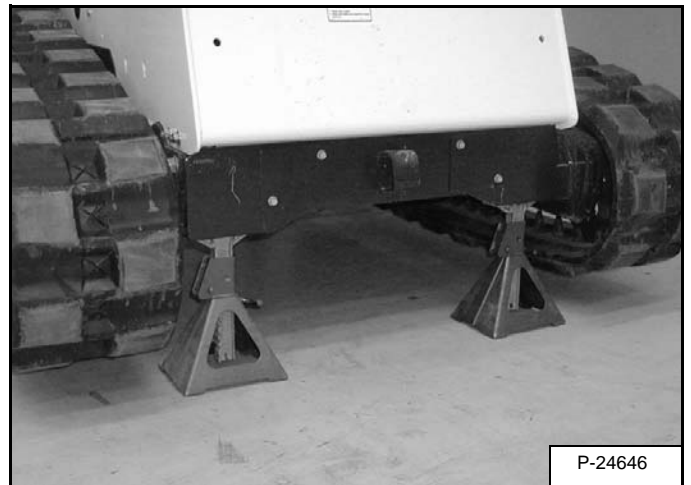

Put the floor jack under the front of the loader [Figure 10-10-3].

Lift the front of the loader and put jack stands under the axle tubes [Figure 10-10-3].

**NOTE:** Make sure the jack stands do not touch the tires. Make sure tires clear floor or any obstacles.

## LIFT ARM SUPPORT DEVICE

### Installing Lift Arm Support Device

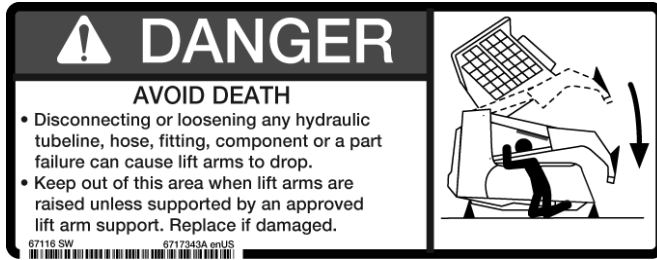

Never work on a machine with the lift arms up unless the lift arms are secured by an approved lift arm support device. Failure to use an approved lift arm support device can allow the lift arms or attachment to fall and cause injury or death.

W-2059-0598



Service lift arm support device if damaged or if parts are missing. Using a damaged lift arm support or with missing parts can cause lift arms to drop causing injury or death.

W-2271-1197

Figure 10-20-1

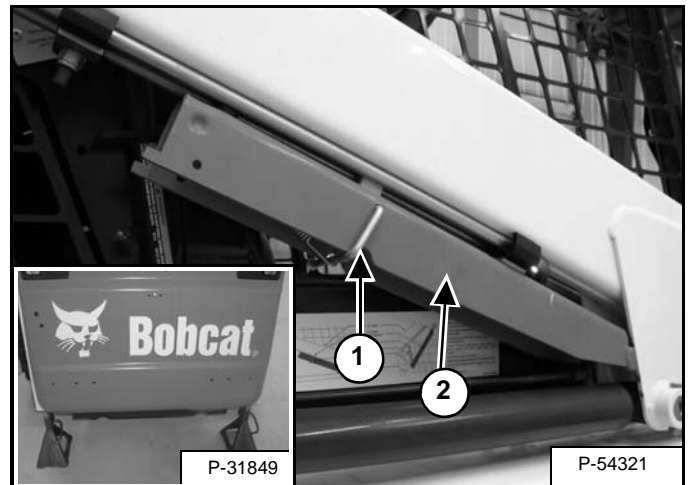

Put jack stands under the rear corners of the loader frame (Inset) [Figure 10-20-1].

Disconnect the spring from the lift arm support device retaining pin (Item 1). Support the lift arm support device (Item 2) [Figure 10-20-1] with your hand and remove the retaining pin.

Figure 10-20-2

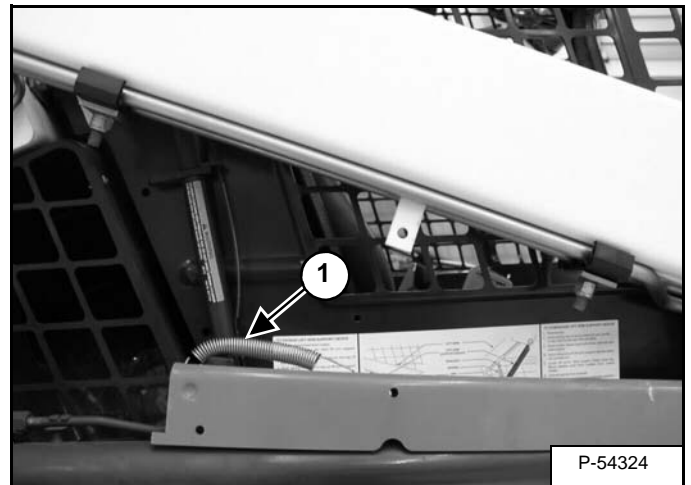

Lower the lift arm support device on top of the lift cylinder. Hook the free end of the spring (Item 1) [Figure 10-20-2] to the lift arm support device so there will be no interference with the support device engagement.

With the operator in the seat, seat belt fastened and seat bar lowered, start the engine.

## LIFT ARM SUPPORT DEVICE (CONT'D)

### Installing Lift Arm Support Device (Cont'd)

Figure 10-20-3

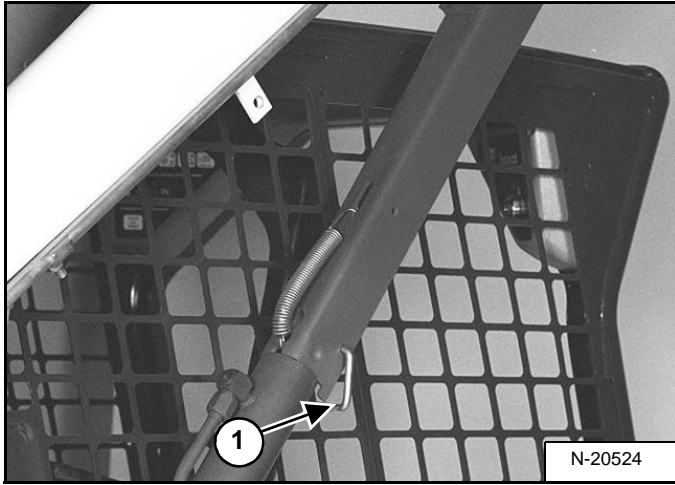

Raise the lift arms, until the lift arm support device drops onto the lift cylinder rod [Figure 10-20-3].

Lower the lift arms slowly until the support device is held between the lift arm and the lift cylinder. Stop the engine. Raise the seat bar and move pedals until both pedals lock.

Install pin (Item 1) [Figure 10-20-3] into the rear of the lift arm support device below the cylinder rod.

### Removing The Lift Arm Support Device

Figure 10-20-4

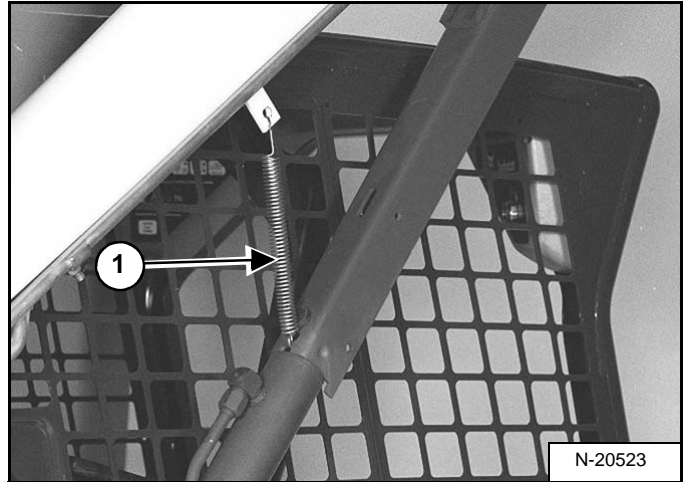

Remove the pin from the lift arm support device.

Connect the spring (Item 1) [Figure 10-20-4] from the lift arm support device to the bracket below the lift arms.

With the operator in the seat, seat belt fastened and seat bar lowered, start the engine.

Raise the lift arms a small amount and the spring will lift the support device off the lift cylinder rod. Lower the lift arms. Stop the engine.

Raise the seat bar and move pedals until all pedals lock.

Disconnect the spring from the bracket.

Figure 10-20-5

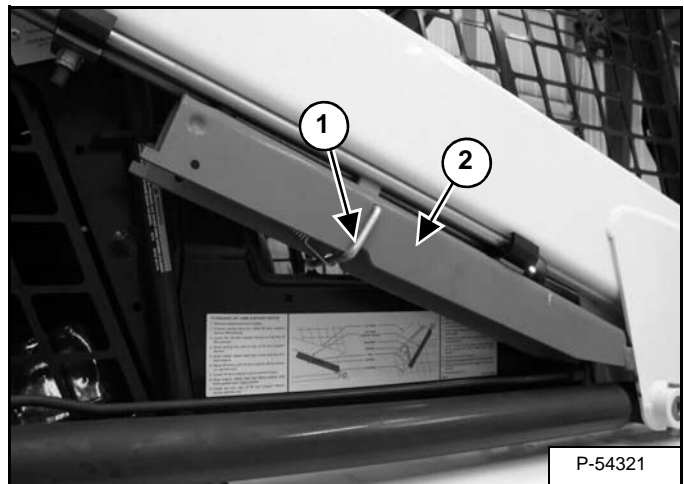

Raise the support device into storage position and insert pin (Item 1) through lift arm support device (Item 2) [Figure 10-20-5] and bracket. Connect spring to pin.

Remove jack stands.

## OPERATOR CAB

### Description

The Bobcat loader has an operator cab (ROPS and FOPS) as standard equipment to protect the operator from rollover and falling objects. Check with your dealer if the operator cab has been damaged. The seat belt must be worn for roll over protection.

ROPS/FOPS - Roll Over Protective Structure per SAE J1040 and ISO 3471, and Falling Object Protective Structure per SAE J1043 and ISO 3449, Level I. Level II is available.

Level I - Protection from falling bricks, small concrete blocks, and hand tools encountered in operations such as highway maintenance, landscaping, and other construction site services.

Level II - Protection from falling trees, rocks; for machines involved in site clearing, overhead demolition or forestry.

### Raising The Operator Cab

Always stop the engine before raising or lowering the cab.

Stop the loader on a level surface. Lower the lift arms. If the lift arms must be up while raising the operator cab, install the lift arm support device. (See Installing Lift Arm Support Device on Page 10-20-1.)

Figure 10-30-1



Install jack stands under the rear of the loader frame [Figure 10-30-1].

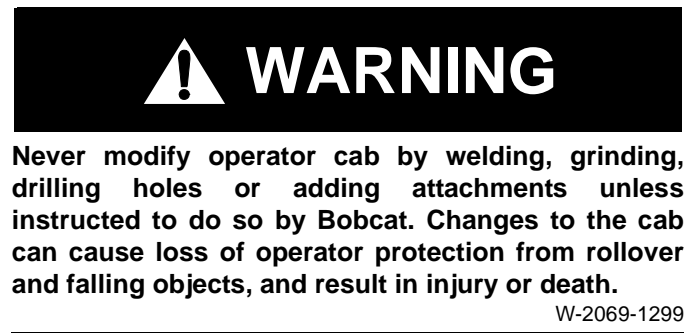



## OPERATOR CAB (CONT'D)

### Emergency Exit

Figure 10-30-6



The front opening on the operator cab and rear window provide exits.

#### Rear Window (If Equipped)

Pull on the tag on the top of the rear window to remove the rubber cord [Figure 10-30-6].

Figure 10-30-7



Push the rear window out of the rear of the operator cab.

Exit through the rear of the operator cab [Figure 10-30-7].

Figure 10-30-8

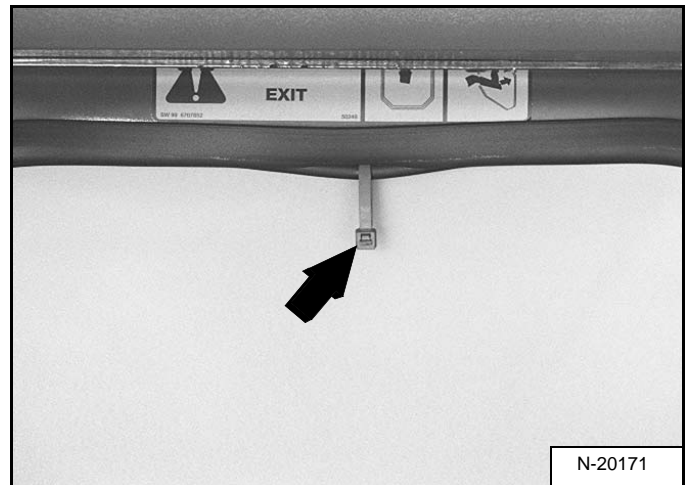

#### Front Door (If Equipped)

**NOTE:** When an Operator Cab Enclosure Kit is installed, the window of the front door can be used as an emergency exit. [Figure 10-30-8]

Pull the plastic loop at the top of the window in the front door to remove the rubber cord [Figure 10-30-8].

Figure 10-30-9

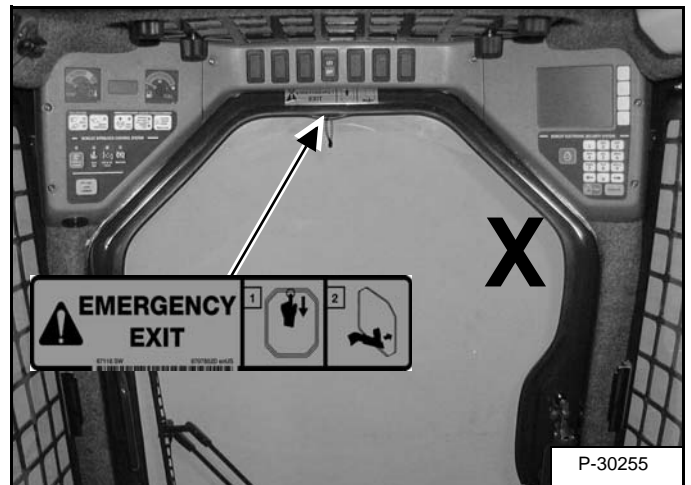

Push the window out with your foot [Figure 10-30-9] at any corner of the window.

Exit through the front door.

## TRANSPORTING THE BOBCAT LOADER

### Procedure



Adequately designed ramps of sufficient strength are needed to support the weight of the machine when loading onto a transport vehicle. Wood ramps can break and cause personal injury.

W-2058-0494

Figure 10-40-1

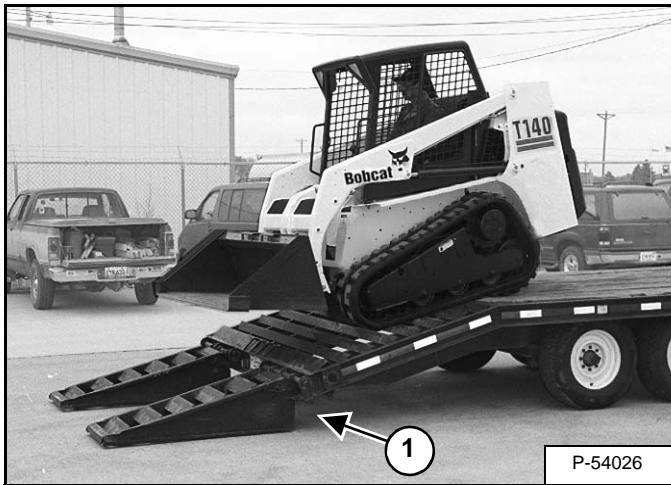

Be sure the transport and towing vehicles are of adequate size and capacity (See LOADER SPECIFICATIONS (T140) on Page SPEC-10-1.)

A loader with an empty bucket or no attachment must be loaded backward onto the transport vehicle [Figure 10-40-1].

The rear of the trailer must be blocked or supported (Item 1) [Figure 10-40-1] when loading or unloading the loader to prevent the front end of the trailer from raising up.

Figure 10-40-2

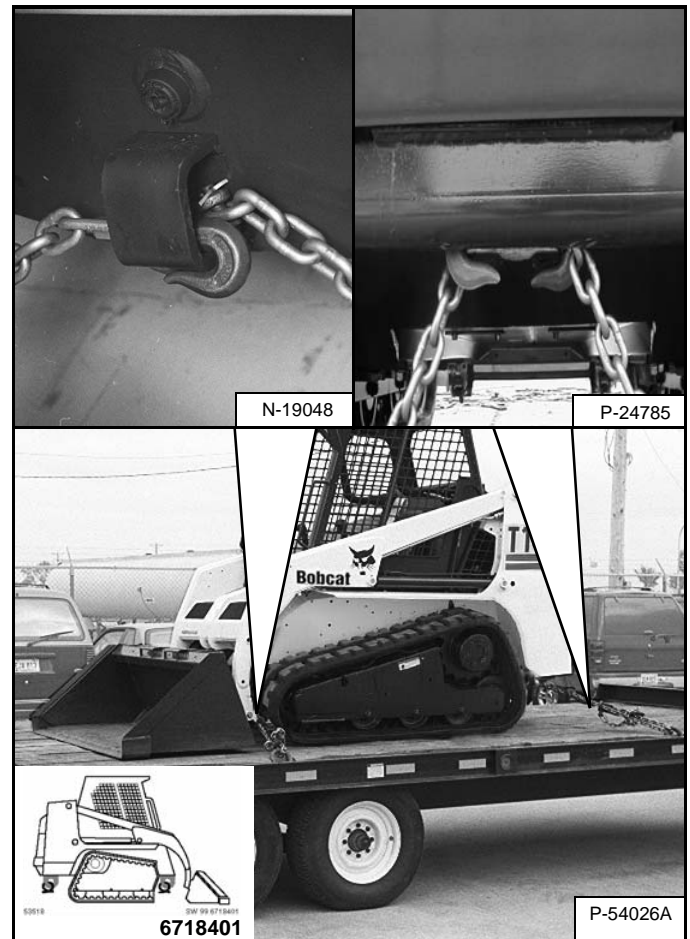

Use the following procedure to fasten the Bobcat loader to the transport vehicle to prevent the loader from moving during sudden stops or when going up or down slopes [Figure 10-40-2].

- Lower the bucket or attachment to the floor.
- Stop the engine.
- Engage the parking brake.
- Install chains at the front and rear loader tie down positions (Inset) [Figure 10-40-2].
- Fasten each end of the chain to the transport vehicle.

## TOWING THE LOADER

### Procedure

Because of the design of the loader, there is not a recommended towing procedure.

- The loader can be lifted onto a transport vehicle.
- The loader can be skidded a short distance to move for service (EXAMPLE: Move onto a transport vehicle.) without damage to the hydrostatic system. (The tires/tracks will not turn.) There might be slight wear to the tires/tracks when the loader is skidded.

The towing chain (or cable) must be rated at 1 & 1/2 times the weight of the loader(See LOADER SPECIFICATIONS (T140) on Page SPEC-10-1.)

## REMOTE START

### Procedure

Figure 10-60-1



The tool listed will be needed to do the following procedure:

#### MEL1563: Remote Start Tool Kit

The remote start (Item 1) [Figure 10-60-1] is required when the operator cab is in the raised position for service and the service technician needs to turn the key switch on or start the engine. Example: adjusting the steering linkage.

Figure 10-60-2

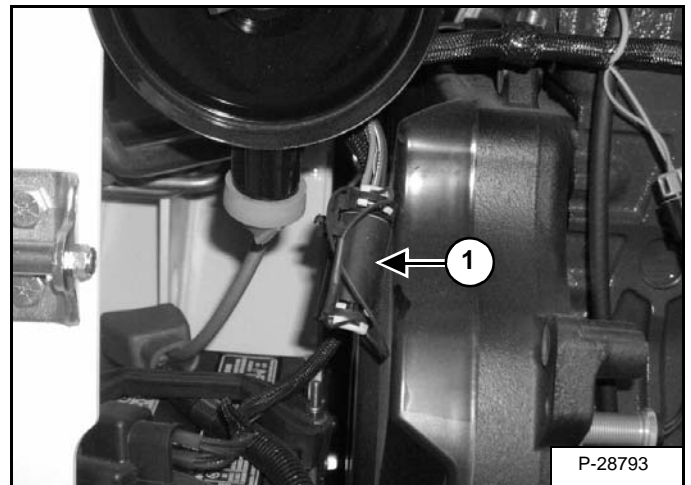
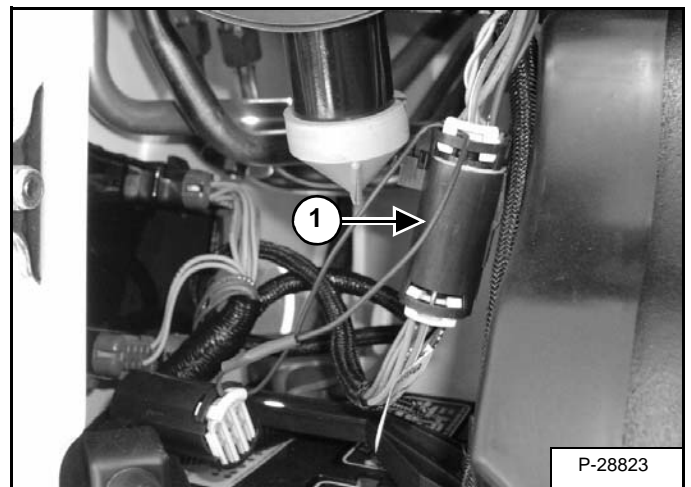

Figure 10-60-3



Lift and block the loader. (See Procedure on Page 10-10-1.)

Raise the lift arms (if required by the procedure) and install an approved lift arm support device. (See Installing Lift Arm Support Device on Page 10-20-1.)

Raise the operator cab (if required by the procedure). (See Raising The Operator Cab on Page 10-30-1.)

Open the rear door of the loader.

Remove the plug (Item 1) [Figure 10-60-2] /or disconnect the attachment control harness (Item 1) [Figure 10-60-3] if connected.

## REMOTE START (CONT'D)

### Procedure (Cont'd)

Figure 10-60-4

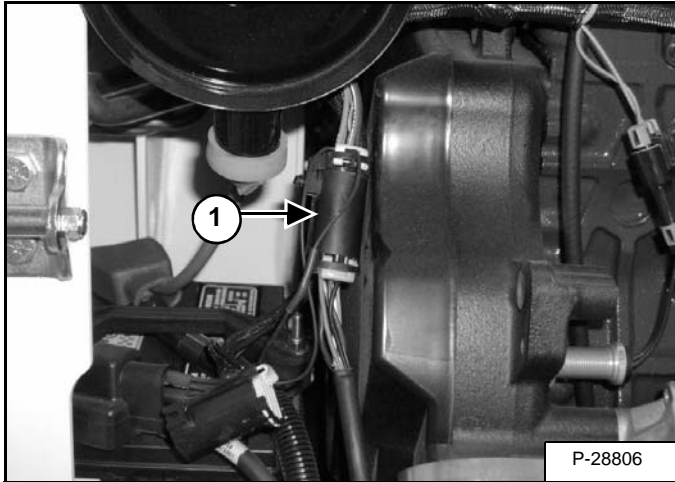

Connect the remote start tool to the engine harness connector (Item 1) [Figure 10-60-4].

**NOTE:** The key switch on the right-hand side operator panel must be in the off position or the Remote Start Kit will not operate.

**! WARNING**

- USE TRACTION LOCK OVERRIDE SWITCH FOR SERVICE WORK W/SEAT BAR RAISED.
- TRACTION LOCK IS ENGAGED WHEN LIGHT IS OFF. CHECK THAT WHEELS ARE CLEAR.
- TRACTION LOCK IS DISENGAGED WHEN LIGHT IS ON.
- SEE SERVICE MANUAL FOR MORE INSTRUCTION. FAILURE TO OBEY WARNING CAN CAUSE INJURY OR DEATH.

53690 SW 99 6719575



### AVOID INJURY OR DEATH

With the 7-pin connector plugged into the loader and Remote Start Key Switch in the OFF position, the loader can still be started from the operator panel inside the cab. Placing the key switch of the remote start tool in the run position disconnects the operator panel key switch from the start circuit. If the service technician will be working the engine area it is important to remove the operator panel keys.

W-2357-0899

Figure 10-60-5

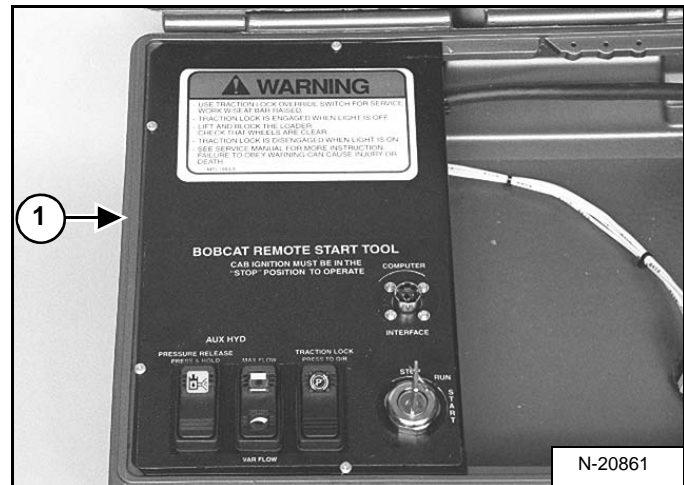

The remote start tool (Item 1) [Figure 10-60-5] has three rocker switches.

## REMOTE START (CONT'D)

### Procedure (Cont'd)

Figure 10-60-6

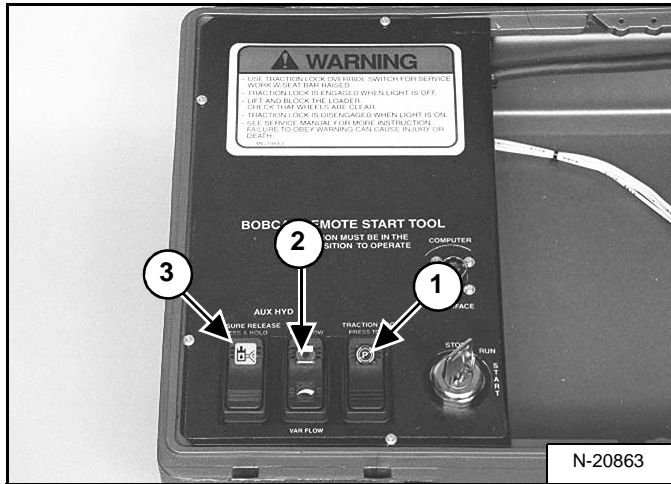

The traction lock switch (Item 1) [Figure 10-60-6] is used to turn traction lock on or off. Push the switch to the override position. The switch will illuminate to indicate traction lock **OVERRIDE**, in this position the wheels are able to turn.

The maximum flow/variable flow switch (Item 2) [Figure 10-60-6] is used to activate the auxiliary hydraulics. Pressing the switch once will activate variable flow. Pressing the switch again will activate maximum flow. The switch will illuminate to indicate which flow rate is active. Pressing the switch a third time will turn the flow OFF. The switch is used when checking pressures and flow rate.

Figure 10-60-7

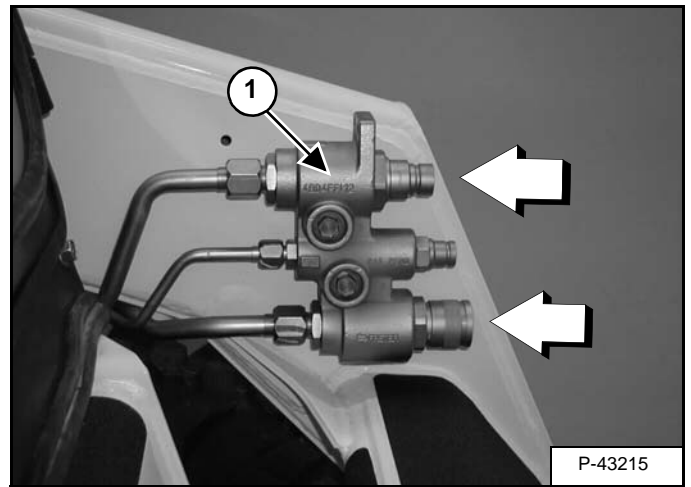

The loader is equipped with the front auxiliary coupler block (Item 1) [Figure 10-60-7], push the couplers towards the block and hold for five seconds to release the front auxiliary pressure.

To release the rear auxiliary coupler pressure and/or right hand front auxiliaries, use the pressure release button (Item 3) [Figure 10-60-6] on the remote start tool. Hold the button down for three seconds while the engine is running. The engine will shut off, the rear auxiliaries and the front right hand auxiliaries will relieve the pressure.



**Suggest:**

**If the above button click is invalid.**

**Please download this document**

**first, and then click the above link**

**to download the complete manual.**

**Thank you so much for reading**

## SERVICE SCHEDULE

### Chart

Maintenance work must be done at regular intervals. Failure to do so will result in excessive wear and early failures. The service schedule is a guide for correct maintenance of the Bobcat loader

 <b>WARNING</b>	<p>Instructions are necessary before operating or servicing machine. Read and understand the Operation &amp; Maintenance Manual, Operator's Handbook and signs (decals) on machine. Follow warnings and instructions in the manuals when making repairs, adjustments or servicing. Check for correct function after adjustments, repairs or service. Untrained operators and failure to follow instructions can cause injury or death.</p> <p style="text-align: right;">W-2003-0903</p>
--	--

SERVICE SCHEDULE		HOURS					
ITEM	SERVICE REQUIRED	8-10	50	100	■ 250	■ 500	■ 1000
Engine Oil	Check the oil level and add as needed. Do not overfill.						
Engine Air Filter and Air System	Check display panel. Service only when required. Check for leaks and damaged components.						
Engine Cooling System	Clean debris from oil cooler, radiator & grill. Check coolant level COLD and add premixed coolant as needed.						
Fuel Filter	Remove the trapped water.						
Lift Arms, Cylinders, Bob-Tach™ Pivot Pins and Wedges	Lubricate with multi-purpose lithium based grease.						
Seat Bar, Control Interlocks, Seat Belt, Seat Belt Retractors	Check the condition of seat belt. Clean or replace seat belt retractors as needed. Check the seat bar and control interlocks for correct operation. Clean dirt and debris from moving parts.						
Bobcat Interlock Control Systems (BICS)	Check that four BICS indicator lights and functions are activated. See details in this Manual.						
Safety Signs and Safety Treads	Check for damaged signs (decals) and safety treads. Replace any signs or safety treads that are damaged or worn.						
Operator Cab	Check the fastening bolts, washers and nuts. Check the condition of the cab.						
Indicators and Lights	Check for correct operation of all indicators and lights.						
Heater and A/C Filters (If Equipped)	Clean or replace filters as needed.						
Hydraulic Fluid, Hoses and Tubelines	Check fluid level and add as needed. Check for damage and leaks. Repair or replace as needed.						
Tracks	Check for damaged or worn tracks and correct tension.	☐					
Track Sprocket Bolts	Check torque. Tighten as needed. See procedure in this manual.		*				
Foot Pedals or Hand Controls, and Steering Levers	Check for correct operation. Repair or adjust as needed.						
Parking Brake	Check operation.						
Spark Arrestor Muffler	Clean the spark chamber.						
Battery	Check cables, connections and electrolyte level. Add distilled water as needed.						
Steering Lever Pivots	Grease fittings.						
Fuel Filter	Replace filter element.						
Engine/Hydro. Drive Belt	Check for wear or damage.		○				
Fan Drive Gearbox	Check gear lube level. Add as needed.						
Alternator Belt & Air Conditioner Belt (If Equipped)	Check condition and tension. Adjust or replace as needed.						
Bobcat Interlock Control System (BICS)	Check the function of the lift arm by-pass control.						
Engine Oil and Filter	Replace oil and filter. Use CD or better grade oil and Bobcat filter.		⚙				
Hydraulic/Hydrostatic Filter, Reservoir Breather Cap	Replace the hydrostatic filter, steering valve filter and the reservoir breather cap.		▼				
Hydraulic Reservoir	Replace the fluid.						
Case Drain Filters	Replace the filters.						
Hydrostatic Motor Carrier	Replace oil with high performance synthetic oil P/N 6682546.						
Coolant	Replace the coolant	Every 2 years					

■ Or every 12 months.

☐ Check every 8-10 hours for the first 50 hours, then 50 hour intervals thereafter.

\* Check after the first 50 hours of operation only.

○ Inspect the new belt after first 50 hours.

⚙ First oil and filter change must occur at 50 hours; 500 hours thereafter.

▼ Replace filter element after the first 50 hours and when the transmission warning light comes ON.

**<https://www.ebooklibonline.com>**

Hello dear friend!

Thank you very much for reading.

Enter the link into your browser.

The full manual is available for immediate download.

**<https://www.ebooklibonline.com>**