

**S205**  
**TURBO**

**S205**  
**TURBO**  
**HIGH FLOW**



**Bobcat®**

# Service Manual

S/N 528411001 & Above  
S/N 528511001 & Above

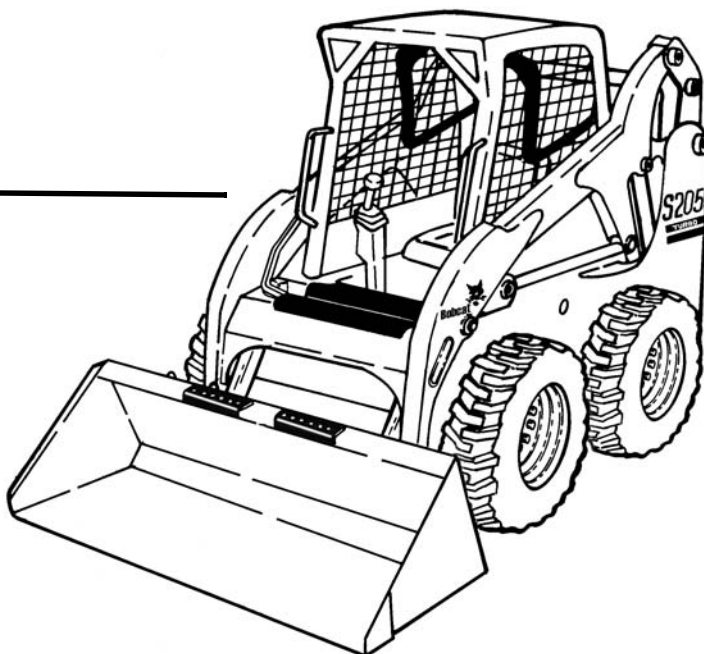

EQUIPPED WITH  
BOBCAT INTERLOCK  
CONTROL SYSTEM (BICS™)

6902917 (2-06)

**IR** Ingersoll Rand  
Compact Vehicle Technologies  
Printed in U.S.A.

© Bobcat Company 2006

# MAINTENANCE SAFETY



## WARNING

Instructions are necessary before operating or servicing machine. Read and understand the Operation & Maintenance Manual, Operator's Handbook and signs (decals) on machine. Follow warnings and instructions in the manuals when making repairs, adjustments or servicing. Check for correct function after adjustments, repairs or service. Untrained operators and failure to follow instructions can cause injury or death.

W-2003-0903



**Safety Alert Symbol:** This symbol with a warning statement, means: "Warning, be alert! Your safety is involved!" Carefully read the message that follows.

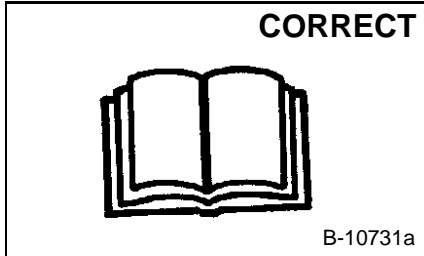

Never service the Bobcat Skid-Steer Loader without instructions.

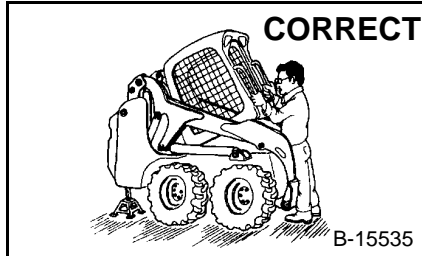

Use the correct procedure to lift or lower operator cab.

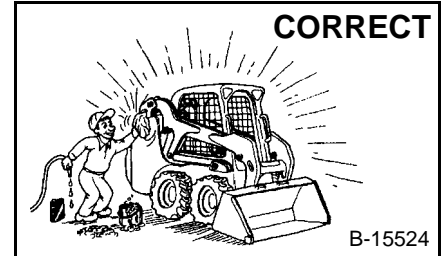

Cleaning and maintenance are required daily.

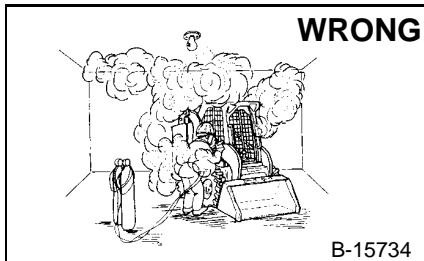

- Have good ventilation when welding or grinding painted parts.
- Wear dust mask when grinding painted parts. Toxic dust and gas can be produced.
- Avoid exhaust fume leaks which can kill without warning. Exhaust system must be tightly sealed.

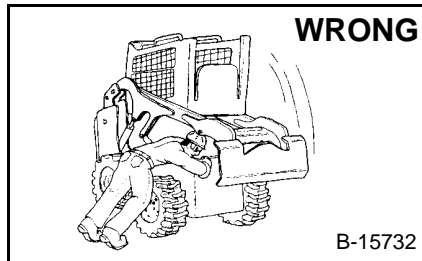

Disconnecting or loosening any hydraulic tubeline, hose, fitting, component or a part failure can cause lift arms to drop. Do not go under lift arms when raised unless supported by an approved lift arm support device. Replace it if damaged.

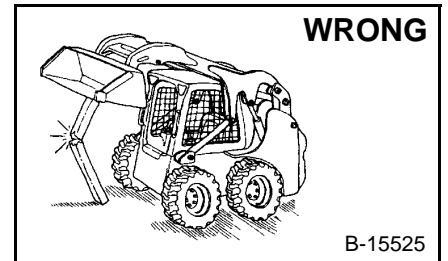

- Never work on loader with lift arms up unless lift arms are held by an approved lift arm support device. Replace if damaged.
- Never modify equipment or add attachments not approved by Bobcat Company.

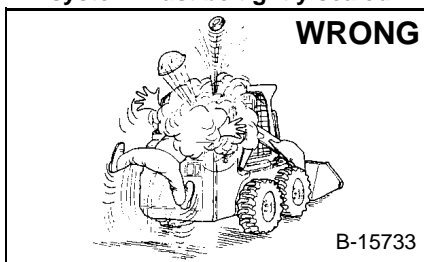

- Stop, cool and clean engine of flammable materials before checking fluids.
- Never service or adjust loader with the engine running unless instructed to do so in the manual.
- Avoid contact with leaking hydraulic fluid or diesel fuel under pressure. It can penetrate the skin or eyes.
- Never fill fuel tank with engine running, while smoking or when near open flame.

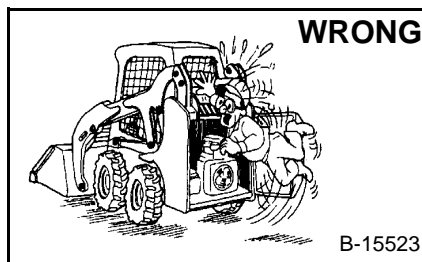

- Keep body, jewelry and clothing away from moving parts, electrical contact, hot parts and exhaust.
- Wear eye protection to guard from battery acid, compressed springs, fluids under pressure and flying debris when engines are running or tools are used. Use eye protection approved for type of welding.
- Keep rear door closed except for service. Close and latch door before operating the loader.

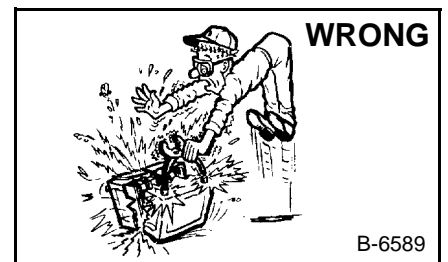

- Lead-acid batteries produce flammable and explosive gases.
- Keep arcs, sparks, flames and lighted tobacco away from batteries.
- Batteries contain acid which burns eyes or skin on contact. Wear protective clothing. If acid contacts body, flush well with water. For eye contact flush well and get immediate medical attention.

Maintenance procedures which are given in the Operation & Maintenance Manual can be performed by the owner/operator without any specific technical training. Maintenance procedures which are **not** in the Operation & Maintenance Manual must be performed **ONLY BY QUALIFIED BOBCAT SERVICE PERSONNEL**. Always use genuine Bobcat replacement parts. The Service Safety Training Course is available from your Bobcat dealer.

## ALPHABETICAL INDEX

ADVANCED CONTROL SYSTEM (ACS)	
SELECTABLE HAND/FOOT CONTROL .....	60-01
AIR CLEANER .....	70-01
AIR CLEANER SERVICE .....	10-01
AIR CONDITIONING SERVICE .....	80-01
AIR CONDITIONING SYSTEM FLOW .....	80-01
ALTERNATOR .....	60-01
BATTERY .....	60-01
BASIC TROUBLESHOOTING .....	80-01
BICS™ SYSTEM .....	60-01
BOBCAT CONTROLLER .....	60-01
BOB-TACH .....	10-01, 50-01
BRAKE .....	40-01
BUCKET POSITION VALVE .....	20-01
CALIBRATION .....	60-01
CHAINCASE .....	40-01
CHARGE PRESSURE .....	30-01
COMPONENTS .....	80-01
COMPRESSOR .....	80-01
CONDENSER .....	80-01
CONTROL HANDLE .....	50-01
CONTROL HANDLE (SJC) .....	50-01
CONTROL HANDLE (ADVANCED CONTROL SYSTEM) (ACS) SELECTABLE HAND/FOOT CONTROL....	50-01
CONTROL PANEL .....	50-01
CONTROL PANEL (SJC) .....	50-01
CONTROL PEDALS .....	50-01
CONTROL PEDALS (ACS) .....	50-01
CONTROLLER (SELECTABLE JOYSTICK CONTROL) (SJC) .....	50-01
CONVERSIONS .....	SPEC-01
COOLING FAN .....	70-01
CYLINDER (LIFT) .....	20-01
CYLINDER (POWER BOB-TACH) .....	20-01
CYLINDER (TILT) .....	20-01
DIAGNOSTICS SERVICE CODES .....	60-01
DRIVE BELT .....	30-01
DRIVE COMPONENTS .....	40-01
ELECTRICAL SYSTEM INFORMATION .....	60-01
ELECTRICAL/HYRAULIC CONTROLS REF. ....	60-01
ELECTRICAL/HYDRAULIC CONTROLS REFERENCE (SELECTABLE JOYSTICK CONTROL) (SJC) ....	60-01
ENGINE .....	70-01
ENGINE COMPONENTS AND TESTING .....	70-01
ENGINE COOLING SYSTEM .....	10-01
ENGINE LUBRICATION SYSTEM .....	10-01
ENGINE SPECIFICATIONS .....	SPEC-01
ENGINE SPEED CONTROL .....	70-01
EVAPORATOR .....	80-01
EVAPORATOR/HEATER UNIT .....	80-01
EXPANSION VALVE .....	80-01
FAN GEARBOX .....	10-01
FINAL DRIVE TRANSMISSION (CHAINCASE) ..	10-01
FLYWHEEL AND HOUSING .....	70-01
FLYWHEEL RPM SENSOR .....	60-01
FRONT AUXILIARY HYD. COUPLER BLOCK .....	20-01
FUEL SYSTEM .....	10-01
FUEL TANK .....	50-01
GENERAL AIR CONDITIONING SERVICE GUIDELINES .....	80-01
HEATER COIL .....	80-01
HEATER/AC FAN .....	80-01
HEATER VALVE .....	80-01
HIGH FLOW VALVE .....	20-01
HYDRAULIC CONNECTION SPECS. ....	SPEC-01
HYDRAULIC CONTROL VALVE .....	20-01
HYDRAULIC FILTER HOUSING .....	20-01
HYDRAULIC FLUID SPECIFICATIONS .....	SPEC-01
HYDRAULIC FLUID RESERVOIR .....	20-01
HYDRAULIC/HYDROSTATIC SYSTEM .....	10-01
HYDRAULIC PUMP .....	20-01
HYDRAULIC PUMP (HIGH FLOW) .....	20-01
HYDRAULIC PUMP (HIGH FLOW) (SJC) .....	20-01
HYDRAULIC PUMP (SJC) .....	20-01
HYDRAULIC SYSTEM INFORMATION .....	20-01
HYDROSTATIC MOTOR .....	30-01
HYDROSTATIC MOTOR CARRIER .....	30-01
HYDROSTATIC MOTOR CARRIER (SJC) .....	30-01
HYDROSTATIC PUMP .....	30-01
HYDROSTATIC SYSTEM INFORMATION .....	30-01
INSTRUMENT PANEL .....	60-01
LIFT ARMS .....	50-01
LIFT ARM BY-PASS CONTROL VALVE .....	20-01
LIFT ARM SUPPORT DEVICE .....	10-01
LIFTING AND BLOCKING THE LOADER .....	10-01
LIGHTS .....	60-01
LOADER SPECIFICATIONS .....	SPEC-01
LUBRICATING THE LOADER .....	10-01
MAIN RELIEF VALVE .....	20-01
MUFFLER .....	70-01
OIL COOLER .....	30-01
OPERATOR CAB .....	10-01, 50-01
OPERATOR SEAT .....	50-01
OPERATOR SEAT (SUSPENSION) .....	50-01
POWER BOB-TACH .....	10-01, 50-01
POWER BOB-TACH BLOCK .....	20-01
PRESSURE RELIEF VALVE .....	80-01
PRESSURE SWITCH .....	80-01

**<https://www.ebooklibonline.com>**

Hello dear friend!

Thank you very much for reading.

Enter the link into your browser.

The full manual is available for immediate download.

**<https://www.ebooklibonline.com>**

## ALPHABETICAL INDEX (CONT'D)

RADIATOR.....	70-01
REAR AUXILIARY DIVERTER VALVE .....	20-01
REAR DOOR .....	50-01
REAR GRILL .....	50-01
RECEIVER/DRIER .....	80-01
RECONDITIONING THE ENGINE-V2203-M-DI AND V2003-M-DI-T (TURBO) .....	70-01
REGULAR MAINTENANCE .....	80-01
REMOTE START .....	10-01
RPM SENSOR .....	70-01
SAFETY .....	80-01
SEAT BAR .....	50-01
SEAT BAR SENSOR .....	60-01
SERVICE PC (LAPTOP COMPUTER) .....	60-01
SERVICE SCHEDULE .....	10-01
SPARK ARRESTOR MUFFLER .....	10-01
SPEED SENSOR .....	60-01
STARTER .....	60-01
SYSTEM CHARGING AND RECLAMATION .....	80-01
SYSTEM TROUBLESHOOTING CHART .....	80-01
TEMPERATURE/PRESSURE .....	80-01
THERMOSTAT.....	80-01
TIRE MAINTENANCE .....	10-01
TORQUE SPECIFICATIONS FOR BOLTS ....	SPEC-01
TOWING THE LOADER .....	10-01
TRACTION LOCK.....	60-01
TRANSPORTING THE BOBCAT LOADER.....	10-01
TROUBLESHOOTING.....	70-01
TURBOCHARGER .....	70-01

# CONTENTS

FOREWORD.....	II
SAFETY INSTRUCTIONS .....	V
SERIAL NUMBER LOCATION .....	IX
DELIVERY REPORT.....	X
BOBCAT LOADER IDENTIFICATION.....	XI
SAFETY AND MAINTENANCE.....	10-01
HYDRAULIC SYSTEM .....	20-01
HYDROSTATIC SYSTEM.....	30-01
DRIVE SYSTEM .....	40-01
MAIN FRAME .....	50-01
ELECTRICAL SYSTEM .....	60-01
ENGINE SERVICE .....	70-01
HEATING, VENTILATION, AIR CONDITIONING .....	80-01
SPECIFICATIONS.....	SPEC-01

**SAFETY &  
MAINTENANCE**

**HYDRAULIC  
SYSTEM**

**HYDROSTATIC  
SYSTEM**

**DRIVE  
SYSTEM**

**MAIN FRAME**

**ELECTRICAL  
SYSTEM**

**ENGINE  
SERVICE**

**HVAC**

**SPECIFICATIONS**

# FOREWORD

This manual is for the Bobcat loader mechanic. It provides necessary servicing and adjustment procedures for the Bobcat loader and its component parts and systems. Refer to the Operation & Maintenance Manual for operating instructions, Starting procedure, daily checks, etc.

A general inspection of the following items must be made after the loader has had service or repair:

1. Check lift arm support device, replace if damaged. (Stored Position)

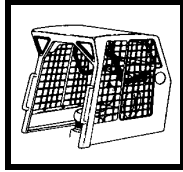

9. The parking brake must function correctly.



2. Check that ROPS mounting hardware is tightened and is Bobcat approved.

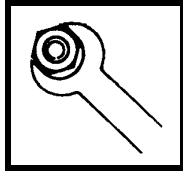

10. Enclosure door latches must open and close freely.

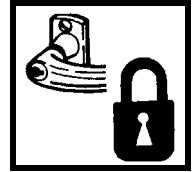

3. The seat belt must be correctly installed, functional and in good condition.

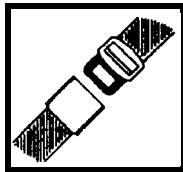

11. Bob-Tach wedges and linkages must function correctly and be in good condition.

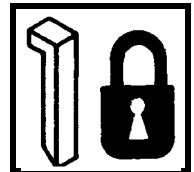

4. The seat bar must be correctly adjusted, clean and lubricated.

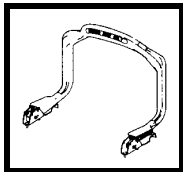

12. Safety treads must be in good condition.

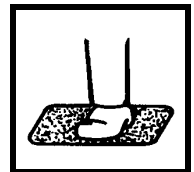

5. Check lift arm support device; replace if damaged.

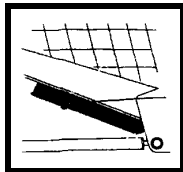

13. Check for correct function of indicator lamps (Optional on some models).

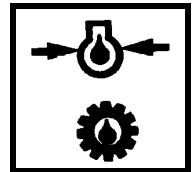

6. Machine signs must be legible and in the correct location.



14. Check hydraulic fluid level, engine oil level and fuel supply.

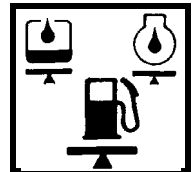

7. Steering levers and foot pedals must return to neutral.

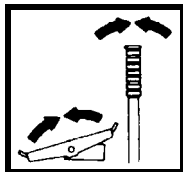

15. Inspect for fuel, oil or hydraulic fluid leaks.

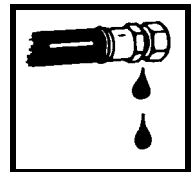

8. Check for correct function of the work lights



16. Lubricate the loader.



17. Check the condition of the battery and cables.



22. Operate the loader and check all functions.

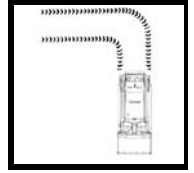

18. Inspect the air cleaner for damage or leaks. Check the condition of the element.

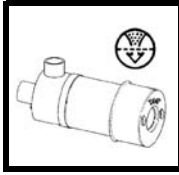

23. Check for any field modification not completed.



19. Check the electrical charging system.

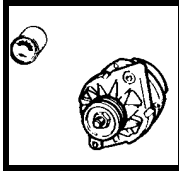

24. Check for correct function of the Bobcat Interlock Control System (BICST™) before the machine is returned to the customer.

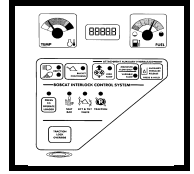

20. Check tires for wear and pressure.

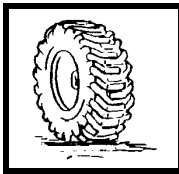

Recommend to the owner that all necessary corrections be made before the machine is returned to service.

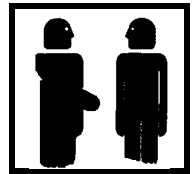

21. Inspect for loose or broken parts or connections.

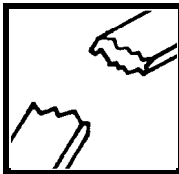

**CALIFORNIA  
PROPOSITION 65 WARNING**  
Diesel engine exhaust and some of its constituents are known to the State of California to cause cancer, birth defects and other reproductive harm.

## SAFETY INSTRUCTIONS



### Safety Alert Symbol

This symbol with a warning statement means:  
“Warning, be alert! Your safety is involved!”  
Carefully read the message that follows.



## WARNING

Instructions are necessary before operating or servicing machine. Read and understand the Operation & Maintenance Manual, Operator's Handbook and signs (decals) on machine. Follow warnings and instructions in the manuals when making repairs, adjustments or servicing. Check for correct function after adjustments, repairs or service. Untrained operators and failure to follow instructions can cause injury or death.

W-2003-0903



## WARNING

Warnings on the machine and in the manuals are for your safety. Failure to obey warnings can cause injury or death.

W-2044-1285

## IMPORTANT

This notice identifies procedures which must be followed to avoid damage to the machine.

I-2019-0284

The following publications provide information on the safe use and maintenance of the Bobcat machine and attachments:

- The Delivery Report is used to assure that complete instructions have been given to the new owner and that the machine is in safe operating condition.
- The Operation & Maintenance Manual delivered with the machine or attachment contains operating information as well as routine maintenance and service procedures. It is a part of the machine and can be stored in a container provided on the machine. Replacement Operation & Maintenance Manuals can be ordered from your Bobcat dealer.
- Machine signs (decals) instruct on the safe operation and care of your Bobcat machine or attachment. The signs and their locations are shown in the Operation & Maintenance Manual. Replacement signs are available from your Bobcat dealer.
- An Operator's Handbook fastened to the operator cab. It's brief instructions are convenient to the operator. The handbook is available from your dealer in an English edition or one of many other languages. See your Bobcat dealer for more information on translated versions.
- The AEM Safety Manual delivered with the machine gives general safety information.
- The Service Manual and Parts Manual are available from your dealer for use by mechanics to do shop-type service and repair work.
- The Skid-Steer Loader Operator Training Course is available through your local dealer or at [www.training.bobcat.com](http://www.training.bobcat.com) or [www.bobcat.com](http://www.bobcat.com). This course is intended to provide rules and practices of correct operation of the Skid-Steer Loader. The course is available in English and Spanish versions.
- Service Safety Training Courses are available from your Bobcat dealer or at [www.training.bobcat.com](http://www.training.bobcat.com) or [www.bobcat.com](http://www.bobcat.com). They provide information for safe and correct service procedures.
- The Skid-Steer Loader Safety Video is available from your Bobcat dealer or at [www.training.bobcat.com](http://www.training.bobcat.com) or [www.bobcat.com](http://www.bobcat.com).

SI SSL-0206 SM

**S205 Bobcat Loader  
Service Manual**

## SAFETY INSTRUCTIONS (CONT'D)

### Fire Prevention

The machine and attachments have components that are at high temperature under normal operating conditions. The primary source of high temperatures is the engine and exhaust system. The electrical system, if damaged or incorrectly maintained, can be a source of arcs or sparks.

Flammable debris (leaves, straw, etc.) must be removed regularly. If flammable debris is allowed to accumulate, it will increase fire hazard. Clean often to avoid this accumulation. Flammable debris in the engine compartment is a potential hazard.

The spark arrestor muffler is designed to control the emission of hot particles from the engine and exhaust system, but the muffler and the exhaust gases are still hot.

- Do not use the machine where exhaust, arcs, sparks or hot components can contact flammable material, explosive dust or gases.
- The operator cab, engine compartment, and engine cooling system must be inspected every day and cleaned if necessary to prevent fire hazard and overheating.
- Check all electrical wiring and connections for damage. Keep the battery terminals clean and tight. Repair or replace any damaged part.
- Check fuel and hydraulic tubes, hoses and fittings for damage and leakage. Never use open flame or bare skin to check for leaks. Tighten or replace any parts that show leakage. Always clean fluid spills. Do not use gasoline or diesel fuel for cleaning parts. Use commercial nonflammable solvents.
- Do not use ether or starting fluids on any engine which has glow plugs. These starting aids can cause explosion and injure you or bystanders.
- Always clean the machine, disconnect the battery, and disconnect the wiring from the controllers before welding. Cover rubber hoses, battery and all other flammable parts. Keep a fire extinguisher near the machine when welding. Have good ventilation when grinding or welding painted parts. Wear a dust mask when grinding painted parts. Toxic dust or gas can be produced.
- Stop the engine and let it cool before adding fuel. **NO SMOKING!**

- Use the procedure in the Operation & Maintenance Manual for connecting the battery and for jump starting.
- Use the procedure in the Operation & Maintenance Manual for cleaning the spark arrestor muffler (if equipped).

Figure 1

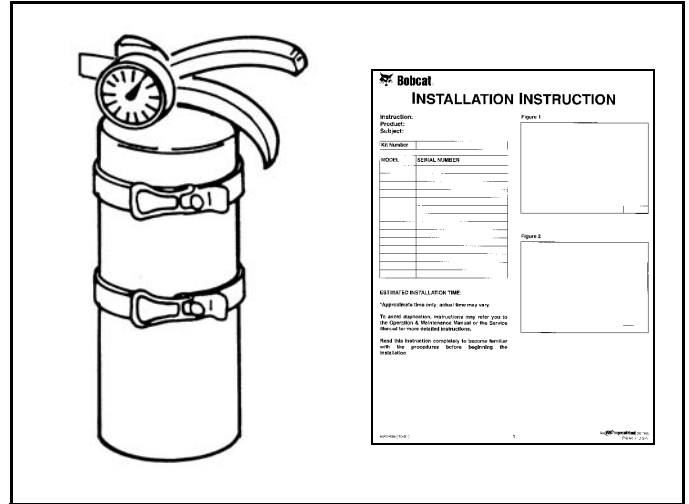

- Know where fire extinguishers and first aid kits are located and how to use them. Fire extinguishers are available from your Bobcat dealer [Figure 1].

## SERIAL NUMBER LOCATION

Always use the serial number of the loader when requesting service information or when ordering parts. Early or later models (identification made by serial number) may use different parts, or it may be necessary to use a different procedure in doing a specific service operation.

### Loader Serial Number

Figure 2



The loader serial number plate is located on the outside of the loader frame [Figure 2].

Explanation of loader Serial Number:

XXXX	XXXXX
Model 1.-Model/ Engine Combination	Model 2.-Production Sequence (Series)

1. The four digit Model/Engine Combination Module number identifies the model number and engine combination.
2. The five digit Production Sequence Number identifies the order which the loader is produced.

### Engine Serial Number

Figure 3

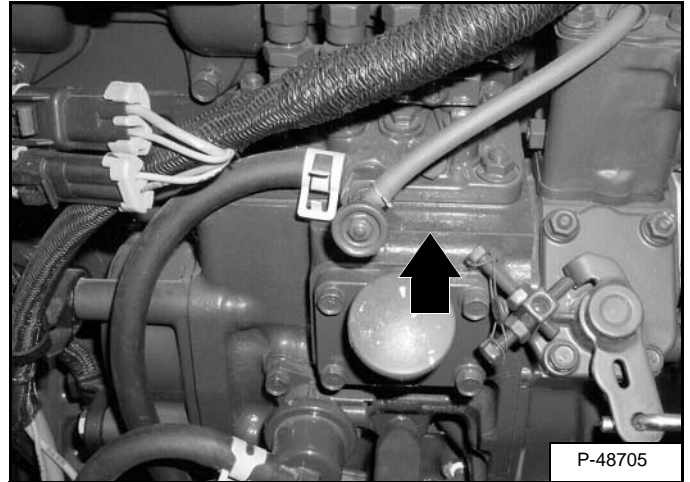

The engine serial number is in the location shown [Figure 3].

## DELIVERY REPORT

Figure 4

The diagram shows a form layout with the following sections:

- Top right: **DELIVERY REPORT** section with multiple lines for text.
- Top left: Section with multiple lines for text.
- Middle left: **WARNING** section with a black header and multiple lines for text.
- Middle right: Large section with many horizontal lines for text.
- Bottom left: Section with multiple lines for text.
- Bottom right: Small box containing the text **B-16315**.

The Delivery Report must be filled out by the dealer and signed by the owner or operator when the Bobcat loader is delivered. An explanation of the form must be given to the owner. Make sure it is filled out completely **[Figure 4]**.

## BOBCAT LOADER IDENTIFICATION

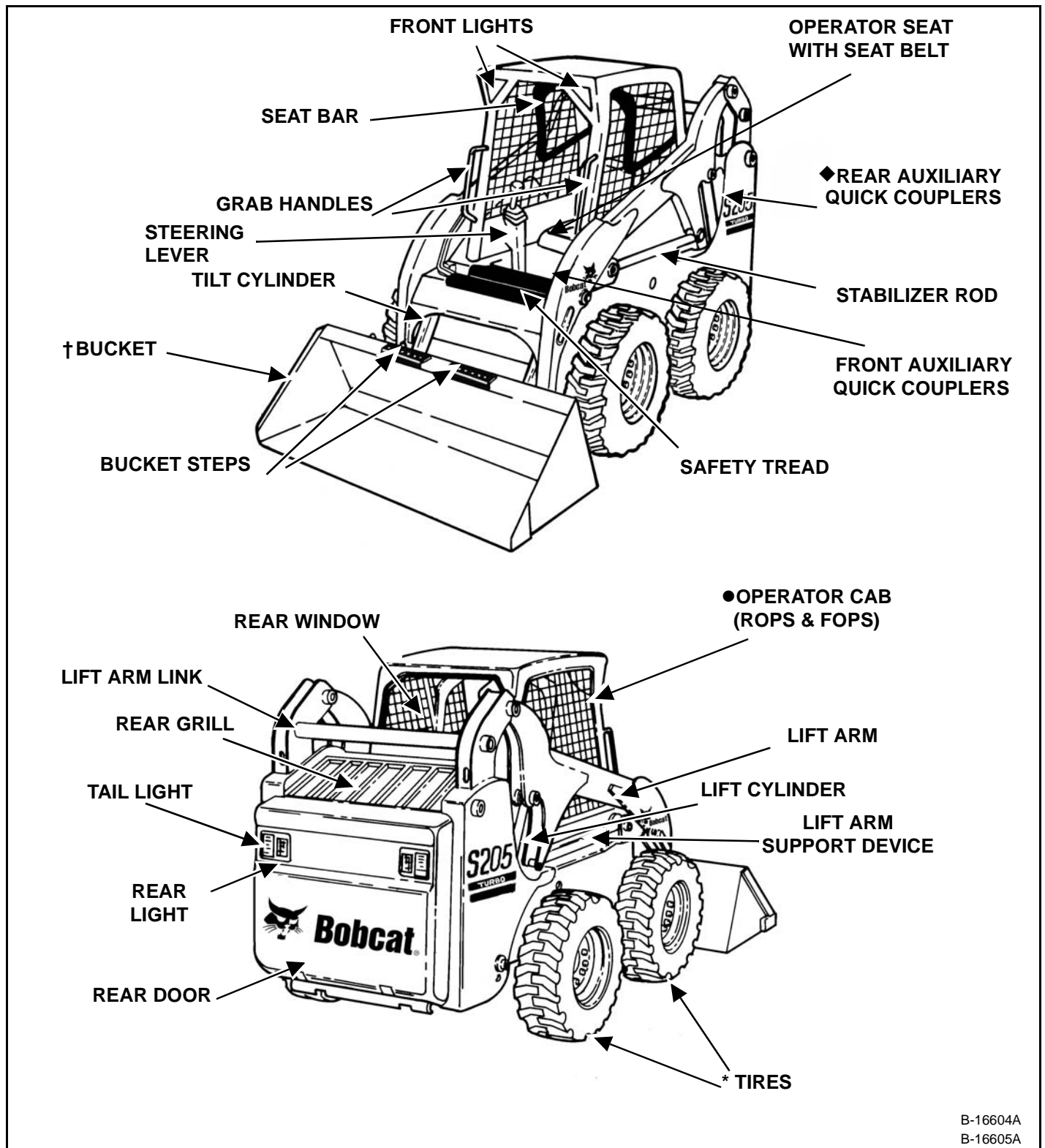

B-16604A  
B-16605A

◆ OPTIONAL OR FIELD ACCESSORY (Not Standard Equipment)

\* TIRES - The Bobcat loader is factory equipped with heavy duty flotation tires. See Specifications Section and your Bobcat dealer for available tires.

† BUCKET - Several different buckets and other attachments are available for the Bobcat loader.

● ROPS, FOPS - Roll Over Protective Structure, per SAE J1040 and ISO 3471, and Falling Object Protective Structure per SAEJ1043 and ISO 3449, Level I. Level II is available. The Bobcat loader is base-equipped with a standard operator cab as shown. Extra insulated cab is available as an option (Reduced noise level).

**SAFETY AND MAINTENANCE**

AIR CLEANER SERVICE . . . . . 10-80-1  
    Checking . . . . . 10-80-1  
    Replacing Filter Element(s) . . . . . 10-80-1

BOB-TACH . . . . . 10-150-1  
    Inspection And Maintenance . . . . . 10-150-1

ENGINE COOLING SYSTEM . . . . . 10-90-1  
    Checking The Coolant Level . . . . . 10-90-2  
    Cleaning The Cooling System . . . . . 10-90-1  
    Replacing the Coolant . . . . . 10-90-2

ENGINE LUBRICATION SYSTEM . . . . . 10-110-1  
    Checking Engine Oil . . . . . 10-110-1  
    Oil Chart. . . . . 10-110-1  
    Replacing Oil And Filter . . . . . 10-110-2

FAN GEARBOX. . . . . 10-140-1  
    Checking And Maintaining . . . . . 10-140-1

FINAL DRIVE TRANSMISSION (CHAINCASE) . . . . . 10-130-1  
    Checking And Adding Oil . . . . . 10-130-1  
    Removing Oil From The Chaincase. . . . . 10-130-1

FUEL SYSTEM . . . . . 10-100-1  
    Filling The Fuel Tank . . . . . 10-100-1  
    Fuel Filter. . . . . 10-100-2  
    Fuel Specifications. . . . . 10-100-1  
    Removing Air From The Fuel System . . . . . 10-100-2

HYDRAULIC/HYDROSTATIC SYSTEM . . . . . 10-120-1  
    Breather Cap . . . . . 10-120-3  
    Checking And Adding Fluid . . . . . 10-120-1  
    Replacing Hydraulic Fluid . . . . . 10-120-1  
    Replacing Hydraulic/Hydrostatic Filter. . . . . 10-120-1

LIFT ARM SUPPORT DEVICE . . . . . 10-20-1  
    Installing Lift Arm Support Device . . . . . 10-20-1  
    Removing Lift Arm Support Device . . . . . 10-20-2

LIFTING AND BLOCKING THE LOADER . . . . . 10-10-1  
    Procedure . . . . . 10-10-1

LUBRICATION OF THE BOBCAT LOADER. . . . . 10-160-1  
    Procedure . . . . . 10-160-1

**Continued On Next Page**

## SAFETY AND MAINTENANCE (CONT'D)

OPERATOR CAB .....	10-30-1
Description .....	10-30-1
Emergency Exit .....	10-30-3
Lowering The Operator Cab .....	10-30-2
Raising The Operator Cab .....	10-30-1
POWER BOB-TACH (OPTION) .....	10-151-1
Inspection And Maintenance .....	10-151-1
REMOTE START .....	10-60-1
Procedure .....	10-60-1
SERVICE SCHEDULE .....	10-70-1
Chart .....	10-70-1
SPARK ARRESTOR MUFFLER .....	10-180-1
Cleaning Procedure .....	10-180-1
TIRE MAINTENANCE .....	10-170-1
Mounting .....	10-170-1
Rotating .....	10-170-1
Wheel Nuts .....	10-170-1
TOWING THE LOADER .....	10-50-1
Procedure .....	10-50-1
TRANSPORTING THE BOBCAT LOADER .....	10-40-1
Procedure .....	10-40-1

**TIGHTEN ALL HARDWARE PER SIZE TO GRADE 5 TORQUE (SEE STANDARD TORQUE SPECIFICATIONS FOR BOLTS, SPEC SECTION) UNLESS OTHERWISE SPECIFIED.**

## LIFTING AND BLOCKING THE LOADER

Figure 10-10-1



### **WARNING**

Instructions are necessary before operating or servicing machine. Read and understand the Operation & Maintenance Manual, Operator's Handbook and signs (decals) on machine. Follow warnings and instructions in the manuals when making repairs, adjustments or servicing. Check for correct function after adjustments, repairs or service. Untrained operators and failure to follow instructions can cause injury or death.

W-2003-0903

#### Procedure

Always park the loader on a level surface.

### **WARNING**

Put jackstands under the front axles and rear corners of the frame before running the engine for service. Failure to use jackstands can allow the machine to fall or move and cause injury or death.

W-2017-0286

Figure 10-10-2



Put the floor jack under the front of the loader.

Lift the front of the loader and put jackstands under the axle tubes [Figure 10-10-2].

**NOTE:** Make sure the jackstands do not touch the tires. Make sure tires clear floor or any obstacles.

Figure 10-10-3



Put the floor jack under the rear of the loader [Figure 10-10-3].

Lift the rear of the loader and install jackstands [Figure 10-10-3].

## LIFT ARM SUPPORT DEVICE

### Installing Lift Arm Support Device

# ⚠ WARNING

Never work on a machine with the lift arms up unless the lift arms are secured by an approved lift arm support device. Failure to use an approved lift arm support device can allow the lift arms or attachment to fall and cause injury or death.

W-2059-0598

# ⚠ WARNING

Service lift arm support device if damaged or if parts are missing. Using a damaged lift arm support or with missing parts can cause lift arms to drop causing injury or death.

W-2271-1197

Figure 10-20-1

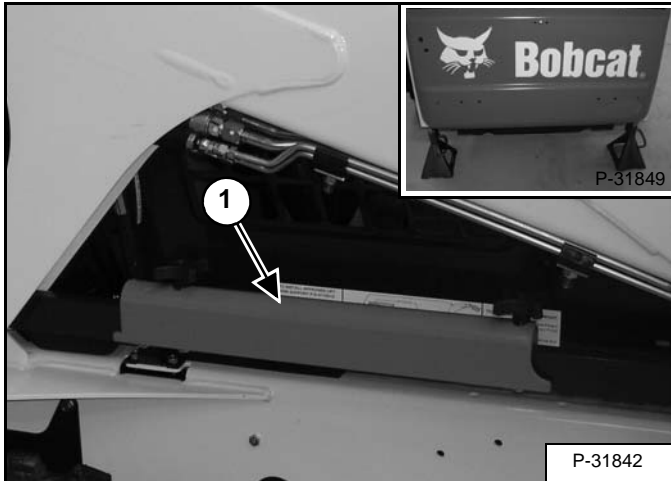

# ⚠ DANGER

## AVOID DEATH

- Disconnecting or loosening any hydraulic tubeline, hose, fitting, component or a part failure can cause lift arms to drop.
- Keep out of this area when lift arms are raised unless supported by an approved lift arm support. Replace if damaged.

67118 SW 8717343A enUS

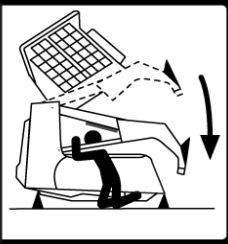

Put jackstands under the rear corners of the loader frame (Inset) [Figure 10-20-1].

Remove the lift arm support device (Item 1) [Figure 10-20-1] from storage position.

Figure 10-20-2

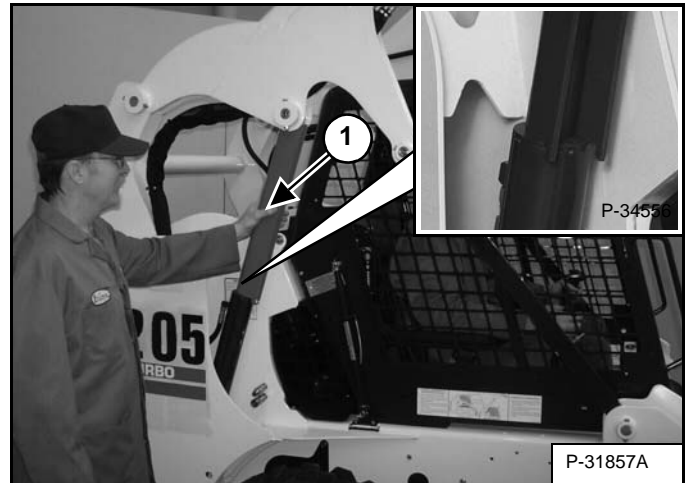

The operator must be in the operator's seat, with the seat belt fastened and seat bar lowered, until the lift arm support device is installed.

Start the engine, and raise the lift arms all the way up.

Have a second person install the lift arm support device (Item 1) [Figure 10-20-2] over the rod of one of the lift cylinders.

The lift arm support device must be tight against the cylinder rod. The tabs of the lift arm support device must be under the cylinder as shown (Inset) [Figure 10-20-2].

## LIFT ARM SUPPORT DEVICE (CONT'D)

### Installing Lift Arm Support Device (Cont'd)

Figure 10-20-3

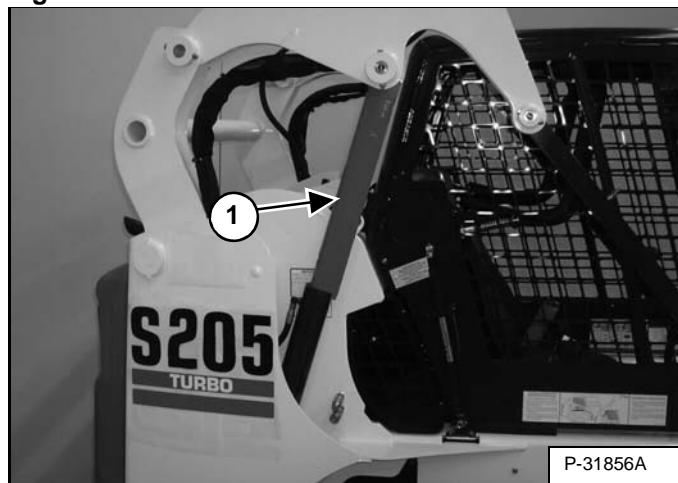

Lower the lift arms slowly until the lift arm support device (Item 1) [Figure 10-20-3] is held between the lift arms and lift cylinder .

### Removing Lift Arm Support Device

The operator must be in the operator's seat, with the seat belt fastened and seat bar lowered, until the lift arm support device is removed and the lift arms are lowered all the way.

Start the engine, raise the lift arms all the way up.

Have a second person remove the lift arm support device.

Lower the lift arms all the way and stop the engine.

Return the lift arm support device to storage position and secure with clamping knobs.

Remove the jackstands.

## OPERATOR CAB

### Description

The Bobcat loader has an operator cab (ROPS and FOPS) as standard equipment to protect the operator from rollover and falling objects. Check with your dealer if the operator cab has been damaged. The seat belt must be worn for roll over protection.

ROPS/FOPS - Roll Over Protective Structure per SAE J1040 and ISO 3471, and Falling Object Protective Structure per SAE J1043 and ISO 3449, Level I. Level II is available.

*Level I* - Protection from falling bricks, small concrete blocks, and hand tools encountered in operations such as highway maintenance, landscaping, and other construction site services.

*Level II* - Protection from falling trees, rocks; for machines involved in site clearing, overhead demolition or forestry.

## Raising The Operator Cab

Figure 10-30-1



Always stop the engine before raising or lowering the cab.

Stop the loader on a level surface. Lower the lift arms. If the lift arms must be up while raising the operator cab, install the lift arm support device. (See Installing Lift Arm Support Device on Page 10-20-1.)

Install jackstands under the rear of the loader frame [Figure 10-30-1].

Figure 10-30-2

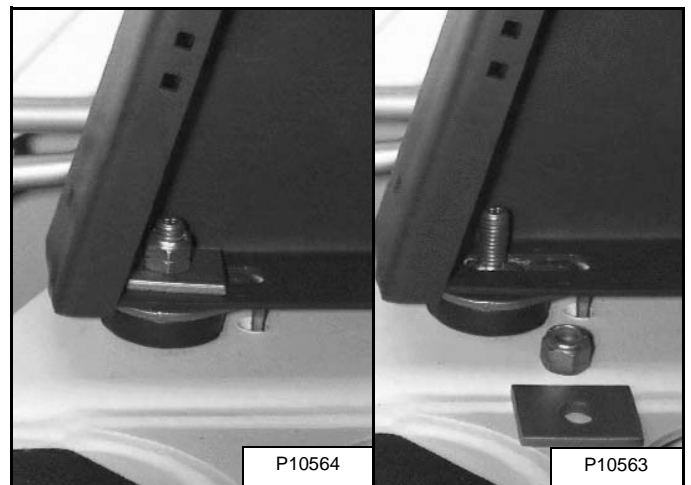

Remove the nut and plate (both sides) at the front corners of the operator cab [Figure 10-30-2].

## OPERATOR CAB (CONT'D)

### Raising The Operator Cab (Cont'd)

# ! WARNING

Never modify operator cab by welding, grinding, drilling holes or adding attachments unless instructed to do so by Bobcat. Changes to the cab can cause loss of operator protection from rollover and falling objects, and result in injury or death.

W-2069-1299

Figure 10-30-3



Lift on the grab handle and bottom of the operator cab slowly until the cab is all the way up and the latching mechanism engages [Figure 10-30-3].

*Advanced Hand Controls (AHC) and Advanced Control System (ACS)*

# ! WARNING



Unexpected loader, lift arm or attachment movement caused by cab contact with steering levers can cause serious injury or death.

BEFORE RAISING OR LOWERING CAB:

- Stop engine

52991

SW 98 6715944

## Lowering The Operator Cab

Figure 10-30-4

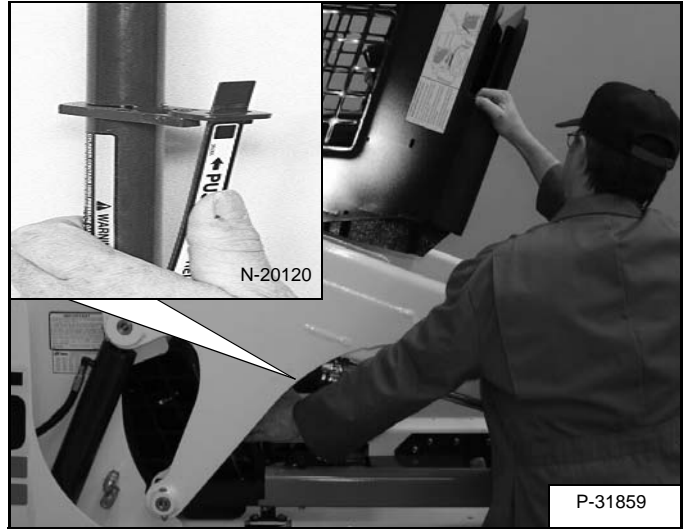

Always stop the engine before raising or lowering the cab.

**NOTE:** Make sure seat bar is fully raised or lowered when lowering the cab. Always use the grab handles to lower the cab.

Pull down on the bottom of the operator cab until it stops at the latching mechanism [Figure 10-30-4].

Release the latching mechanism (Inset) [Figure 10-30-4] and pull the cab all the way down.

Figure 10-30-5

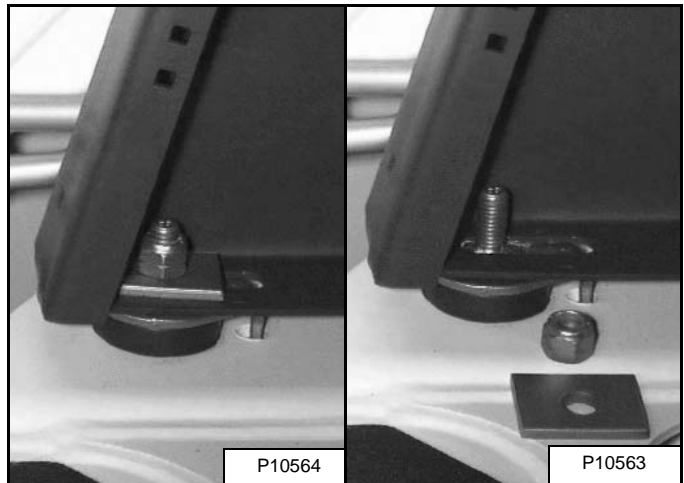

Install the plates and nuts [Figure 10-30-5] (both sides).

Tighten the nuts to 40-50 ft.-lb. (54-68 N•m) torque.

## OPERATOR CAB (CONT'D)

### Emergency Exit

Figure 10-30-6



The front opening on the operator cab and rear window provide exits.

#### Rear Window (If Equipped)

Pull on the tag on the top of the rear window to remove the rubber cord [Figure 10-30-6].

Figure 10-30-7

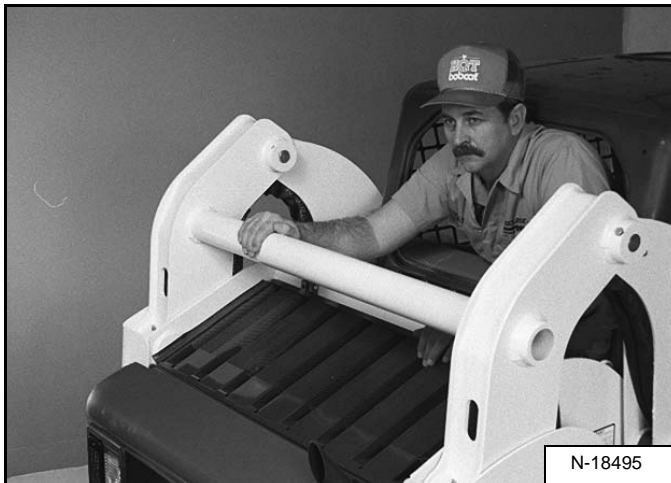

Push the rear window out of the rear of the operator cab.

Exit through the rear of the operator cab [Figure 10-30-7].

Figure 10-30-8

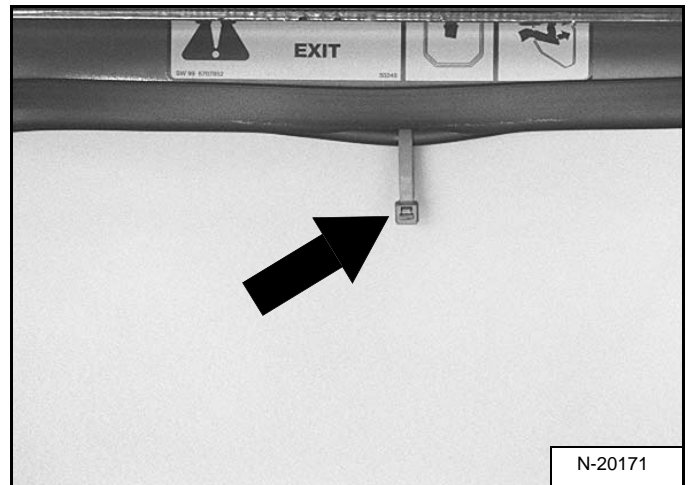

#### Front Door (If Equipped)

**NOTE:** When an Operator Cab Enclosure Kit is installed, the window of the front door can be used as an emergency exit. [Figure 10-30-8].

**NOTE:** If the loader has a Special Application Door Kit installed, the window of the front door is **NOT** an emergency exit.

Pull the plastic loop at the top of the window in the front door to remove the rubber cord [Figure 10-30-8].

Figure 10-30-9

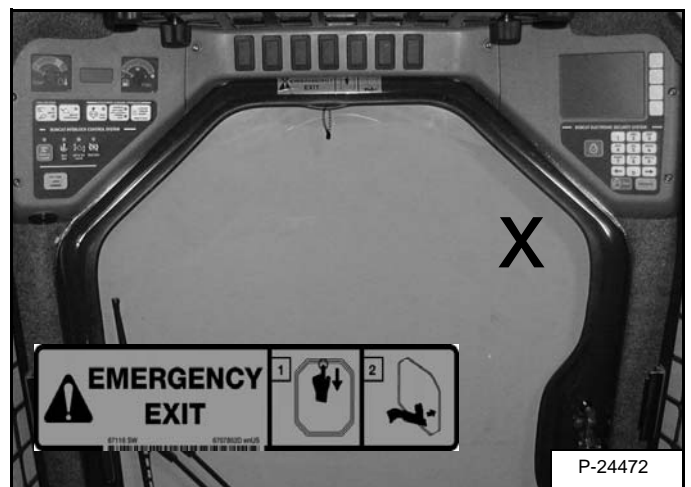

Push the window out with your foot [Figure 10-30-9] at any corner of the window.

Exit through the front door.

## TRANSPORTING THE BOBCAT LOADER

### Procedure



Adequately designed ramps of sufficient strength are needed to support the weight of the machine when loading onto a transport vehicle. Wood ramps can break and cause personal injury.

W-2058-0494

Figure 10-40-1

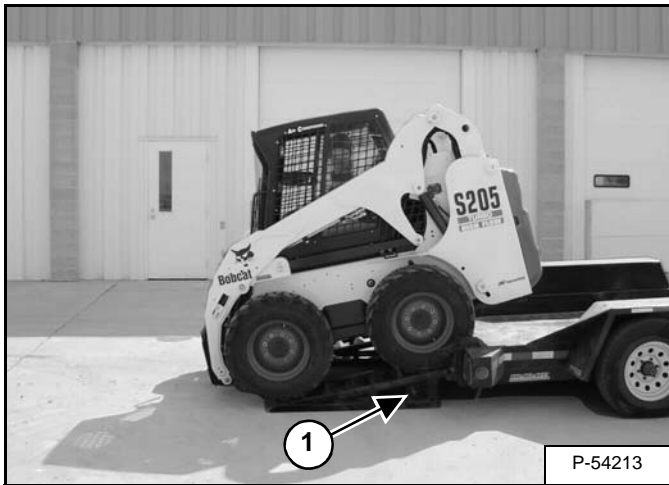

A loader with an empty bucket or no attachment must be loaded backward onto the transport vehicle [Figure 10-40-1].

Be sure the transport and towing vehicles are of adequate size and capacity (See LOADER SPECIFICATIONS on Page SPEC-10-1), for weight of loader.).

The rear of the trailer must be blocked or supported (Item 1)[Figure 10-40-1] when loading or unloading the loader to prevent the front end of the trailer from raising up.

Figure 10-40-2

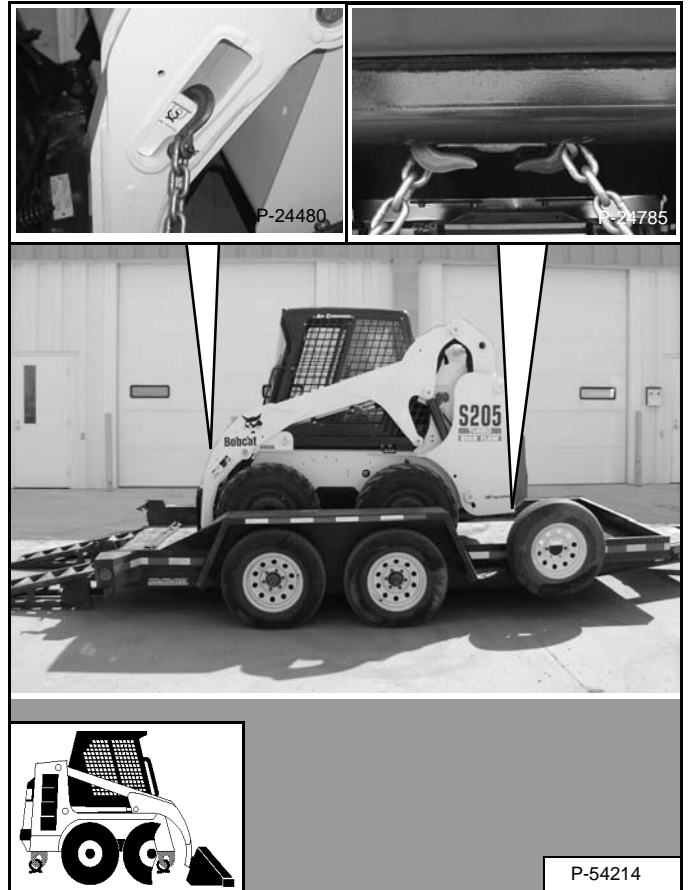

Use the following procedure to fasten the Bobcat loader to the transport vehicle to prevent the loader from moving during sudden stops or when going up or down slopes [Figure 10-40-2].

- Lower the bucket or attachment to the floor.
- Stop the engine.
- Engage the parking brake.
- Install chains at the front and rear loader tie down positions (Inset) [Figure 10-40-2].
- Fasten each end of the chain to the transport vehicle.

## TOWING THE LOADER

### Procedure

Because of the design of the loader, there is not a recommended towing procedure.

- The loader can be lifted onto a transport vehicle.
- The loader can be skidded a short distance to move for service (EXAMPLE: Move onto a transport vehicle.) without damage to the hydrostatic system. (The tires/tracks will not turn.) There might be slight wear to the tires/tracks when the loader is skidded.

The towing chain (or cable) must be rated at 1 & 1/2 times the weight of the loader (See LOADER SPECIFICATIONS on Page SPEC-10-1.)

## REMOTE START

### Procedure



#### AVOID INJURY OR DEATH

With the 7-pin connector plugged into the loader and Remote Start Key Switch in the OFF position, the loader can still be started from the operator panel inside the cab. Placing the key switch of the remote start tool in the run position disconnects the operator panel key switch from the start circuit. If the service technician will be working the engine area it is important to remove the operator panel keys.

W-2357-0899

Figure 10-60-1

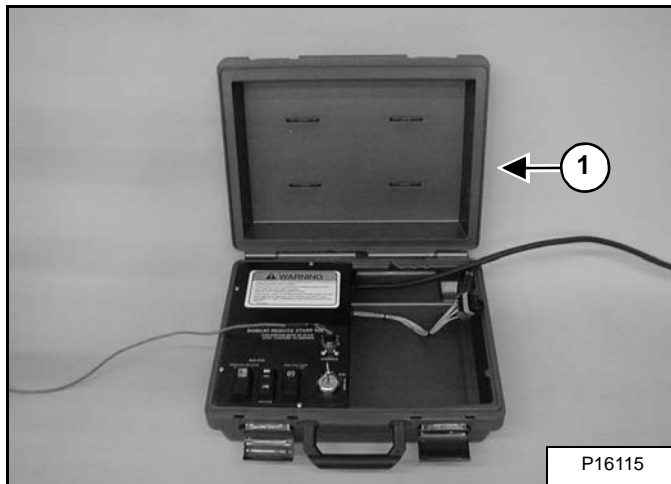

The tool listed will be need to do the following procedure:

MEL1563 - Remote Start Tool Kit

The remote start (Item 1) [Figure 10-60-1] is required when the operator cab is in the raised position for service and the service technician needs to turn the key switch on or start the engine. Example: Control Handle: linkage neutral adjustment.

Figure 10-60-2

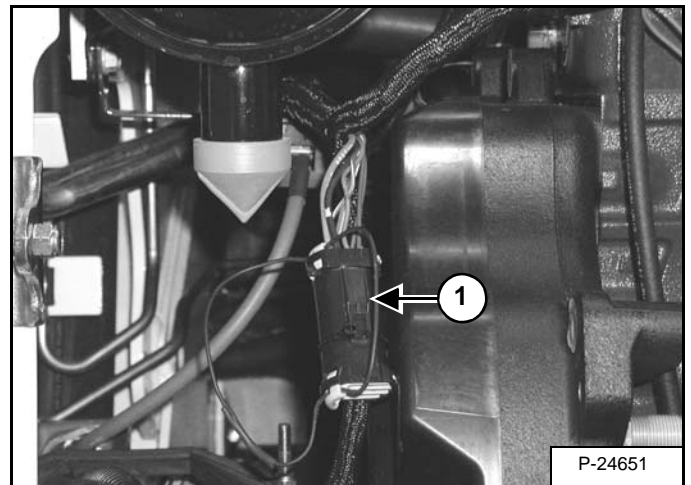
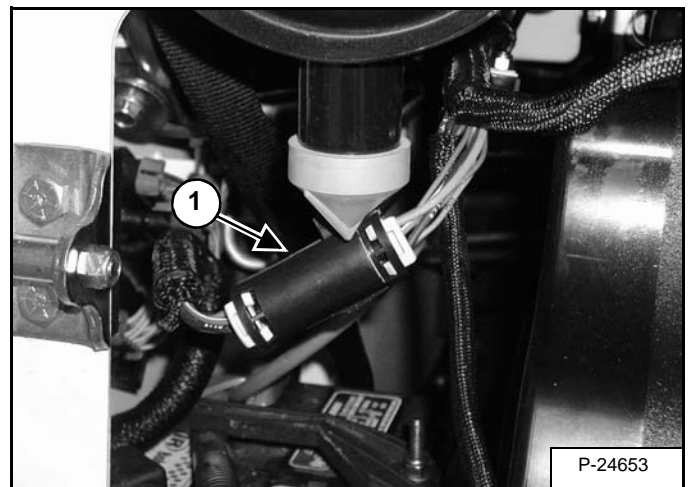

Figure 10-60-3



Lift and block the loader. (See Procedure on Page 10-10-1.)

Raise the lift arms (if required by the procedure) and install an approved lift arm support device. (See Installing Lift Arm Support Device on Page 10-20-1.)

Raise the operator cab (if required by the procedure). (See Raising The Operator Cab on Page 10-30-1.)

Open the rear door of the loader.

Remove the plug (Item 1) [Figure 10-60-2] or disconnect the attachment control harness (Item 1) [Figure 10-60-3] if connected.

## REMOTE START (CONT'D)

### Procedure (Cont'd)

Figure 10-60-4

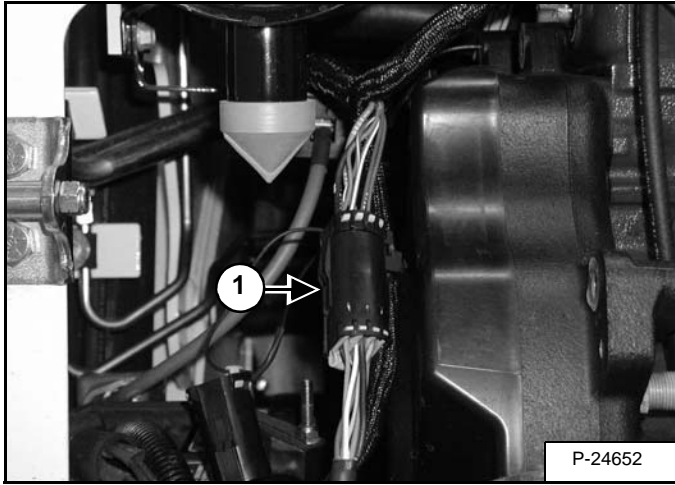

Connect the remote start tool to the engine harness connector (Item 1) [Figure 10-60-4].

**NOTE:** The key switch on the right-hand side operator panel must be in the off position or the Remote Start Kit will not operate.

Figure 10-60-5

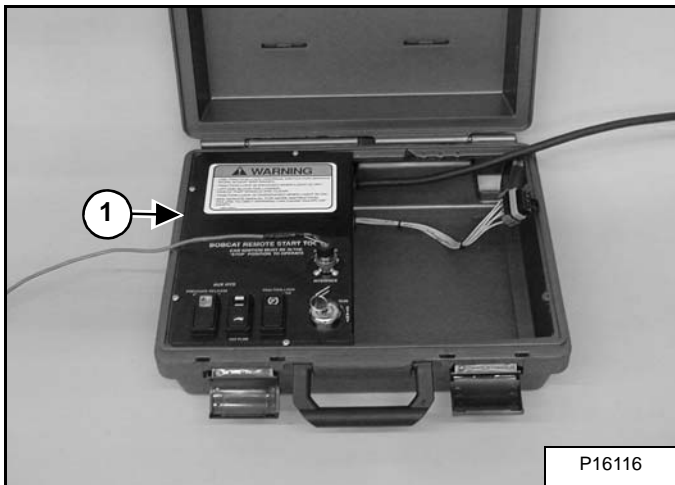

The remote start tool (Item 1) [Figure 10-60-5] has three rocker switches.

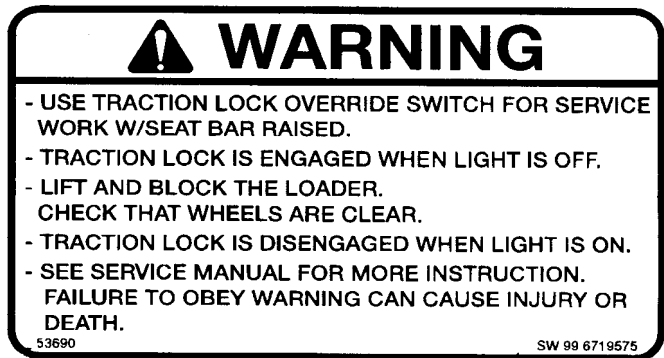
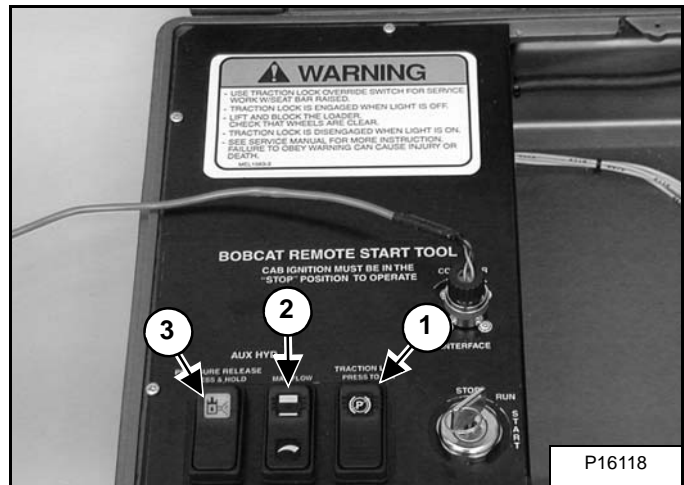

Figure 10-60-6



The traction lock switch (Item 1) [Figure 10-60-6] is used to turn traction lock on or off. Push the switch to the override position. The switch will illuminate to indicate traction lock **VERRIDE**, in this position the wheels are able to turn.

The maximum flow/variable flow switch (Item 2) [Figure 10-60-6] is used to activate the auxiliary hydraulics. Pressing the switch once will activate variable flow. Pressing the switch again will activate maximum flow. The switch will illuminate to indicate which flow rate is active. Pressing the switch a third time will turn the flow OFF. The switch is used when checking pressures and flow rate.

The auxiliary pressure release (Item 3) [Figure 10-60-6] is used to release hydraulic pressure to the right hand auxiliary and/or rear auxiliary couplers **ONLY**.

**NOTE:** With the engine running; pushing and holding the pressure release switch will cause the engine to stop in three seconds. To relieve the pressure; continue to press the switch after the engine has stopped.

## REMOTE START (CONT'D)

### Procedure (Cont'd)

Figure 10-60-7

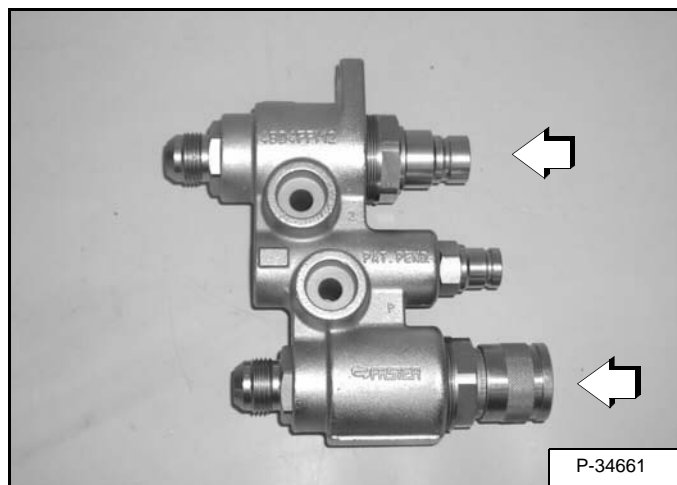

Push the couplers on the front auxiliary block toward the block and hold for five seconds to release the front auxiliary pressure [Figure 10-60-7].

## SERVICE SCHEDULE

### Chart

Maintenance work must be done at regular intervals. Failure to do so will result in excessive wear and early failures. The service schedule is a guide for correct maintenance of the Bobcat loader.

 <b style="font-size: 24pt; margin-left: 10px;">WARNING</b>	<p><b>Instructions are necessary before operating or servicing machine. Read and understand the Operation &amp; Maintenance Manual, Operator's Handbook and signs (decals) on machine. Follow warnings and instructions in the manuals when making repairs, adjustments or servicing. Check for correct function after adjustments, repairs or service. Untrained operators and failure to follow instructions can cause injury or death.</b></p>
<b>W-2003-0903</b>	

SERVICE SCHEDULE		HOURS					
ITEM	SERVICE REQUIRED	8-10	50	100	■ 250	■ 500	■ 1000
Engine Oil	Check the oil level and add oil as needed.						
Engine Air Filter and Air System	Check display panel. Service only when required. Check for leaks and damaged components.						
Engine Cooling System	Clean debris from oil cooler, radiator & grill. Check coolant level COLD and add premixed coolant as needed.						
Tires	Check for damaged tires and correct air pressure. Inflate to MAXIMUM pressure shown on sidewall of tire.						
Seat Belt, Seat Bar, Control Interlocks and Seat Belt Retractors	Check the condition of seat belt. Check the seat bar and control interlocks for correct operation. Clean dirt and debris from moving parts. Clean or replace seat belt retractors as needed.						
Safety Signs and Safety Treads	Check for damaged signs (decals) and safety treads. Replace any signs or safety treads that are damaged or worn.						
Indicators & Lights	Check for correct operation of all indicators and lights.						
Operator Cab	Check the fastening bolts, washers and nuts. Check the condition of the cab.						
Lift Arms, Cylinders, Bob-Tach Pivot Pins and Wedges	Lubricate with multi-purpose lithium based grease.						
Fuel Filter	Remove the trapped water.						
Heater Filters	Clean or replace filters as needed during heating/cooling season.						
Bobcat Interlock Control System (BICS™)	Check the four (4) BICS™ indicator lights and functions are activated. See details in this Manual.						
Hydraulic Fluid, Hoses and Tubelines	Check fluid level and add as needed. Check for damage and leaks. Repair or replace as needed.						
Final Drive Trans. (Chaincase),	Check oil level. Check for correct operation. Repair or adjust as needed.						
Foot Pedals or Hand Controls and Steering Levers	Check for correct operation. Repair or adjust as needed.						
Wheel Nuts	Check for loose wheel nuts and tighten to correct torque. (See Wheel Nuts on Page 10-170-1.)	☐					
Parking Brake	Check operation.						
Spark Arrestor Muffler	Clean the spark chamber.						
Battery	Check cables, connections and electrolyte level. Add distilled water as needed.						
Steering Lever Pivots	Grease two fittings.						
Engine/Hydrostatic Drive Belt	Check for wear or damage. Adjust as needed.		*				
Fan Drive Gearbox	Check gear lube level. Add as needed.						
Alternator Belt	Check belt tension and adjust as needed.						
Engine Oil and Filter	Replace oil and filter. Use CD or better grade oil and Bobcat filter.		^				
Fuel Filter	Replace the filter element.						
Bobcat Interlock Control System (BICS™)	Check the function of the lift arm by-pass control						
Hydraulic Reservoir Breather Cap	Replace the reservoir breather cap.						
Hyd./Hydro. Filter	Replace the filter element.		●				
Hydraulic Reservoir	Replace the fluid						
Final Drive Trans. (Chaincase)	Replace the fluid						
Case Drain Filters	Replace the filters						

☐ Check wheel nut torque every 8 hours for the first 24 hours.

\* Inspect the new belt after first 50 hours.

● Replace filter element after the first 50 hours and when the transmission warning light comes ON.

^ First oil and filter change must occur at 50 hours; 250 hours thereafter.

■ Or every 12 months.

## AIR CLEANER SERVICE

### Checking

Figure 10-80-1

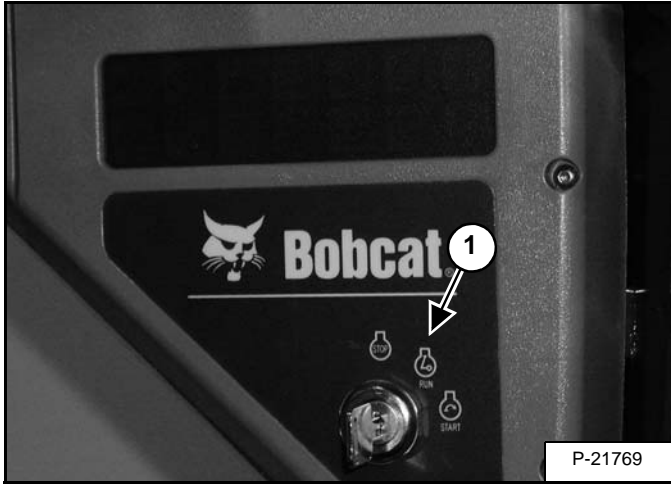

It is important to change the air filter element only when the Air Cleaner icon in the right panel is ON (Item 1) [Figure 10-80-1] and you hear three beeps from the alarm.

Replace the inner filter every third time the outer filter is replaced or as indicated on Contents Page 70-01.

Figure 10-80-2

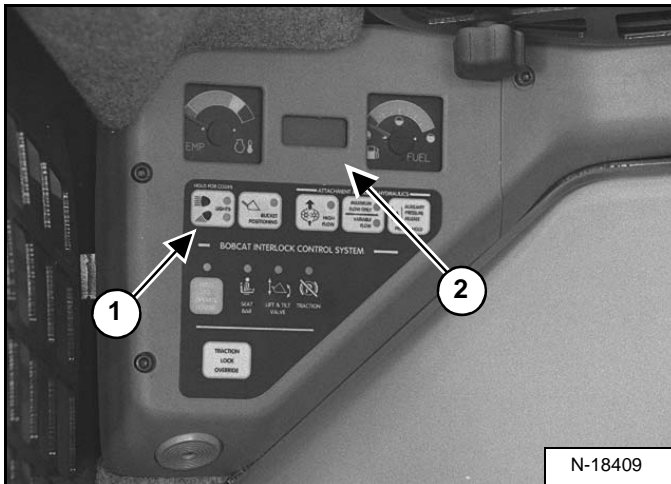

Press and hold the LIGHT Button (Item 1) [Figure 10-80-2] for two seconds.

If the filter element needs replacement, the CODE [01-17] (**Air Filter Plugged**) will show in the HOURMETER / CODE DISPLAY (Item 2) [Figure 10-80-2].

## Replacing Filter Element(s)

### OUTER FILTER

Figure 10-80-3

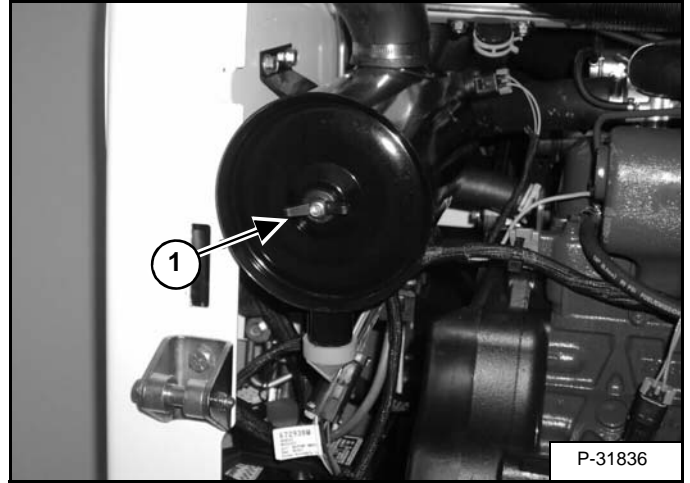

Remove the wing nut (Item 1) [Figure 10-80-3] and remove the dust cover.

Figure 10-80-4

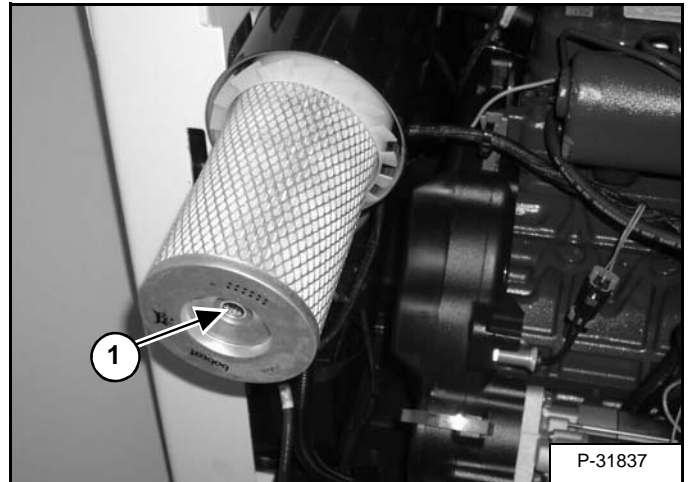

Remove the wing nut (Item 1) [Figure 10-80-4] from the outer filter element and the outer filter element.

## AIR CLEANER SERVICE (CONT'D)

### Replacing Filter Element(s) (Cont'd)

Figure 10-80-5

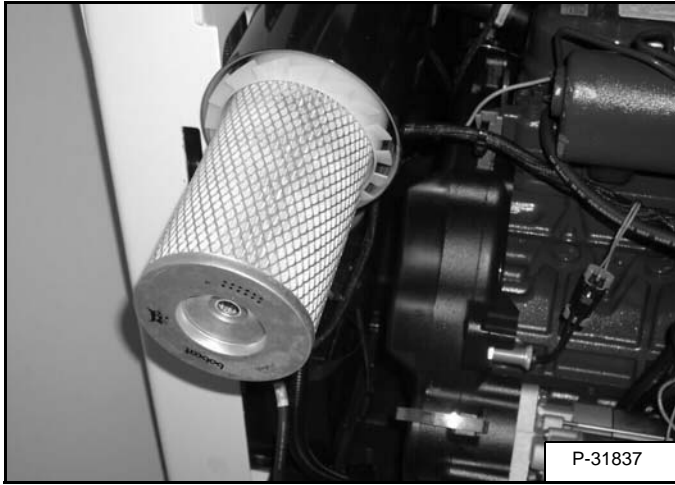

**NOTE:** Be sure all sealing surfaces are clean.

Install the new filter element and washer. Tighten the wing nut.

**NOTE:** Be sure sealing washer is in place on each wing nut [Figure 10-80-4].

Install the dust cover and tighten the wing nut.

Check the air intake hose and the air cleaner housing for damage. Make sure all connections are tight.

## INNER FILTER

Figure 10-80-6

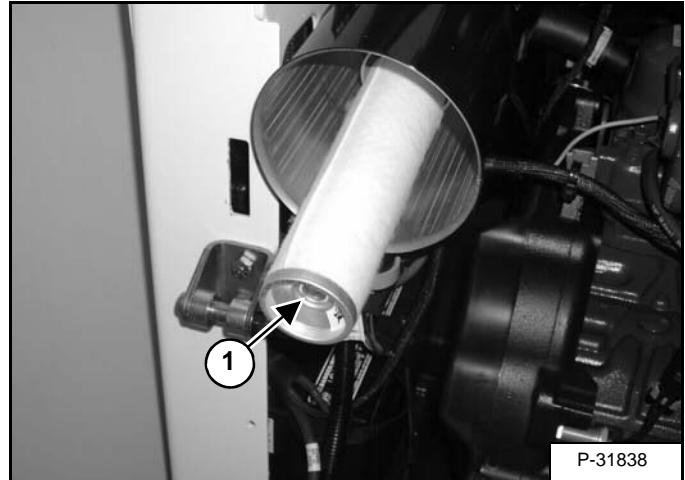

Only replace the inner filter element under the following conditions:

- Replace the inner filter element every third time the outer filter is replaced.
- After the outer element has been replaced, start the engine and run at full RPM. If the HOURMETER / CODE DISPLAY shows [01-17] (Air Filter Plugged), replace the inner filter element.

Remove the inner filter wing nut [Figure 10-80-6].

Remove the inner filter (Item 1) [Figure 10-80-6].

Install a new filter and tighten the wing nut.



**Suggest:**

**If the above button click is invalid.**

**Please download this document**

**first, and then click the above link**

**to download the complete manual.**

**Thank you so much for reading**

## ENGINE COOLING SYSTEM

### Cleaning The Cooling System

# ! WARNING

Wear safety glasses to prevent eye injury when any of the following conditions exist:

- When fluids are under pressure.
- Flying debris or loose material is present.
- Engine is running.
- Tools are being used.

W-2019-1285

Figure 10-90-1

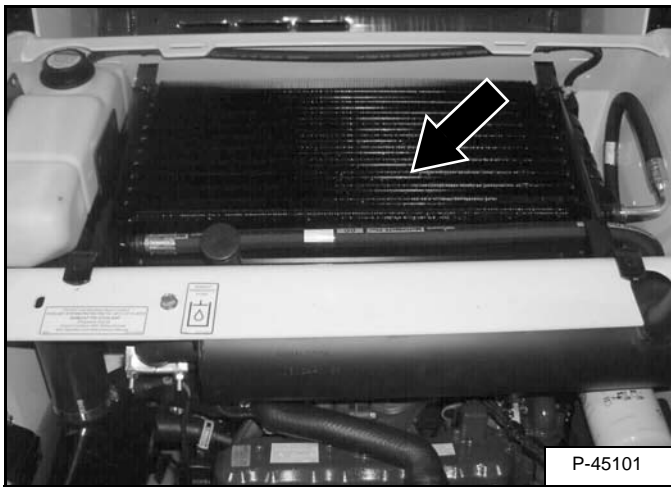

Check the cooling system every day to prevent overheating, loss of performance or engine damage.

Open the rear door and remove the rear grill. (See Removal And Installation on Page 50-60-1.)

Use air pressure or water pressure to clean the top of the oil cooler [Figure 10-90-1].

# IMPORTANT

## AVOID ENGINE DAMAGE

Always use the correct ratio of water to antifreeze.

Too much antifreeze reduces cooling system efficiency and may cause serious premature engine damage.

Too little antifreeze reduces the additives which protect the internal engine components; reduces the boiling point and freeze protection of the system.

Always add a premixed solution. Adding full strength concentrated coolant can cause serious premature engine damage.

I-2124-0497

Figure 10-90-2

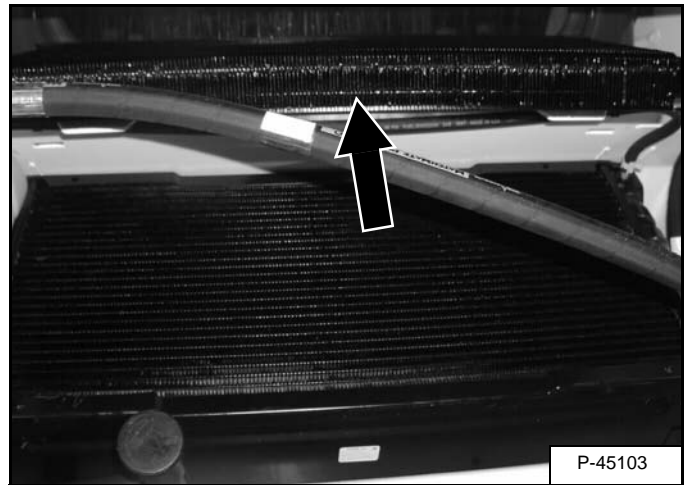

Raise the air conditioning condenser (if equipped) and the oil cooler and clean the top of the radiator [Figure 10-90-2].

Lower the oil cooler on the loader frame.

Check cooling system for leaks.

Lower the rear grill and close the rear door.

**<https://www.ebooklibonline.com>**

Hello dear friend!

Thank you very much for reading.

Enter the link into your browser.

The full manual is available for immediate download.

**<https://www.ebooklibonline.com>**